





Assembly Instruction

⚠ WARNING:

- Read all instructions carefully and completely before assembly and use. Retain for future reference.
- DO NOT use power tools.
- DO NOT overtighten hardware.
- Periodically check all hardware and re-tighten as necessary.
- DO NOT use product if any component becomes damaged.
- For residential (non-commercial) use only.
- DO NOT sit or stand on product. Use only for intended purpose.
- DO NOT exceed 80lbs for the tabletop, evenly distributed.

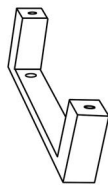
Parts List

Check all parts before assembly

A. <u>Item Body</u>  <p style="text-align: right;">X1</p>		B. <u>Leg</u>  <p style="text-align: right;">X1</p>	
H1. <u>Hex bolt</u>  <p style="text-align: center;">*4(+1 extra)</p>	H2. <u>Washer</u>  <p style="text-align: center;">*4(+1 extra)</p>	H3. <u>Foot pad</u>  <p style="text-align: center;">*1</p>	H4. <u>Allen key</u>  <p style="text-align: center;">*4</p>

Step 1: Put the Tabletop (A) on a soft surface to protect the finish.

Attach the Legs (B) with Hex bolts (H1) and Washers (H2) using Allen key (H4) as below photo shown.

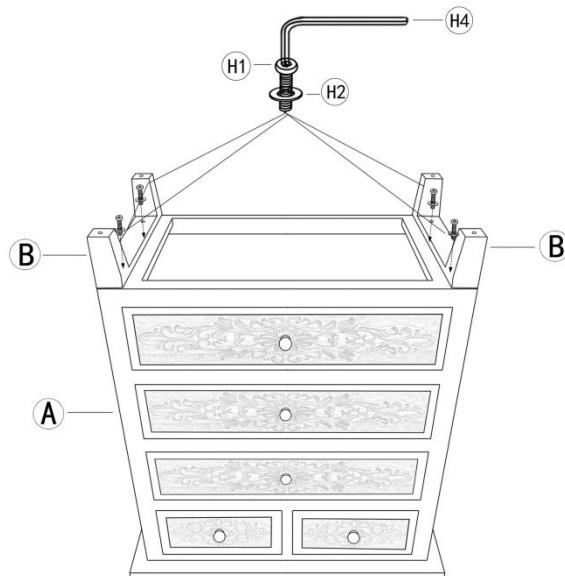

Step 2: Attach the Foot pads (H3) to the bottom of all Legs as shown below.



Assembly finished.



Notice:

If you have any questions about your purchase or any other product for sale, please contact Service@jimsidea.com with your order ID, our customer service representatives are available to help.