

USE AND CARE GUIDE

OUTDOOR WALL LANTERN

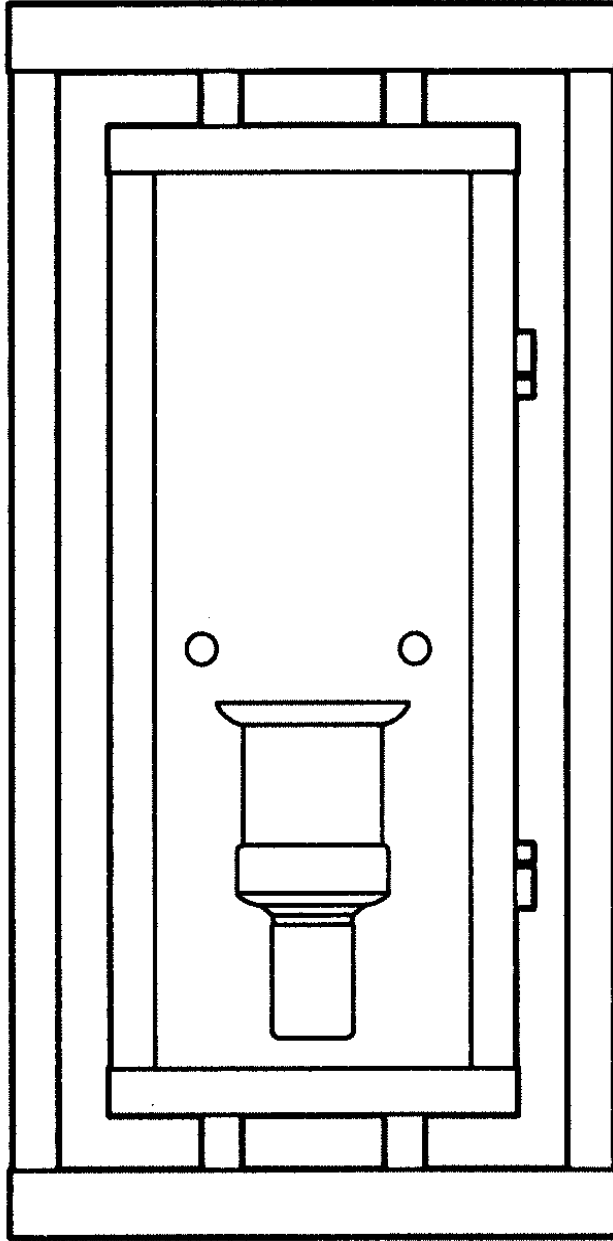

Questions, problems, missing parts? Before returning to the store

Table of Contents

Table of Contents.....	2	Hardware Included.....	3
Safety Information.....	2	Package Contents.....	4
Warranty.....	2	Installation	5
Pre-Installation	3	Operation	6
Planning Installation.....	3	Care and Cleaning	6
Tools Required.....	3	Troubleshooting.....	6

Safety Information

- Consult a qualified electrician if you have any electrical questions.



CAUTION: Inspect the wire insulation for any cuts, abrasions, or exposed copper that may have resulted during shipping. If there is a defect in the wire, do not attempt installation. Please call our Customer Service Team



WARNING: Before starting installation of this fixture or removal of a previous fixture, disconnect the power by turning off the circuit breaker or by removing the fuse at the fuse box.

Warranty

The manufacturer warrants this lighting fixture to be free from defects in materials and workmanship for a period of one (1) year from date of purchase. This warranty applies only to the original consumer purchaser and only to products used in normal use and service. If this product is found to be defective, the manufacturer's only obligation, and your exclusive remedy, is the repair or replacement of the product at the manufacturer's discretion, provided that the product has not been damaged through misuse, abuse, accident, modifications, alterations, neglect, or mishandling. This warranty shall not apply to any product that is found to have been improperly installed, set-up, or used in any way not in accordance with the instructions supplied with the product. This warranty shall not apply to a failure of the product as a result of an accident, misuse, abuse, negligence, alteration, faulty installation, or any other failure not relating to faulty material or workmanship. This warranty shall not apply to the finish on any portion of the product, such as surface and/or weathering, as this is considered normal wear and tear. The manufacturer does not warrant and specially disclaims any warranty, whether express or implied, of fitness for a particular purpose, other than the warranty contained herein. The manufacturer specifically disclaims any liability and shall not be liable for any consequential or incidental loss or damage, including but not limited to any labor / expense costs involved in the replacement or repair of said product.

Pre-Installation

PLANNING INSTALLATION

- Read all instructions before installation.
- To avoid damaging this product, assemble it on a soft, non-abrasive surface, such as carpet or cardboard.
- Keep your receipt and these instructions for proof of purchase.

TOOLS REQUIRED



Ladder



Safety glasses



Electrical tape

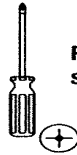

Phillips screwdriver



Flat blade screwdriver



Pliers

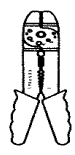

Wire strippers

HARDWARE INCLUDED



NOTE: Hardware not shown to actual size.

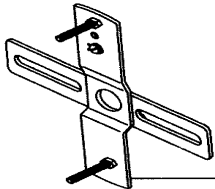

AA



BB



CC



DD

Part	Description	Quantity
AA	Mounting unit	1
BB	Mounting screw	2
CC	Wire nut	3
DD	Cap nut	2

Operation

1 Turning the light on

- Turn the light switch on to activate the fixture.

Care and Cleaning

- Clean the lamp with a soft, dry cloth.
- Do not use any cleaners with chemicals, solvents, or harsh abrasives.

Troubleshooting

Problem	Possible Cause	Solution
The bulb will not light.	The bulb is burned out.	Replace the light bulb.
	The power is off.	Ensure the power supply is On.
	There is a faulty wire connection.	Check the wiring.
	The circuit breaker is off.	Ensure the circuit breaker is in the On position.
The fuse blows or circuit breaker trips when the light is turned on.	There are crossed wires or the power wire is grounding out.	Check the wire connections. Contact a qualified electrician or call the Customer Service Team

Pre-Installation (continued)

PACKAGE CONTENTS

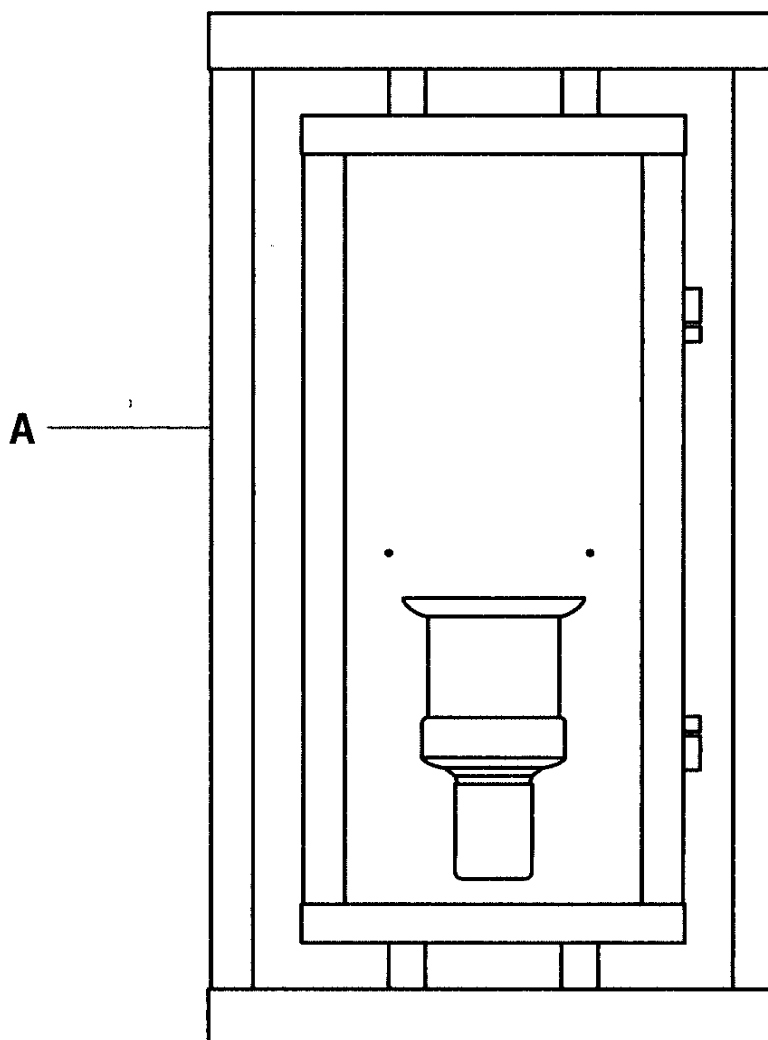

Part	Description	Quantity
A	Light fixture	1

Installation

1 Attaching the mounting unit to the junction box

- Attach the mounting unit (AA) to the junction box (not included) with mounting screws (BB).

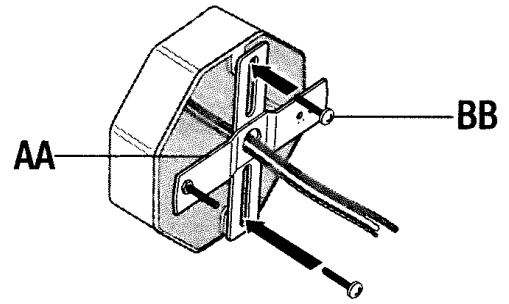

NOTE: The pre-installed support screws on the mounting unit (AA) should protrude out away from the junction box.

2 Making the electrical connections

- Connect the copper wire from the light fixture (A) to the mounting unit (AA) by securing it with the pre-installed ground screw.
- Connect the black to black (power), the white to white (neutral), and copper wire to ground wire with the wire nuts (CC) and secure the wire nuts (CC) with electrical tape (not included).

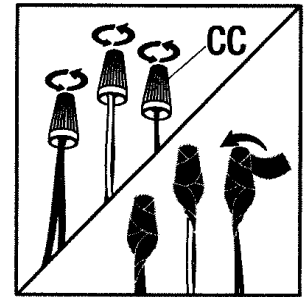
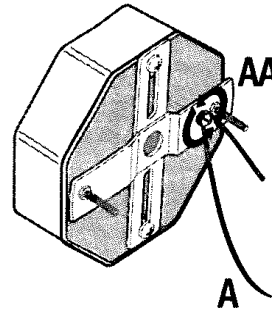

NOTE: If the wires from the fixture are the same color, attach the side with markings or letters to the black (positive) wire and the other to the white (neutral) wire.

3 Securing the light fixture to the junction box

- Pull up the latch and open the door on the right side of the light fixture (A) to access the interior.
- Secure the light fixture (A) to the junction box by placing it over the pre-installed screws on the mounting unit (AA) and securing it with the cap nuts (DD).

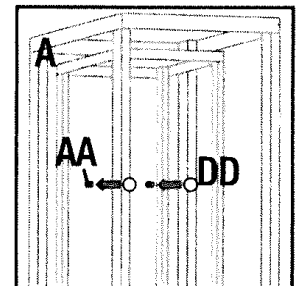
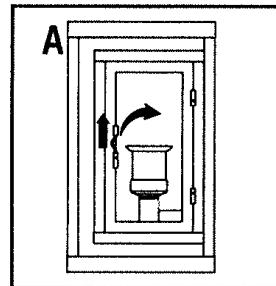

NOTE: The fixture is designed to be mounted facing up for the bottom drainage holes to be implemented.

4 Installing the light bulbs

- Install one 60W medium base light bulb (not included).

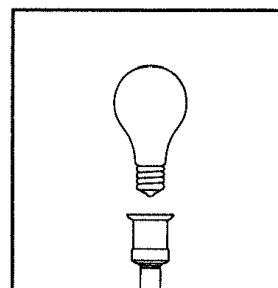

GUIDE D'UTILISATION ET D'ENTRETIEN

LANTERNE EXTÉRIEUR

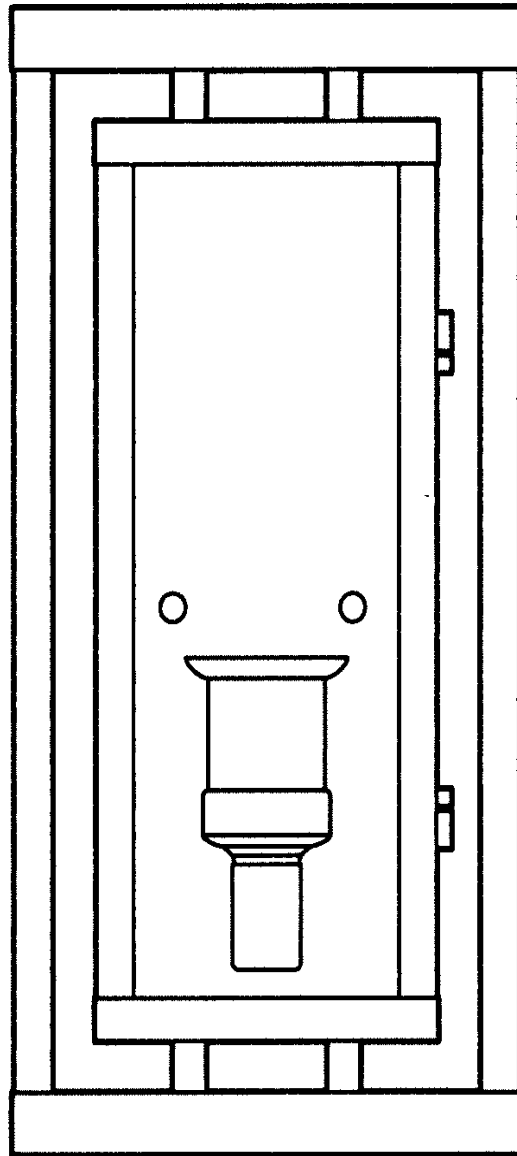

Questions, problèmes, pièces manquantes? Avant de le retourner au magasin,

Table des matières

Table des matières	2	Matériel Inclus.....	3
Mesures de sécurité	2	Contenu	4
Garantie	2	Installation	5
Pré-installation	3	Fonctionnement.....	6
Planification De L'installation	3	Entretien et nettoyage	6
Outils Requis.....	3	Dépannage	6

Mesures de sécurité

- Consulter un électricien qualifié si vous avez toute question concernant l'installation électrique.



MISE EN GARDE : Inspecter l'isolation du fil pour toute usure ou gonflements anormaux, ou fils de cuivre exposés qui peuvent avoir été causés au cours de l'expédition. Si il y a un défaut dans le fil, ne pas tenter de l'installer. Veuillez appeler notre équipe de service à la clientèle



AVERTISSEMENT : Avant de commencer l'installation de ce luminaire ou le retrait de l'ancien luminaire, débrancher l'alimentation en désactivant le disjoncteur ou en retirant le fusible de la boîte à fusible.

Pré-installation

PLANIFICATION DE L'INSTALLATION

- Lire toutes les instructions avant l'assemblage.
- Pour éviter d'endommager le produit, l'assembler sur une surface douce, abrasive comme un tapis ou un morceau de carton.
- Conservez votre reçu et ces instructions comme preuve d'achat.

OUTILS REQUIS



Échelle



Lunettes de sécurité



Ruban électrique



Tournevis Phillips

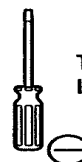

Tournevis à lame plate



Pince



Pince à dénuder

MATÉRIEL INCLUS



NOTE : Matériel non représenté à la taille réelle.

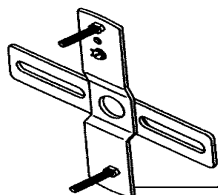

AA



BB



CC

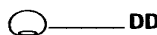

DD

Pièce	Description	Quantité
AA	Unité de montage	1
BB	Vis de fixation	2
CC	Écrou de fil	3
DD	Écrou de capuchon	2

Fonctionnement

1

Allumer la lumière

- Activer le commutateur d'éclairage pour activer le luminaire.

Entretien et nettoyage

- Nettoyer la lampe avec un linge propre et doux.
- N'utilisez pas de nettoyeurs contenant des produits chimiques, solvants ou abrasifs.

Dépannage

Problème	Cause probable	Solution
L'ampoule ne s'allume pas.	L'ampoule est grillée.	Remplacer l'ampoule.
	L'alimentation est coupée.	S'assurer que l'alimentation est activée.
	Il y a un cordon d'alimentation défectueux.	Vérifier le câblage.
	Le disjoncteur est désactivé.	S'assurer que le disjoncteur est en position de marche.
Le fusible saute ou le disjoncteur se déclenche lorsque la lumière s'allume.	Il y a des fils croisés ou le fil d'alimentation est hors de la mise à la terre.	Vérifier les connexions des câbles. Contacter un électricien qualifié ou appeler le service à la clientèle

Pré-installation (suite)

CONTENU

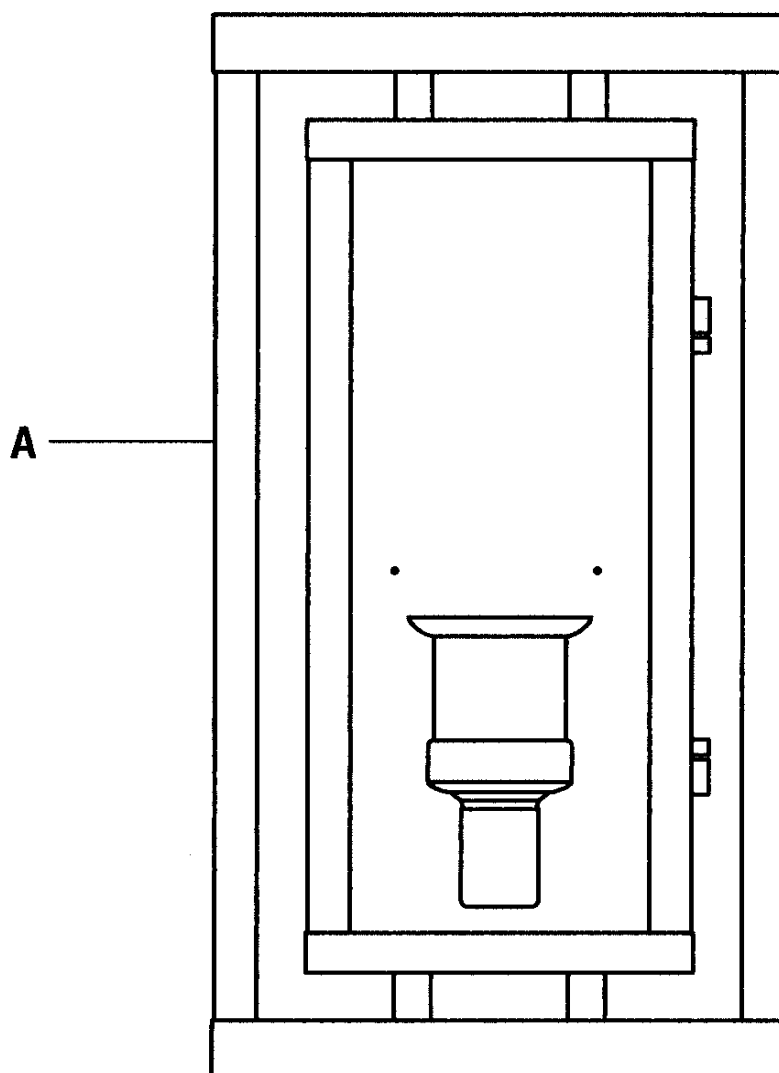

Pièce	Description	Quantité
A	Luminaire	1

Installation

1 Fixation du support de fixation à la boîte de jonction

- ❑ Fixer le support de fixation (AA) à la boîte de jonction (non inclus) avec les vis de fixation (BB).



REMARQUE: Les vis de fixation préinstallées sur le support de fixation (AA) devraient dépasser de la boîte de jonction.

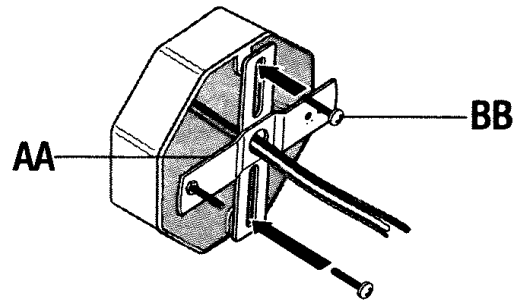

2 Effectuer le raccordement électrique

- ❑ Brancher le fil de cuivre du luminaire (A) au support de fixation (AA) en le fixant avec les vis de mise à la terre préinstallées.
- ❑ Brancher le fil noir au noir (alimentation), le fil blanc au blanc (neutre) et le fil de cuivre au fil de masse avec les capuchons de connexion (CC) et fixer solidement avec du ruban électrique (non inclus).



REMARQUE: Si les fils du luminaire sont de la même couleur, fixer le côté avec des marquages ou des lettres identifiant le fil noir (positif) et l'autre au fil blanc (neutre).

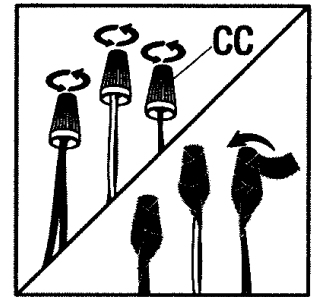
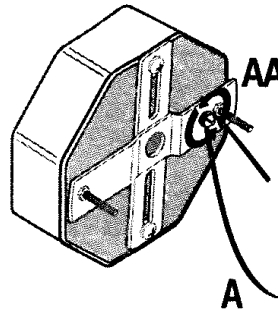

3 Fixation du luminaire

- ❑ Tirez le loquet vers le haut et ouvrez la porte sur le côté droit du luminaire (A) pour accéder à l'intérieur.
- ❑ Fixer le luminaire (A) à la boîte de jonction en le plaçant sur les vis de support sur le support de fixation (AA) et le fixer solidement avec l'écrou de capuchon (DD).



REMARQUE: Le luminaire est conçu pour être monté vers le haut pour que les trous de drainage du fond fonctionnent.

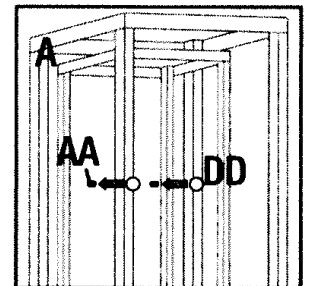
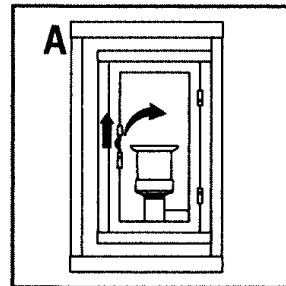

4 Installer l'ampoule

- ❑ Installer une ampoule moyenne à incandescence de puissance maximum de 60 watts (non incluses).

