

INSTRUCTION MANUAL

20x30FT Party Tent

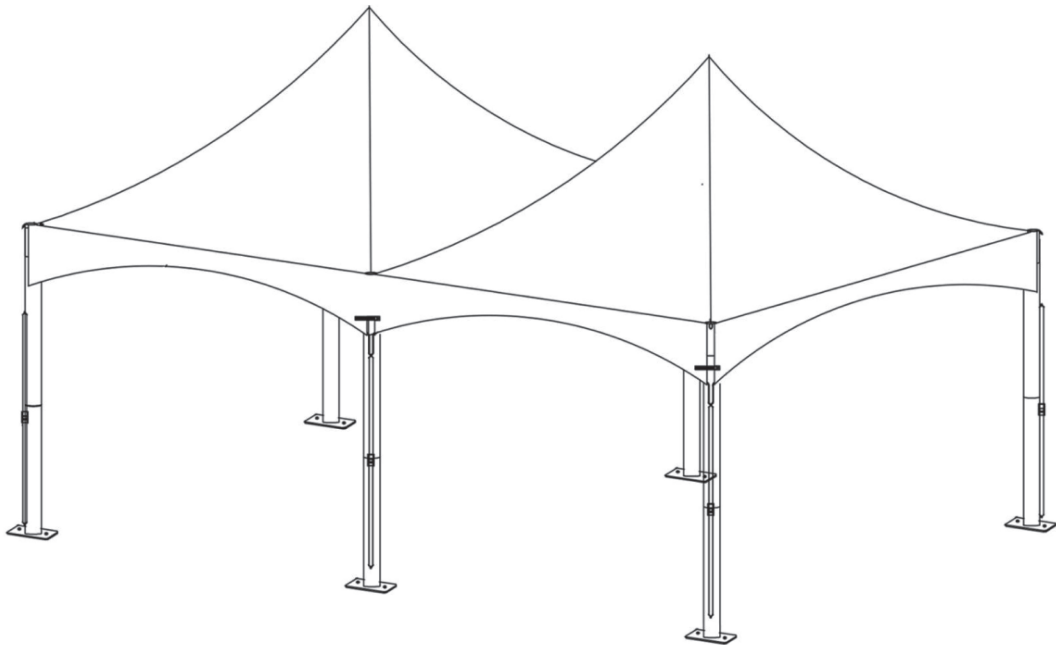







SKU: WQG109WH





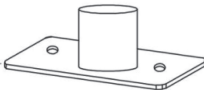



ATTENTION:

1. Please check the manual carefully and make sure you have received all the parts.
2. If there is any missing, please let us know the letter of the parts you need.
3. If there is any damage, please send clear photos to us, we will check and offer you best solution soon.

Box A

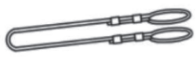
Part number	Photo	Part name	Quantity (pcs)
2		Pipe # 2	2
3		Pipe # 3	10
4		Inner sleeve pipe	6
6		Pipe # 6	2
7		Jacking pipe	2
10		Foot plate	6
18		Inner sleeve pipe	2
19		Pipe # 19	3
20		Pipe # 20	6

Box B

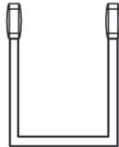
Part number	Photo	Part name	Quantity (pcs)
8		3-Way Connector	4
8		4-Way Connector	2
9		Wire rope	4
14		Roof	1
15		M6 X 50mm Screw	2
16		M6 X 60mm Screw	8
17		Screw nut	8
A		U-shaped steel rod	2



x 1









Allen wrench



x 1

Hex wrench

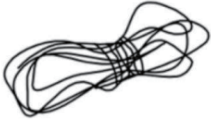
Box C

Part number	Photo	Part name	Quantity (pcs)
1		Pipe# 1	6
2		Pipe# 2	4
3		Pipe# 3	2
4		Inner sleeve	6
5		Pipe# 5	2
11		Tightener	6
12		Rope	4
13		Ground nail	16

STEP 1

Connect part(20) by inserting part (4) ,connect part(3) by inserting part (4) and connect part(19) by inserting part (18) to combine crossbars. Connect the crossbars to the connectors part (8 & 8) respectively as demonstrated in the diagram.

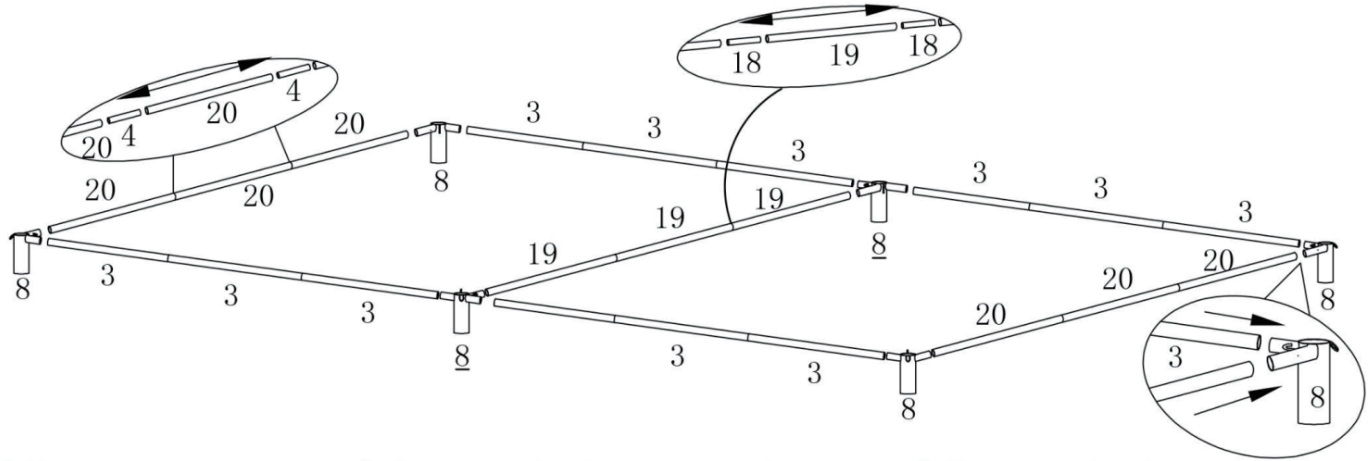

3 x 12	4 x 12	19 x 3	20 x 6	18 x 2	8 x 4	8 x 2
Pipe # 3	Inner sleeve pipe# 4	Pipe #19	Pipe #20	Inner sleeve pipe# 18	3-Way Connector	4-Way Connector

STEP 2

Hook each of the 2 sides of the wire rope (part 9) to the hooks of part (8) and part(8) as demonstrated in the diagram.

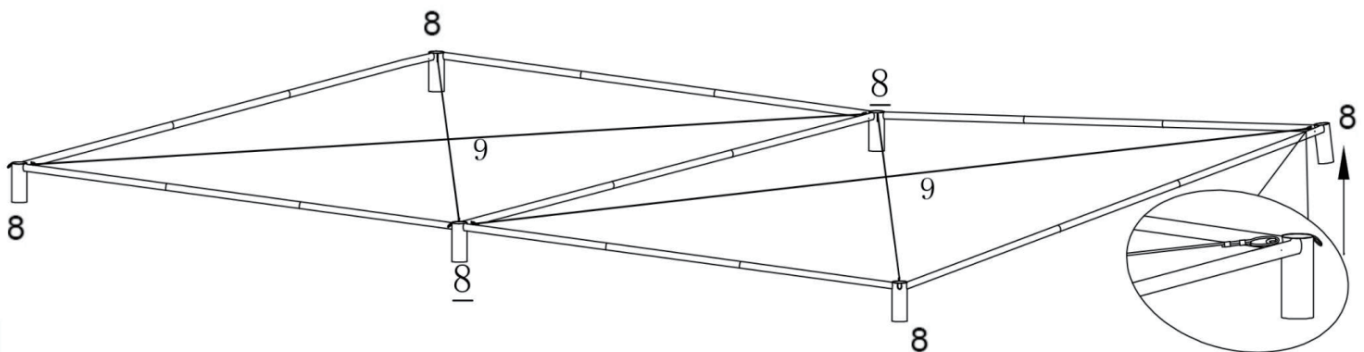

9 x 4
Wire rope

STEP 3

Cover the frame with the roof(part 14) .

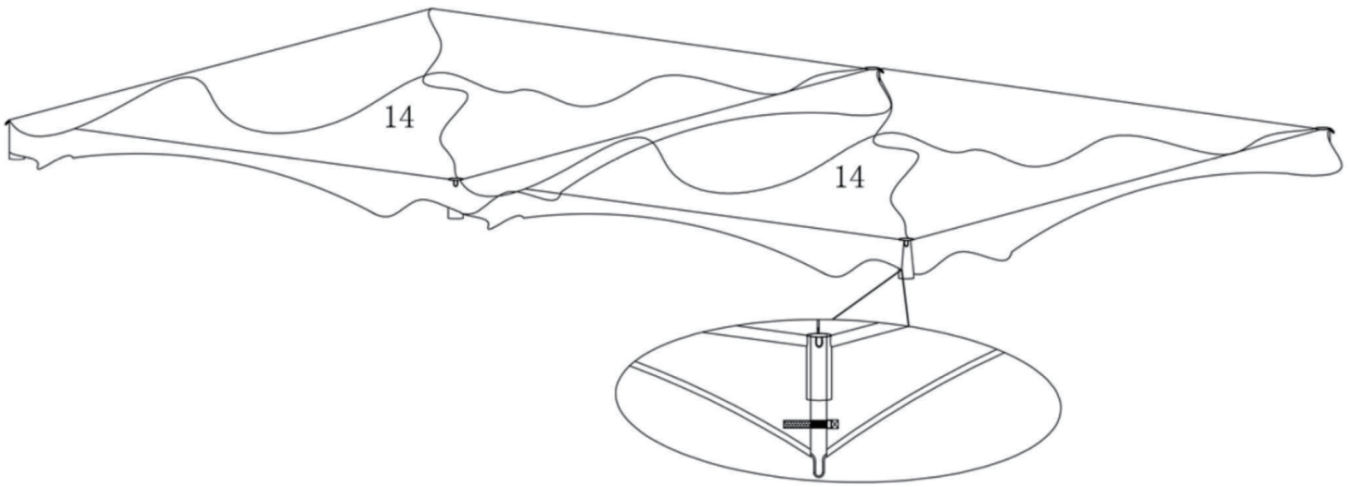

x 1

Roof

STEP 4

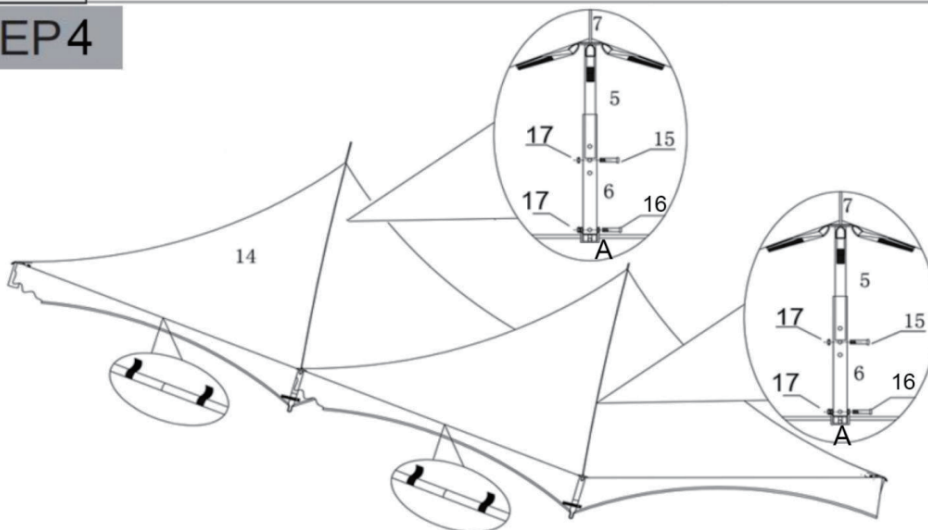

Secure the roof to the 4 sides of frame with velcro. Connect part (7), part(5) and part (6) by using screws (part 15&16) and screw nuts (part 17). Insert one side of the aligned pipe into the hole on the roof top. Secure the roof top to the 4 locking rings of part (7) with velcro sewed on the roof top. Slide the other side to the cross center of the wire ropes. Fix the U-shaped steel rod(part A)in the groove of the plastic cap from part(6).

Attention: it requires 3 persons in this step, 2 persons to lift up one side of the frame, one person to process other assembly procedures.

7 x 2	5 x 2	6 x 2	15 x 2	16 x 2	17 x 4	A x 2
Jacking pipe	Pipe # 5	Pipe # 6	M6 X 50mm Screw	M6 X 60mm Screw	Screw nut	

STEP 5

Attach 3 pcs of the part (2) to the connectors(part 8 and part 8) on one side.

Attention: it requires 3 persons in this step, 2 persons to lift up one side of the frame, one person to process other assembly procedures.

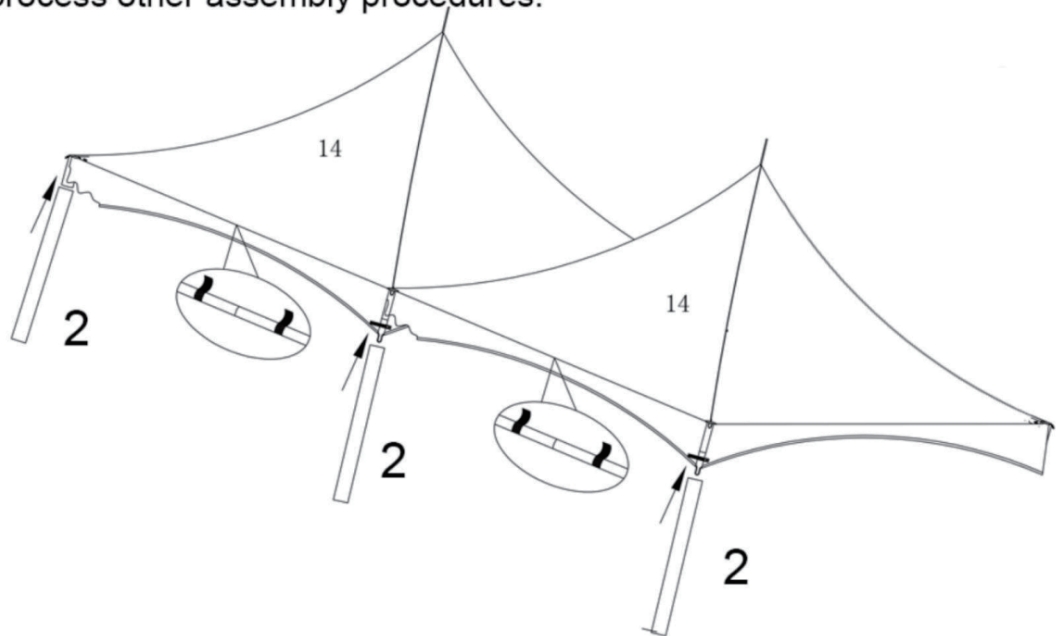

2 x 3

Pipe # 2

STEP 6

Attach 3 pcs part (1) on the same side to the part(2). Follow the same steps on the other side of the top frame. Connect part(10) to part (1) using screw (part 16) and screw nut (part 17).

Attention: it requires 3 persons in this step, 2 persons to lift up one side of the frame, one person to process other assembly procedures.

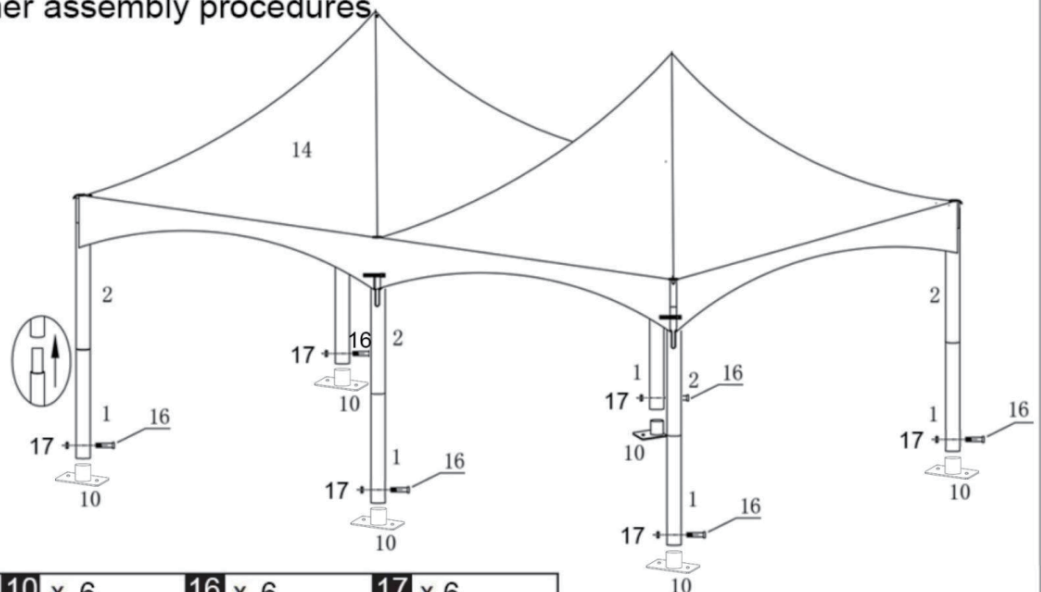

2 x 3

1 x 6

10 x 6

16 x 6

17 x 6

Pipe # 2

Pipe # 1

Footplate

M6X60mm
Screw

Screw nut

STEP 7

Connect the roof corners to the leg poles by connecting the 2 sides of part (11) as demonstrated in the diagram. Tighten the tighteners properly to ensure the roof is firmly secured to the leg poles.

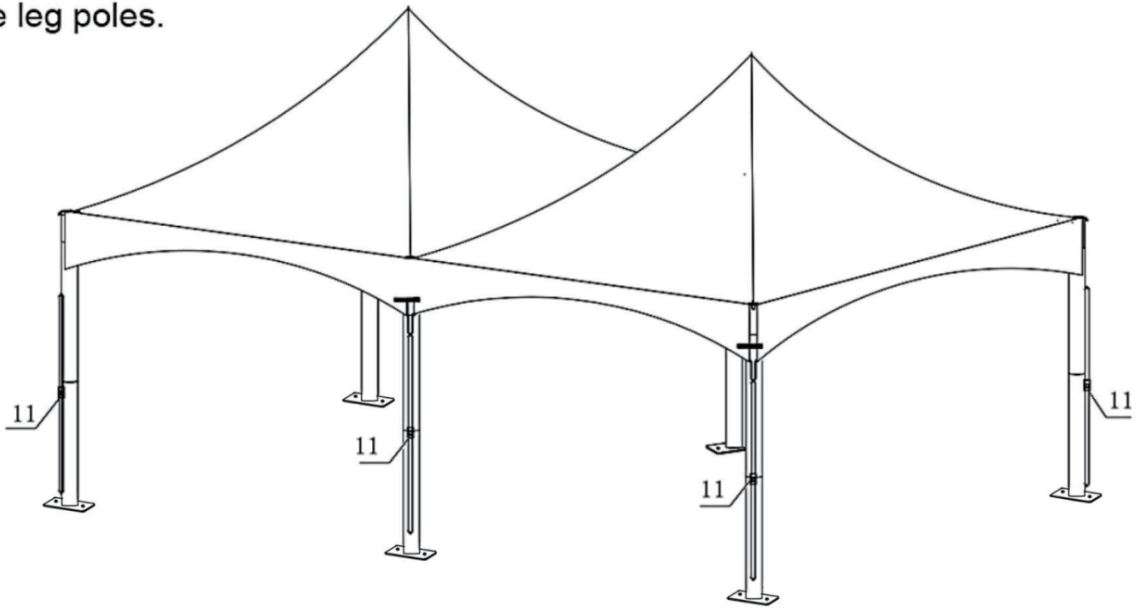

11 x 6

Tightener

STEP 8

Use ground nails (part 13) to secure the footplate (part 10) to the ground, then use ropes (part 12) and ground nails (part 13) to secure the party tent firmly to the ground.

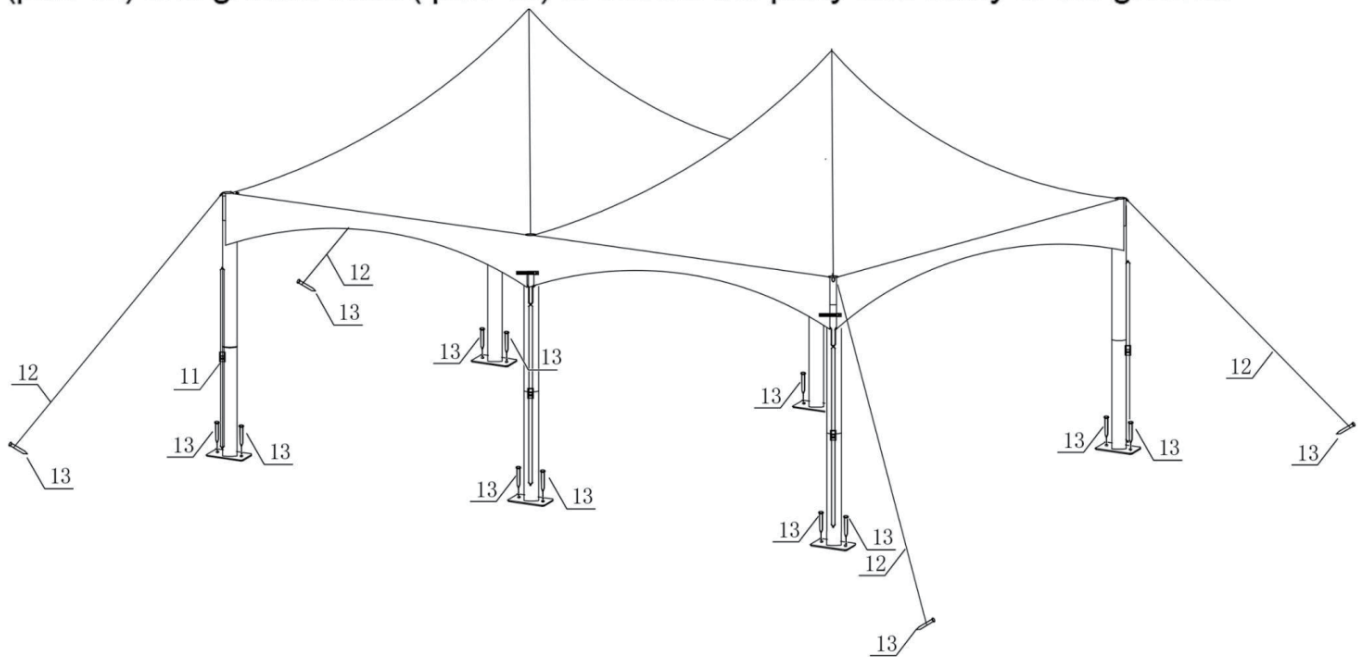

13 x 16

Ground nail

12 x 4

Rope

Now you can enjoy your party tent.