





(1)x1	(2)x5	(3)x1
		
Seat Cushion & mechanism	Casters	Base
(4)x1	(5)x1	(6)x1
		
Gas Lift	EXT	EXT



Insert and loosely tighten all screws. When assembly is completed, fully tighten all screws before using. This chair is only intended for sitting. Any other use will void the warranty.

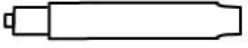
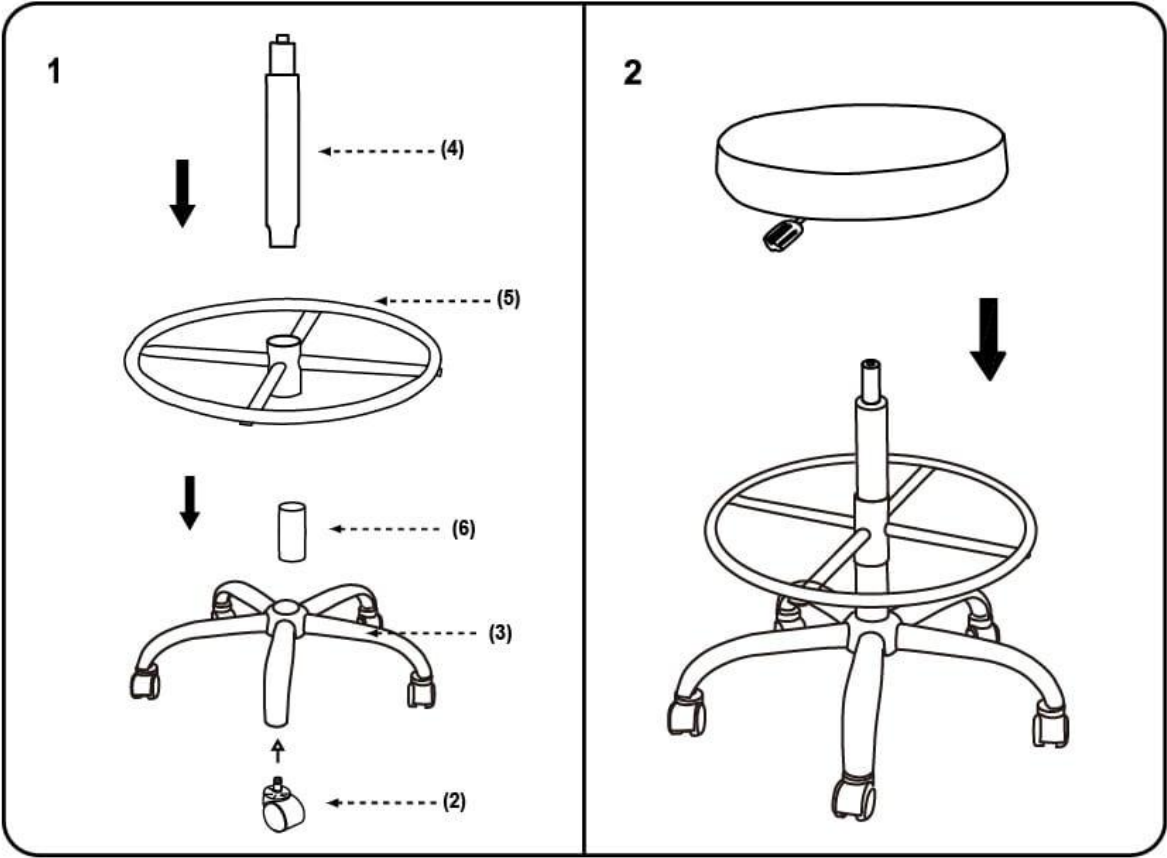