

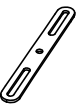

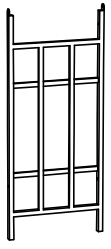

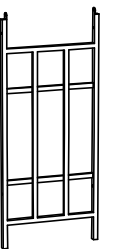
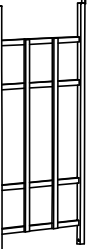

# ASSEMBLY INSTRUCTIONS

<p><b>1</b></p>  <p>4pcs</p>	<p><b>2</b></p>  <p>1pc</p>	<p><b>3</b></p>  <p>1pc</p>	<p><b>4</b></p>  <p>2pcs</p>	<p><b>B</b></p>  <p>1pc</p>	<p><b>C</b></p>  <p>1pc</p>	<p><b>D</b></p> 
<p><b>E</b></p> 	<p><b>a</b></p>  <p>M6*35mm 4pcs</p>	<p><b>b</b></p>  <p>M6*30mm 10pcs</p>	<p><b>c</b></p>  <p>2pcs</p>	<p><b>d</b></p>  <p>4pcs</p>	<p><b>e</b></p>  <p>1pc</p>	 <p>1pc</p>  <p>1pc</p>

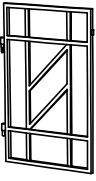
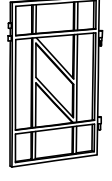
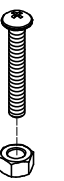
**1** **b** x2

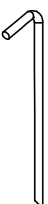
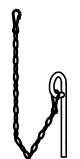
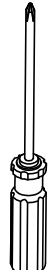

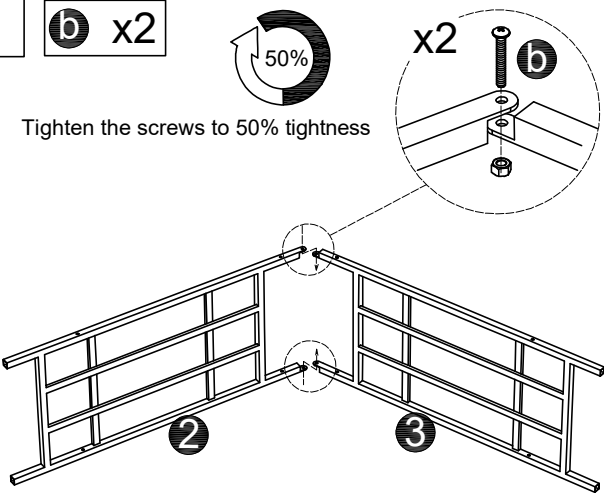
Tighten the screws to 50% tightness

**2** **a** x4

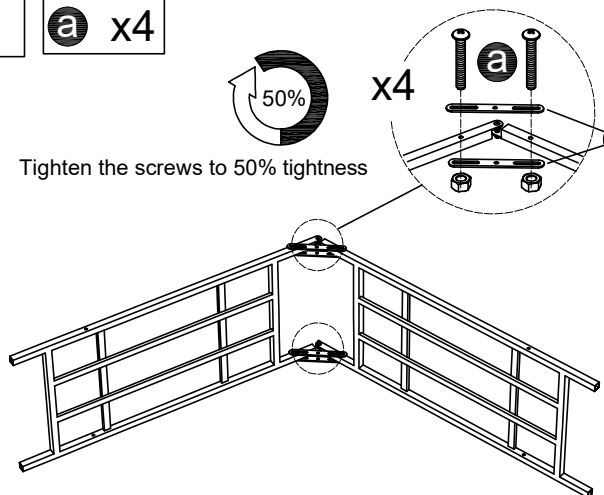

Tighten the screws to 50% tightness

**3** **b** x4

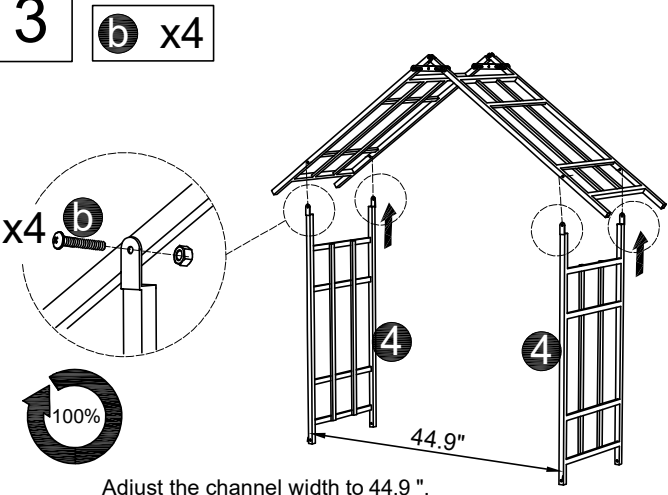

Adjust the channel width to 44.9", then tighten all screws to 100% tightness

**4** **b** x4

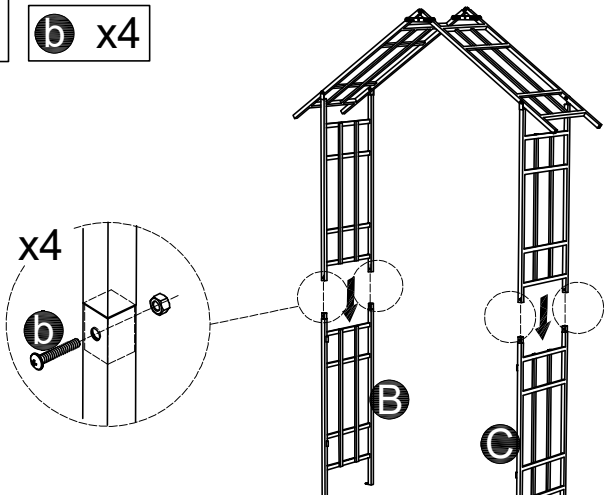

5

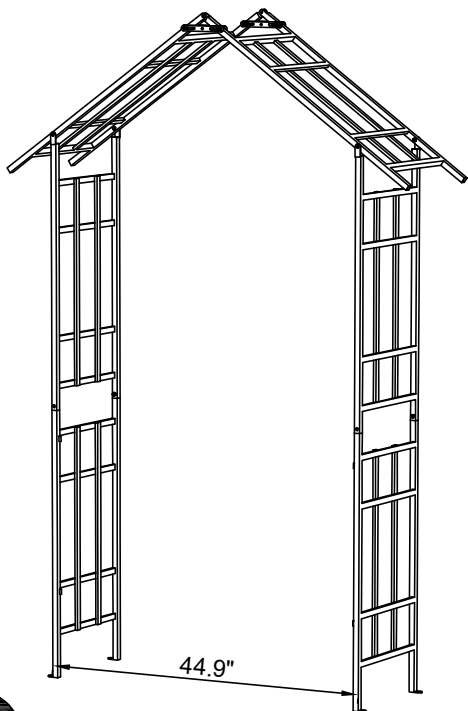

Tightenthe screws to 100% tightness

6

**c** x2

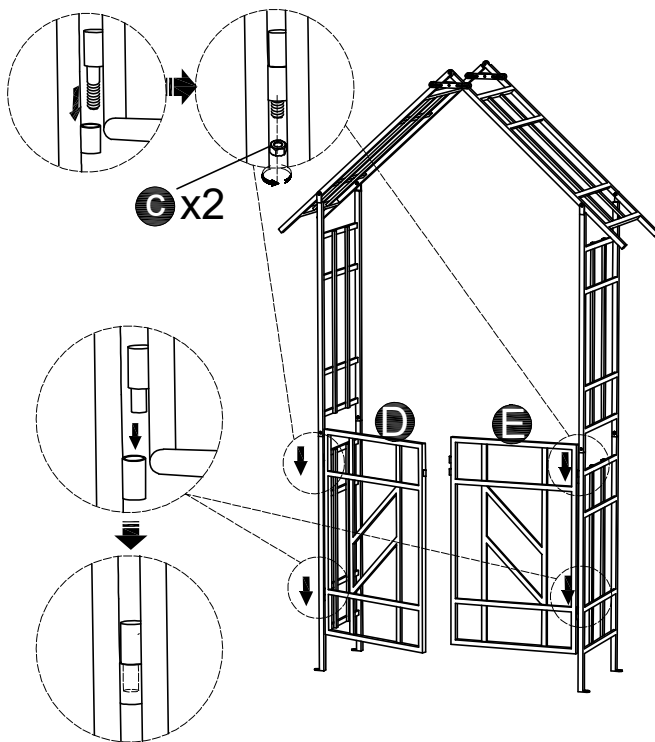

7

**e** x1

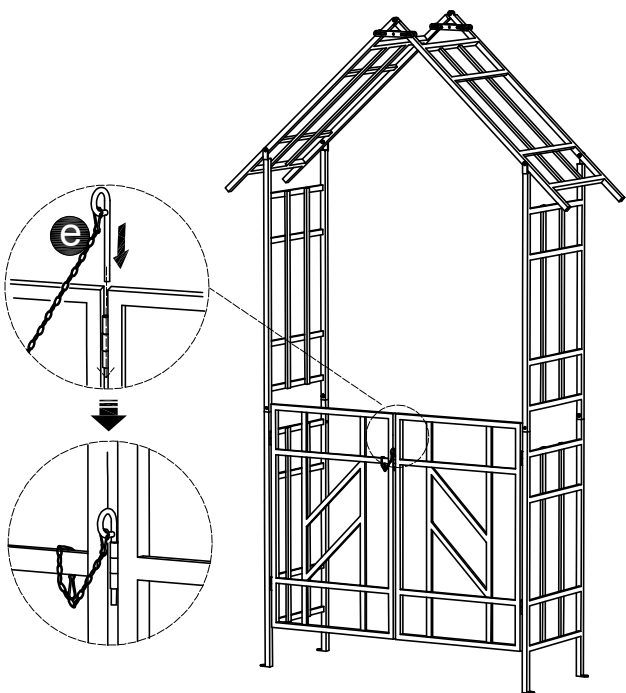

8

**d** x4

