



# **Rectangle LED Bathroom Mirror Manual**



# LED Wall-Mounted Mirror

---

## Instructions & Installation

### Statement

Please read this instruction carefully before installation, and refer to it again during the installation to ensure a safe and correct installation of the mirror.

### Compliance

All the electrical components used in this product are ETL LISTED. This product passed ETL certification.

### Electrical Safety Instructions

- ⚠️ INSTALLATION should be made by a qualified / registered electrician. DO NOT attempt to install it by yourself, as ROOMTEC will not be responsible for any damage caused during installation.
- ⚠️ According to IEEE regulations, this product is suitable for zone 2 and external zone, not zone 0 or zone 1. It is also not suitable for installation in saunas, steam rooms or shower cubicles.
- ⚠️ This product is only suitable for permanent installation, please do not plug in the power strip.
- ⚠️ Please make sure to keep the electrical supply off during installation and maintenance. It is recommended to pull out the fuse or switch off the circuit breaker before installation to disconnect the necessary circuits.
- ⚠️ ROOMTEC LED mirror adopts three-pin plug and power leads must be connected to ground wire.
- ⚠️ **DO NOT** put hard and sharp materials directly against the mirror surface during operation, otherwise it may result in current leakage and even personal injury accident.
- ⚠️ **Never** forget to turn off the power supply in stormy days, otherwise electric components of the product could be damaged.
- ⚠️ **DO NOT** switch off the power supply directly during normal operation, otherwise electric elements of the product may be easily damaged.
- ⚠️ Please turn off the power supply if the product is not used for a long time.
- ⚠️ **DO NOT** remove protective film or corner protectors until the mirror is completely installed.
- ⚠️ **PLEASE KEEP THIS MANUAL BOOK FOR FUTURE REFERENCE.**



# LED Wall-Mounted Mirror

## LED Mirror Physical Picture



LED Rectangle Bathroom Mirror

LED Human Body Induction Mirror



LED Rectangle Aluminum Framed Mirror

LED Rectangle & Round Mirror



# LED Wall-Mounted Mirror

---

## Wiring

ROOMTEC supplies an about 5ft long power cable and U.S 3-pin plug for easy connection with a wall socket. Optional to cut the plug directly and connect to electrical wiring if using the wall switch.

## Cleaning

When the mirror has to be cleaned, please switch off the power first.  
 DO NOT use abrasives or solvents when cleaning.  
 DO NOT let water get in the mirror and submerge mirror in water.  
 Wipe off all water spillages as soon as possible via a soft, damp cloth.

## Specification

Product Name:	LED LIGHTED MIRROR	Certificates:	ETL, CE, ROHS
LED Qty:	240/m	Input Voltage:	110V
Design Style:	Modern	Power:	As specified on product label
Feature:	Illuminated	Lumen:	2000-5000 LM
Mirror Shape:	Rectangle	Input Frequency:	60Hz
Function:	Anti-fog, memory function	Color Temperature:	3000K-6000K
Installation:	Wall mounted	IP Rating:	IP44
Glass Thickness:	5mm	Dimming Function:	Yes
Light Color:	Warm/White/Warm white changeable	Hanging Way:	Horizontal and/or Vertical
Touch Sensor:	Yes	Connection Way:	Plug-in or Hardwired
Material:	Copper-free silvered glass + Aluminum frame	Application:	Bathroom, makeup room



# LED Wall-Mounted Mirror

## Operation Instructions ---3000K-6000K

Memory Function---the mirror will remember the light color and brightness when it was last turned off.

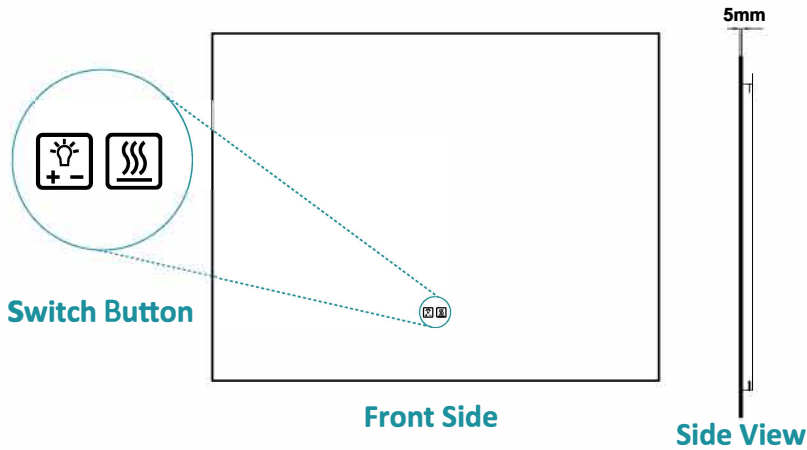

### Light on/off

Power on, then press to turn the light on, the light is white light.

Then second time press , the light change to warm light.

The third time press , the light change to warm white light .

Then press again to turn the light off.

Press and hold for 3 seconds, and the blue indicator light of the mirror will turn off.

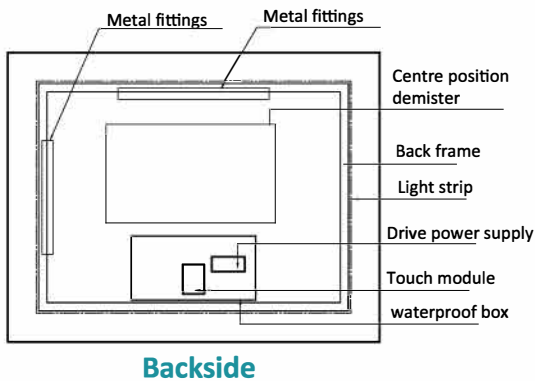

### Dimming instruction

Power on, press to turn the light on, then press and hold , the brightness will change accordingly.

### Fog-free instruction

**( Safe Defogging---Automatically shut off after one hour.)**

Power on, press , the mirror can be defogging.

## Installation

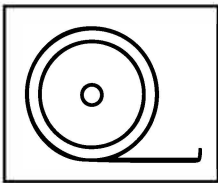

Ruler

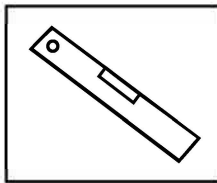

Spirit Level

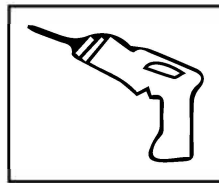

Electrical Drill

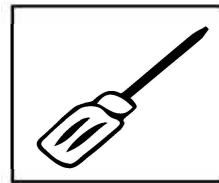

Screwdriver

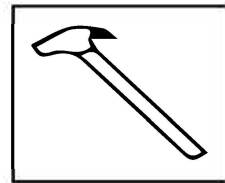

Hammer

## Parts List

1X	2X	2X	4X

**NOTE:**  
It's more stable to pad this on the back of the aluminum frame of the mirror.

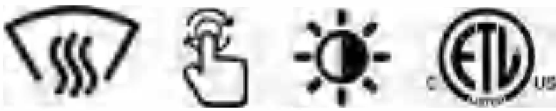

# LED Wall-Mounted Mirror

---

## Operation Instructions --- LED Human Body Induction Mirror

### Function Description

**1. Power on and enter the state of the last shutdown or power outage. (Power outage with memory)**

**2. Lighting switch controller.**

2.1 Short press for color changing, white color → warm color → natural color.

2.2 Long press for dimming, 4.5% - 100%.

**3. Fog-free switch controller.**

3.1 Short press to on/off fog-free function.

3.2 Fog-free timing function: Turn on for 1 hour and automatically turn off.

**4. Human body detection switch controller.**

4.1 The off-light state has a human body detection function, which automatically lights up when the human body is detected; No detection function when the lights are on.

4.2 When the defogging function is turned off, press and hold the defogging button for 2 seconds, and the blue light flashes twice to turn off the human body detection function; The white light flashes twice to activate the human body detection function.

**5. Off-screen function: Press and hold for 3 seconds when the lighting is turned off to turn off the backlight. The human body detection function fails when the screen is turned off. Sense Distance:16"- 47" (400-1200mm).**



# LED Wall-Mounted Mirror

## Step 1

Measure the distance between two holes on the aluminum strip.

**NOTE:** Please be sure to remove the corner guards after installation to avoid damaging the corners of the mirror during installation.

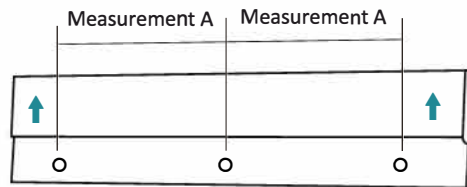

## Step 2

According to the distance from A, choose a suitable height and punch holes in the wall.

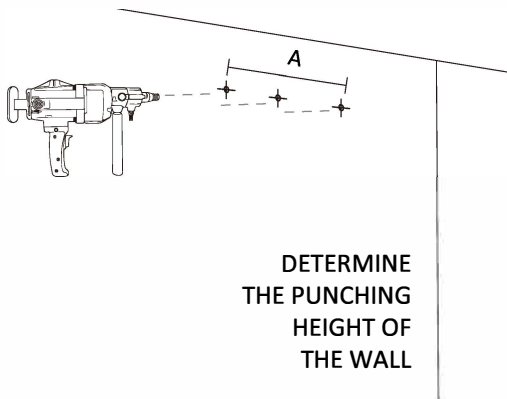

## Step 3

Drive the expansion plug into the hole on the wall and then put the screw into the expansion plug to fix the aluminum strip on the wall.

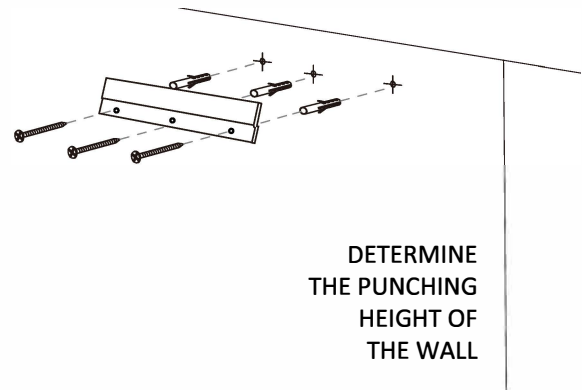

## Step 4

Hang the mirror on the wall.

**NOTE:** Mirrors with a width of 48 inches or more can only be hung horizontally, not vertically.

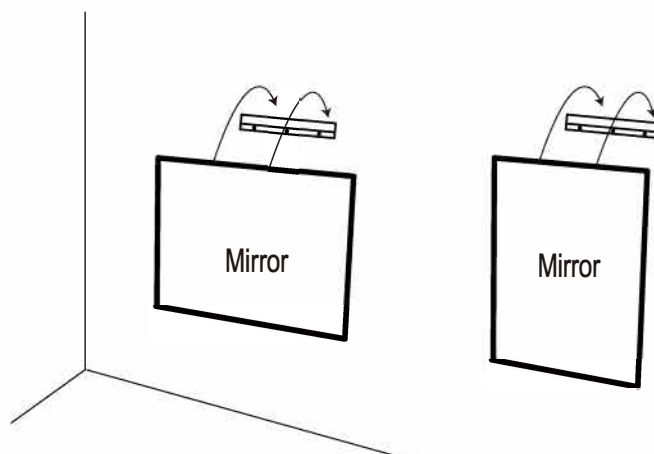



# LED Wall-Mounted Mirror

## ★★★ About the wire connection ★★★

There are two ways to connect the circuit for the mirror.

**Connection way ①:** Plug the 3-pin plug in the socket on the wall.

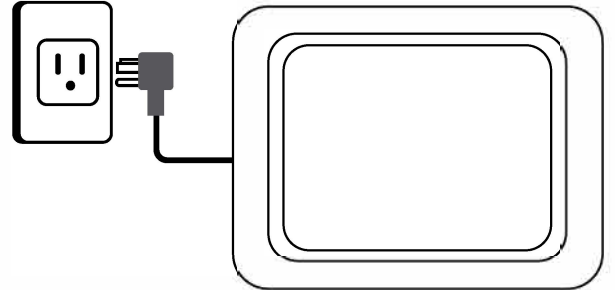

**Connection way ②:** Cut of the plug, and connect the mirror's wire to the wall switch's wire.  
(Recommend installation by professional electrician)

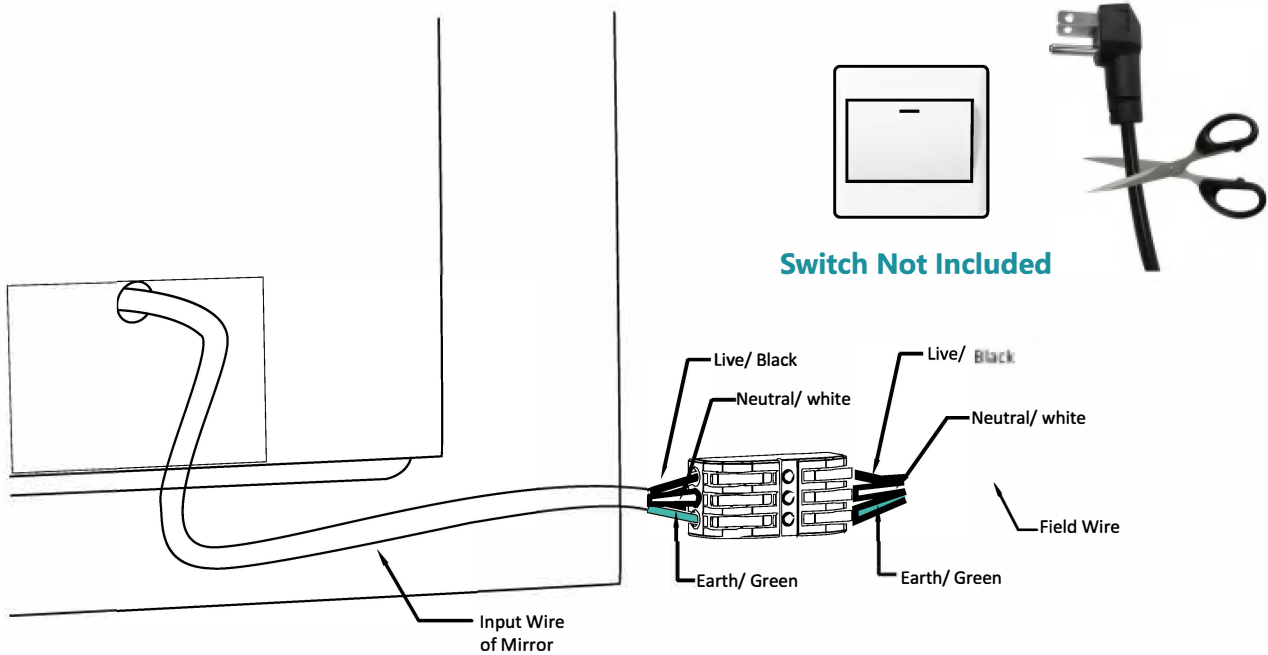

# AFTER-SALES SERVICE CARD

We sincerely thank you for trusting our service and our products, and may this product add enrichment to your home. We guarantee that the product has undergone strict quality inspection and meticulous packaging. If you encounter any issue regarding either shipping or the product, please feel free to contact us at any time. We'd be more than happy to serve you wholeheartedly.

Yours Sincerely

- Please clean with a damp cloth and wipe dry.
- Please avoid harsh, corrosive and abrasive cleaners.
- Keep dry and avoid damp environments.

---

If you have any questions or concerns, please feel free to contact us. We're committed to providing our customers with the quality service.