



USER'S MANUAL
Dining Set

Contact Us!

Do NOT return this item.

Contact our friendly customer service department for help first.







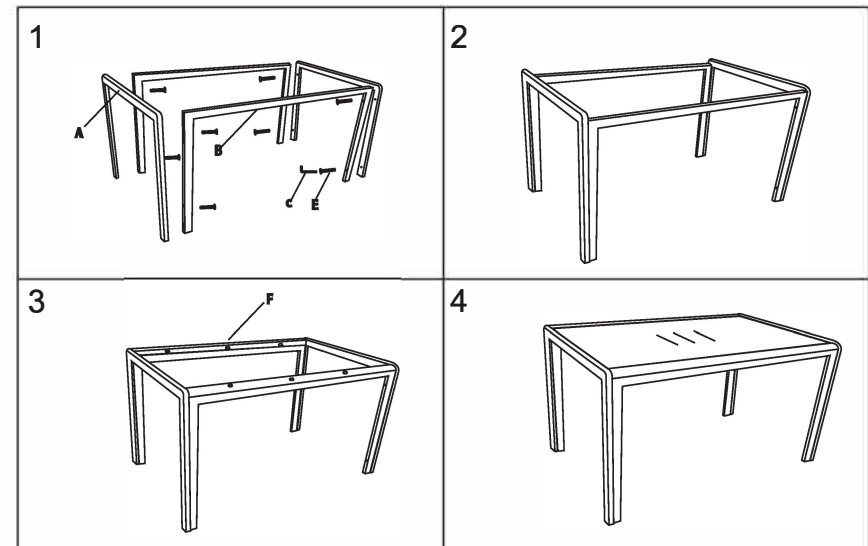
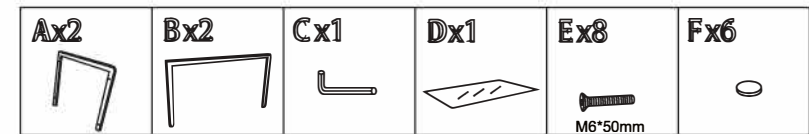
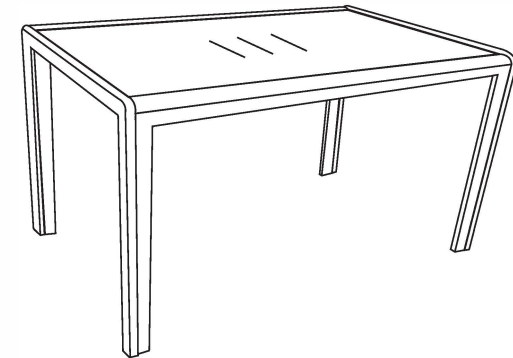



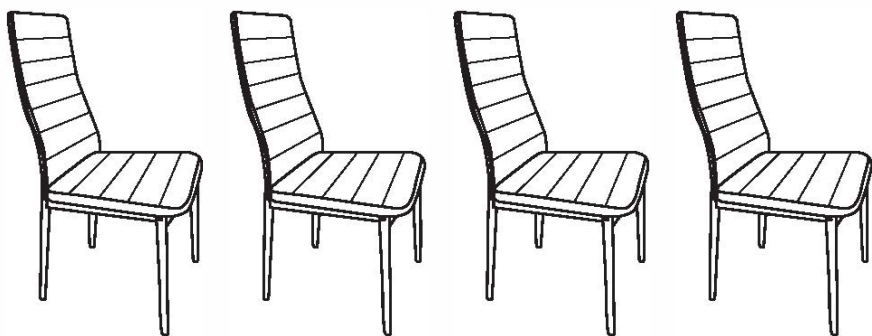

Before You Start

- ⦿ Please read all instructions carefully.
- ⦿ Retain instructions for future reference.
- ⦿ Separate and count all parts and hardware.
- ⦿ Read through each step carefully and follow the proper order.
- ⦿ We recommend that, where possible, all items are assembled near to the area in which they will be placed in use, to avoid moving the product unnecessarily once assembled.
- ⦿ Always place the product on a flat, steady and stable surface.
- ⦿ Keep all small parts and packaging materials for this product away from babies and children as they potentially pose a serious choking hazard.



Please do not tighten the bolts(E) until step 3.



A x 4 	B x 4 	C-L x 4 	C-R x 4 	D x 4 	E x 8  M6x45mm
F x 16  M6x15mm	G x 16  M4x45mm	H x 1 			

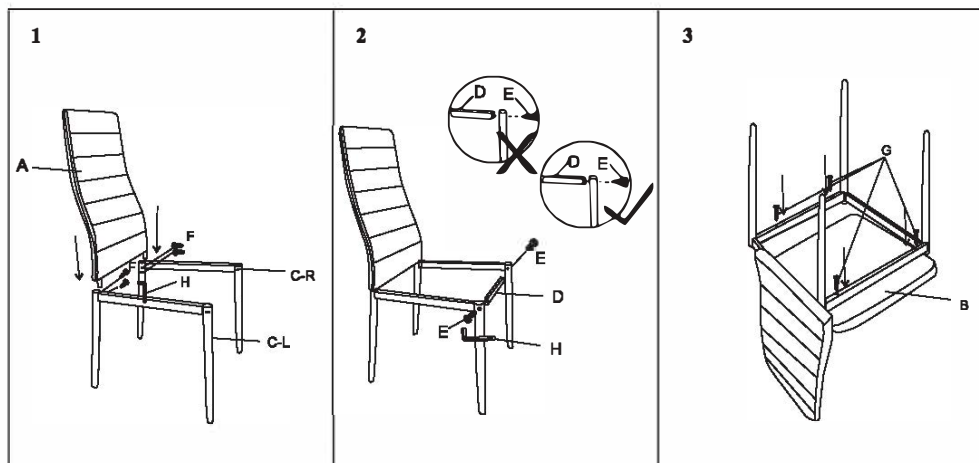

Please do not tighten the bolts(F) until step 3.