



INSTRUCTIONS D'ASSEMBLAGE
ASSEMBLY INSTRUCTIONS

ETAGERE -
72"H / METAL ARGENT ET VERRE TREMPE





BOOKCASE -
72"H / SILVER METAL WITH TEMPERED GLASS







**POUR DE L'ASSISTANCE OU POUR COMMANDER
DES PIÈCES CONTACTEZ NOTRE DÉPARTEMENT
DE SERVICE À LA CLIENTÈLE.**

**FOR ASSISTANCE OR TO ORDER PARTS
CONTACT OUR CUSTOMER SERVICE DEPARTMENT**

LISTE DES PIÈCES
PARTS LIST

PIÈCE / PART #	IMAGE	DESCRIPTION	QTY / QTÉ
1		METAL LEG PATTE EN METAL	2
2		METAL LEG PATTE EN METAL	2
3		METAL LEG PATTE EN METAL	2
4		METAL LEG PATTE EN METAL	2
5		TOP FRAME CADRE DE SURFACE	1

LISTE DES PIÈCES
PARTS LIST

PIÈCE / PART #	IMAGE	DESCRIPTION	QTY / QTÉ
6		METAL FRAME CADRE EN MÉTAL	1
7		METAL FRAME CADRE EN MÉTAL	1
8		METAL FRAME CADRE EN MÉTAL	2
9		METAL FRAME CADRE EN MÉTAL	1
10		METAL FRAME CADRE EN MÉTAL	1



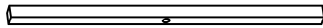

LISTE DES PIÈCES

PARTS LIST

PIÈCE / PART #	IMAGE	DESCRIPTION	QTY / QTÉ
11		METAL FRAME CADRE EN MÉTAL	1
12		METAL FRAME CADRE EN MÉTAL	1
13		BOTTOM FRAME CADRE DU BAS	1
14		SUPPORT BAR BARRE DE SOUTIEN	2
15		SUPPORT BAR BARRE DE SOUTIEN	4

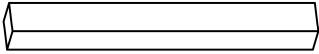
LISTE DES PIÈCES

PARTS LIST

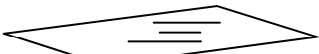
PIÈCE / PART #	IMAGE	DESCRIPTION	QTY / QTÉ
16		SUPPORT BAR BARRE DE SOUTIEN	2
17		GLASS TOP SURFACE EN VERRE	1
18		GLASS SHELF ÉTAGÈRE EN VERRE	1
19		GLASS SHELF ÉTAGÈRE EN VERRE	3
20		GLASS SHELF ÉTAGÈRE EN VERRE	3

LISTE DES PIÈCES
PARTS LIST

PIÈCE / PART #	IMAGE	DESCRIPTION	QTY / QTÉ
21		GLASS SHELF ÉTAGÈRE EN VERRE	2

LISTE DES PIÈCES DE MONTAGE HARDWARE LIST

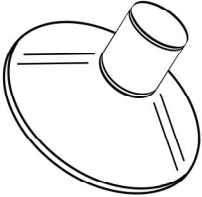
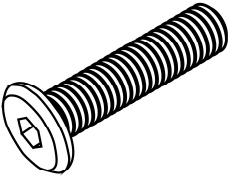
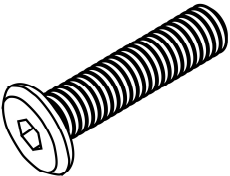
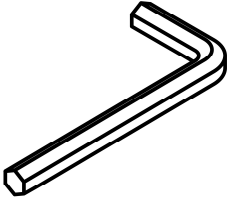
PIÈCE / PART #	IMAGE	DESCRIPTION	QTY / QTÉ
A		SUCTION CUP - Ø 3/4" VENTOUSE - Ø 3/4"	40
B		ASSEMBLING BOLT - Ø 1/4" X 1/2" BOULON D'ASSEMBLAGE - Ø 1/4" X 1/2"	4
C		ASSEMBLING BOLT - Ø 1/4" X 1 3/8" BOULON D'ASSEMBLAGE - Ø 1/4" X 1 3/8"	46
D		HEX KEY CLÉ HEXAGONALE	1

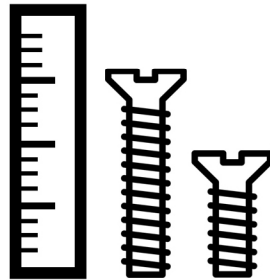

**OUTIL DE VÉRIFICATION DE DIMENSIONS DES PIÈCES
HARDWARE DIMENSIONS VERIFICATION TOOL**

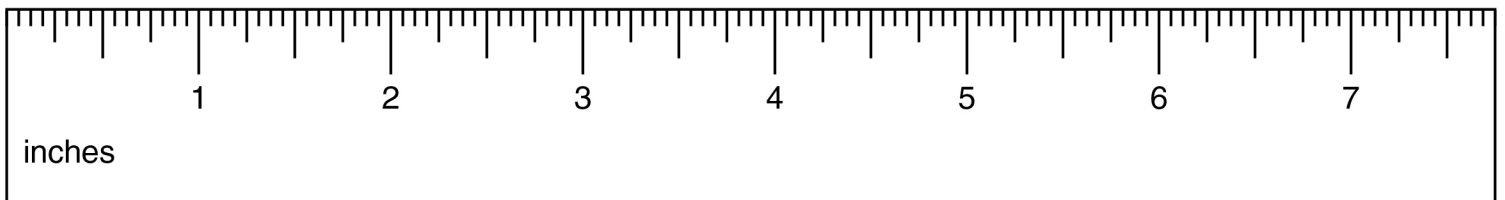

ÉTAPE / STEP 1

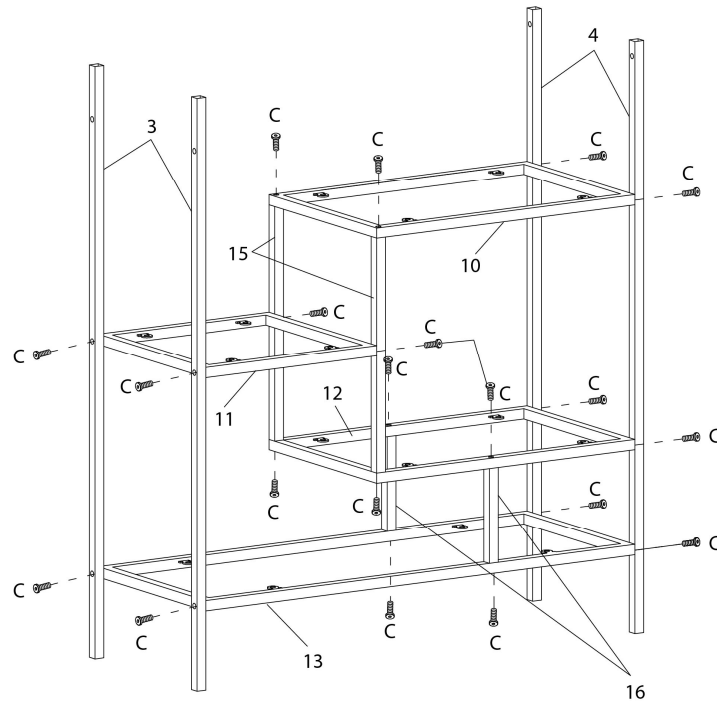

ÉTAPE / STEP 2

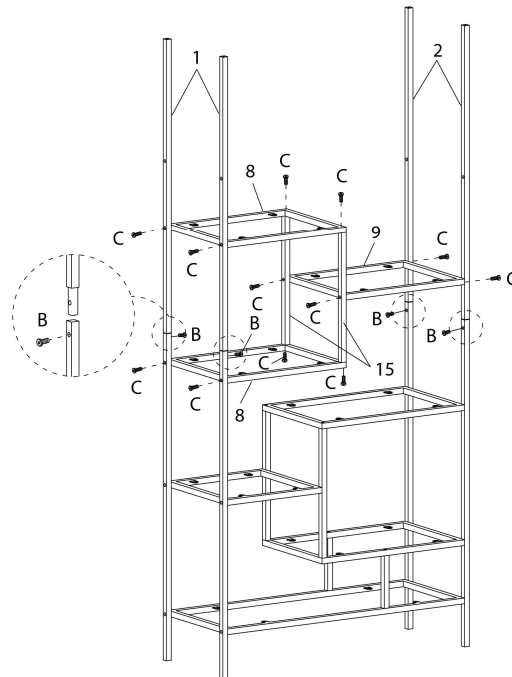

ÉTAPE / STEP 3

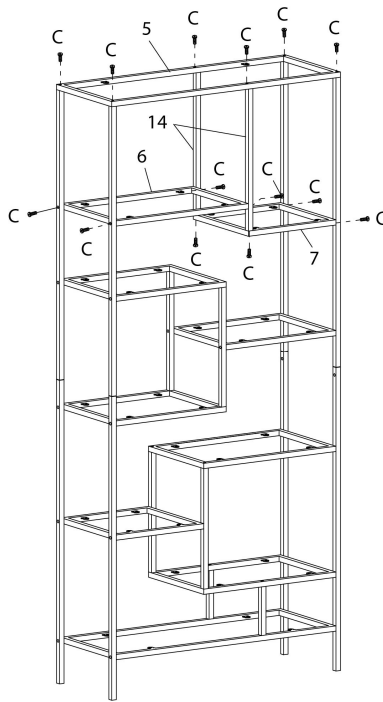

ÉTAPE / STEP 4

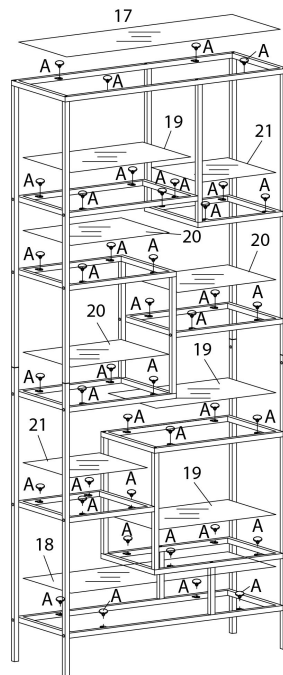

ÉTAPE / STEP 5

