

INSTRUCTION MANUAL

TOOLS REQUIRED

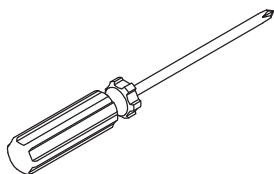

Phillips Screwdriver

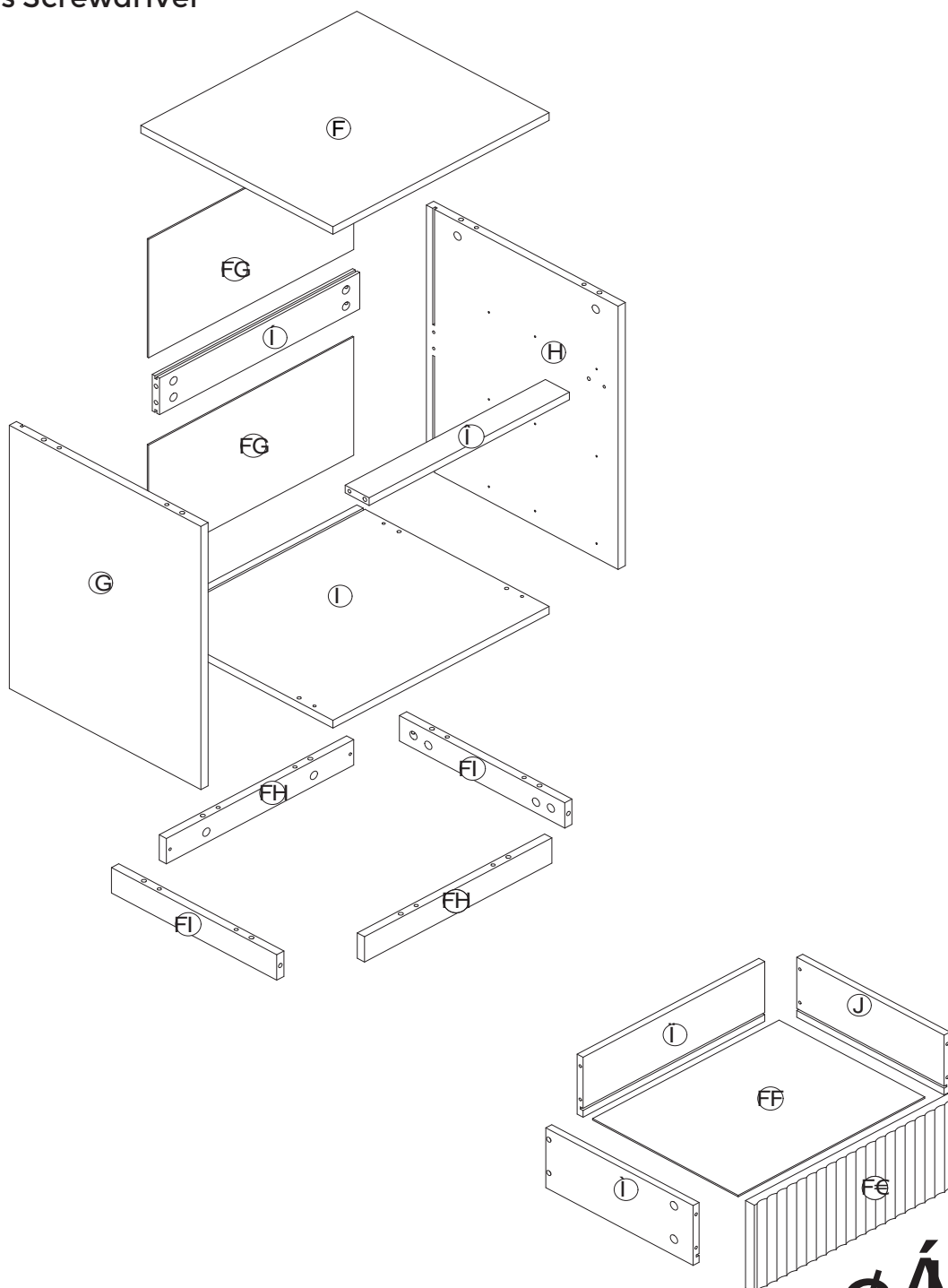

CAH

☰ PARTS LIST

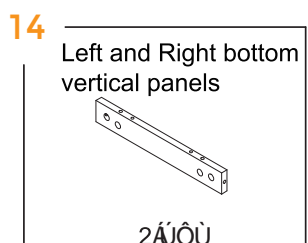
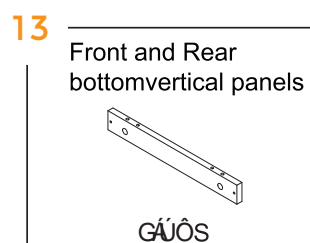
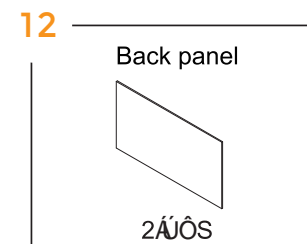
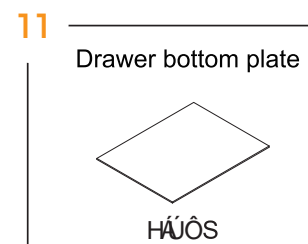
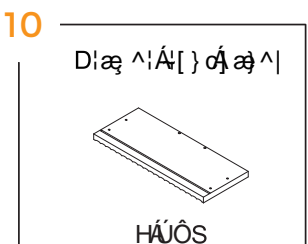
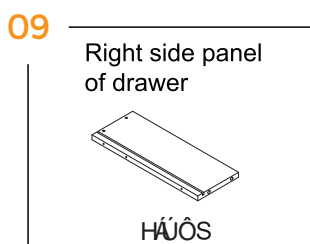
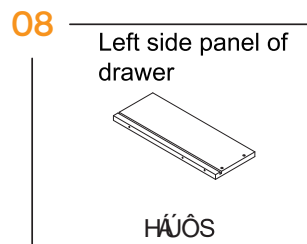
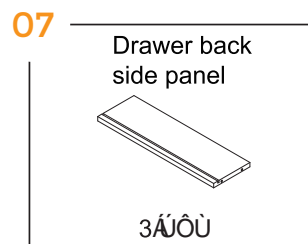
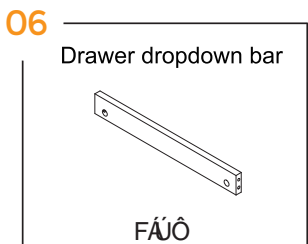
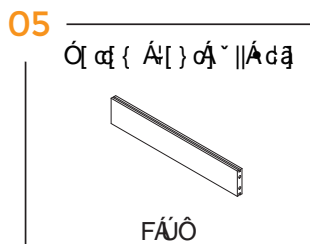
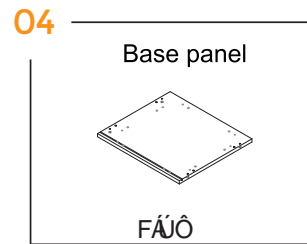
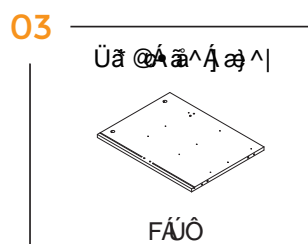
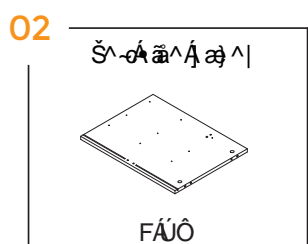
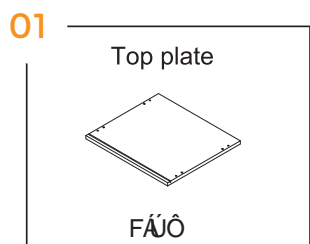

☰ HARDWARE LIST

A

TÍ CHÍ { {
Óæ ÁÓ |c



34ÉGÁJÒÙ

B

< FÍ cFÉI {
Óæ ÁÓ | &



34ÉGÁJÒÙ

C

< Ì cHEI {
Ó | , ^ |



18É2ÁJÒÙ

D

TÍ CHÍ { {
ÁJ&^,



16ÉFÁJÒÙ

E

T HFG {
ÁJ&^,



42ÉGÁJÒÙ

F

Recessed Handle

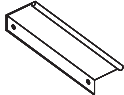

HÁJÒÙ

G

Óæ ÁÓ & | ^

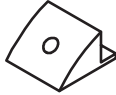

Î ÉFÁJÒÙ

H

ÁÁÁÁÁÁÁÁ | c^ |
Á^ • dæ á^ çæ^



FÁJÒÙ

I

T HFI { {
ÁÓæ ÁÓ & | ^ ÁJ&^,



Î ÉFÁJÒÙ

J

ÁÓ | cÁJæ



6ÉFÁJÒÙ

K

ÁJæ ^ |



FGÉFÁJÒÙ

DL

Ù | æ ä * Á | æ &



HÁJÒÙ

DR

Ù | æ ä * Á | æ &



HÁJÒÙ

CL

Ù | æ ä * Á | æ &

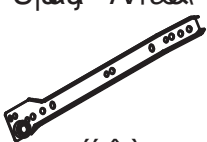

HÁJÒÙ

CR

Ù | æ ä * Á | æ &



HÁJÒÙ

! QÁ [~ Áæ ^ Á ã • ä * Áæ ^ Á æ • É | ^ æ ^ Á | [çæ ^ Á [~ | Á
[| á ^ | Á ~ { à ^ | Áæ á Áæ & ^ Á @ Á æ Á ~ { à ^ | È ^ } á Á • Áæ
] @ ç Á ~ Á @ Éæ á Á ^ Á ä | Á | [çæ ^ Á [~ Á ã @ Á Á
• æ ä æ ç | ^ Á [| ç | } ÉV @æ \ Á [~ È

ÛVÒÚÁĚ

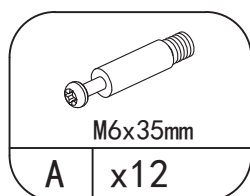
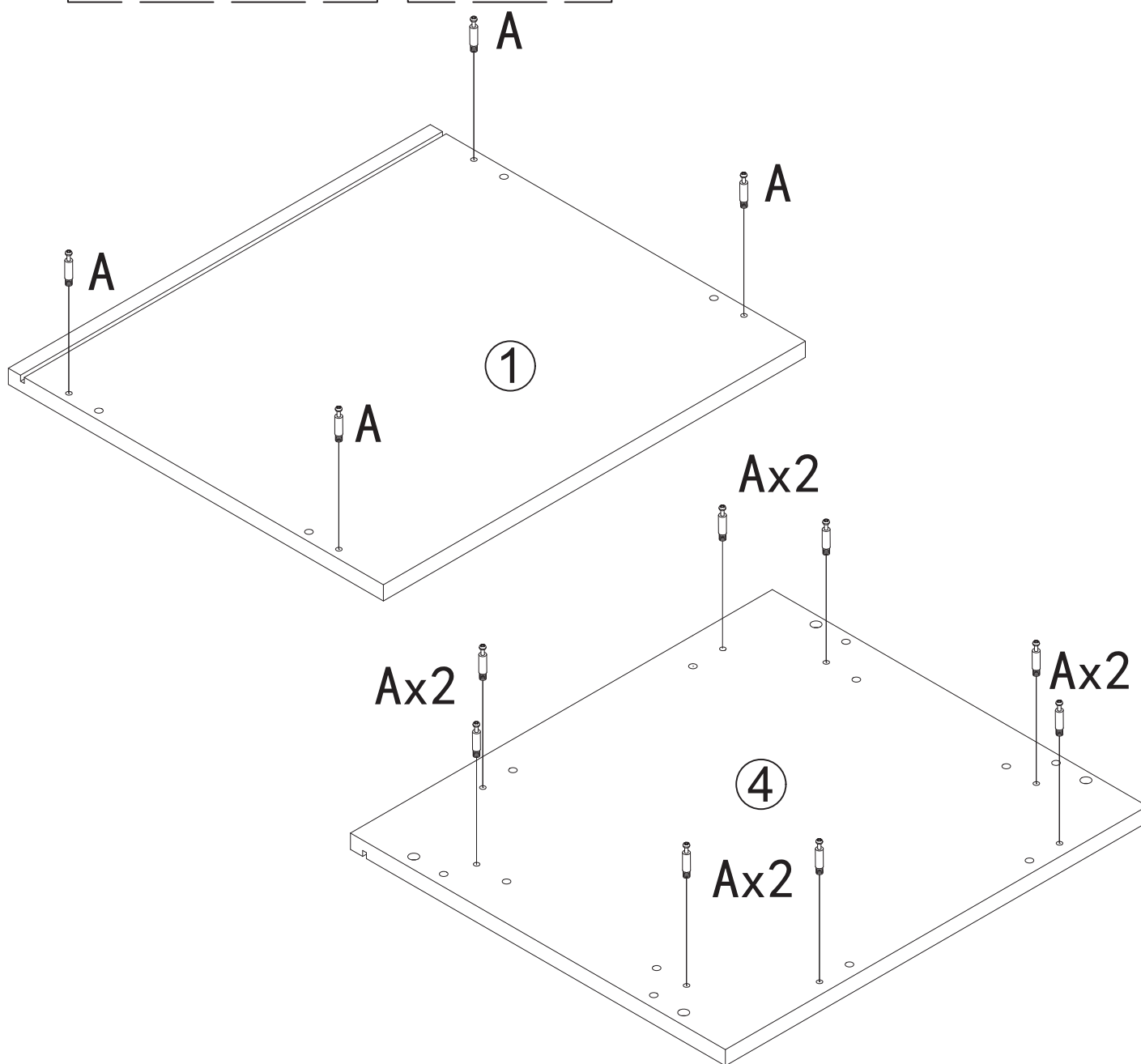
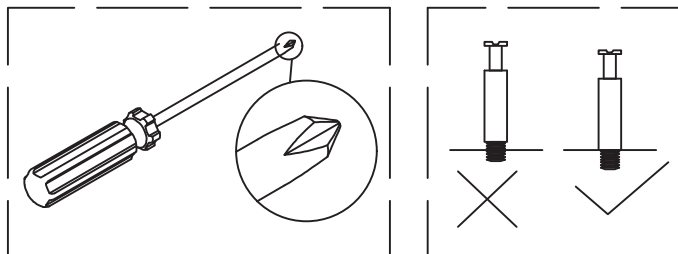

STEP 2

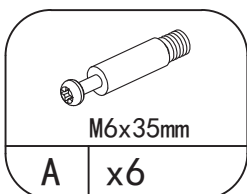
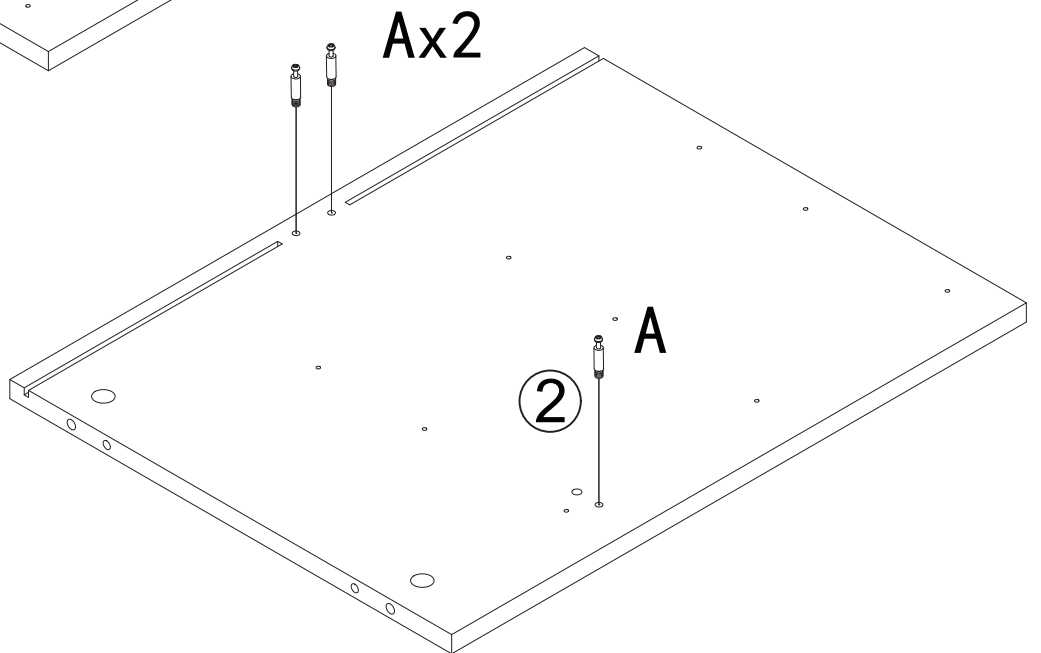
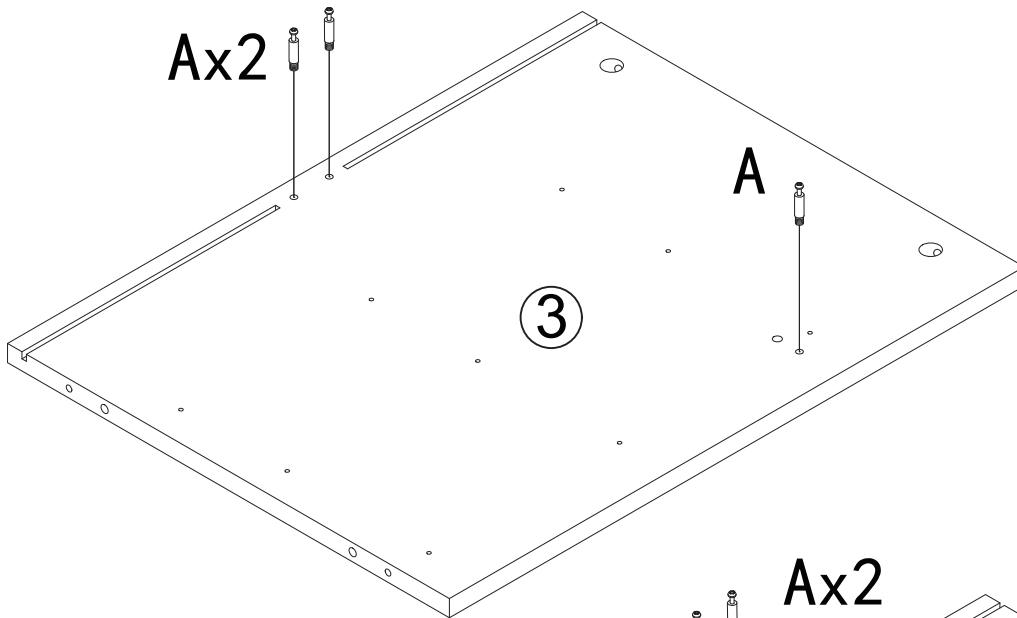
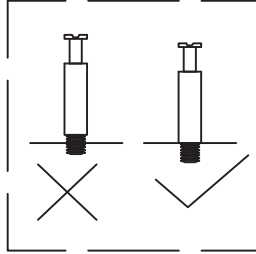
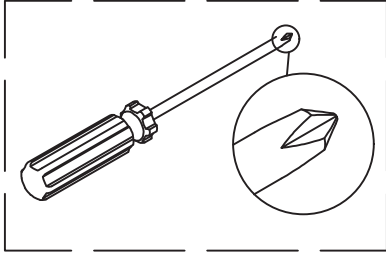

STEP 3

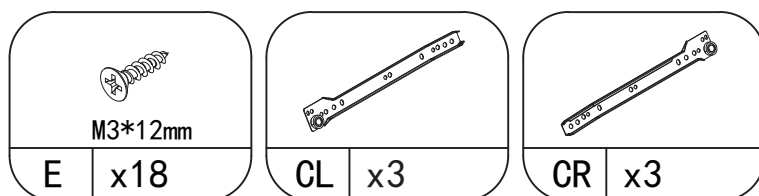
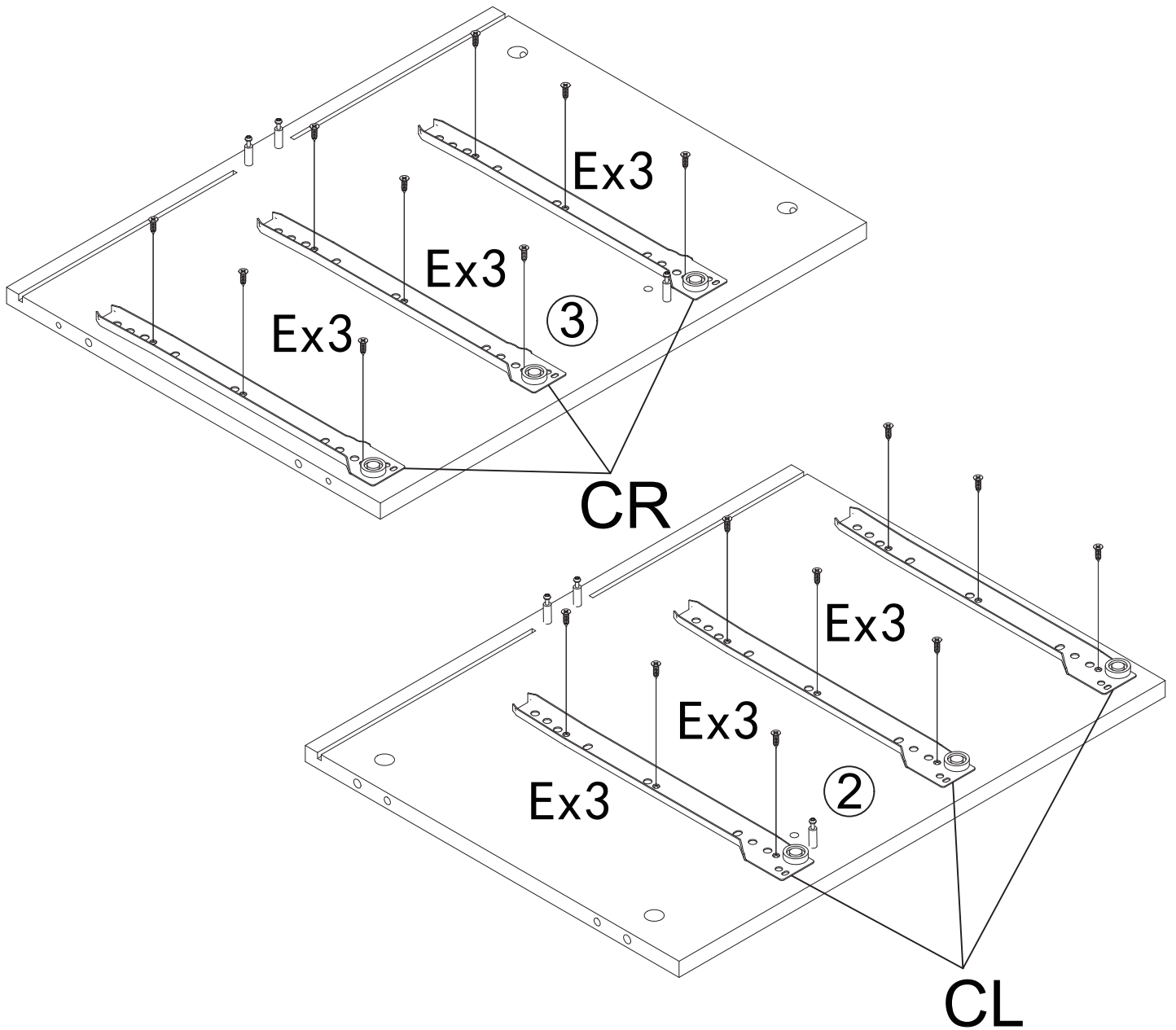
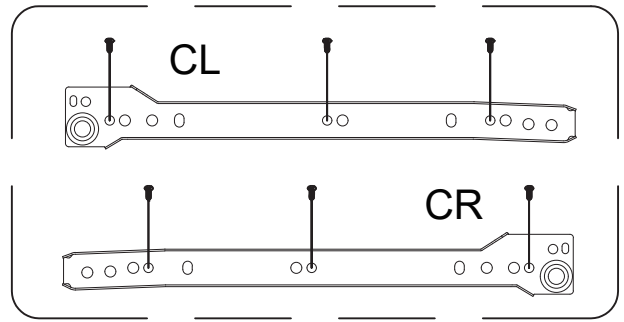

STEP 4

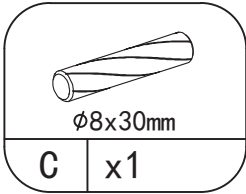
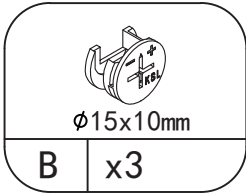
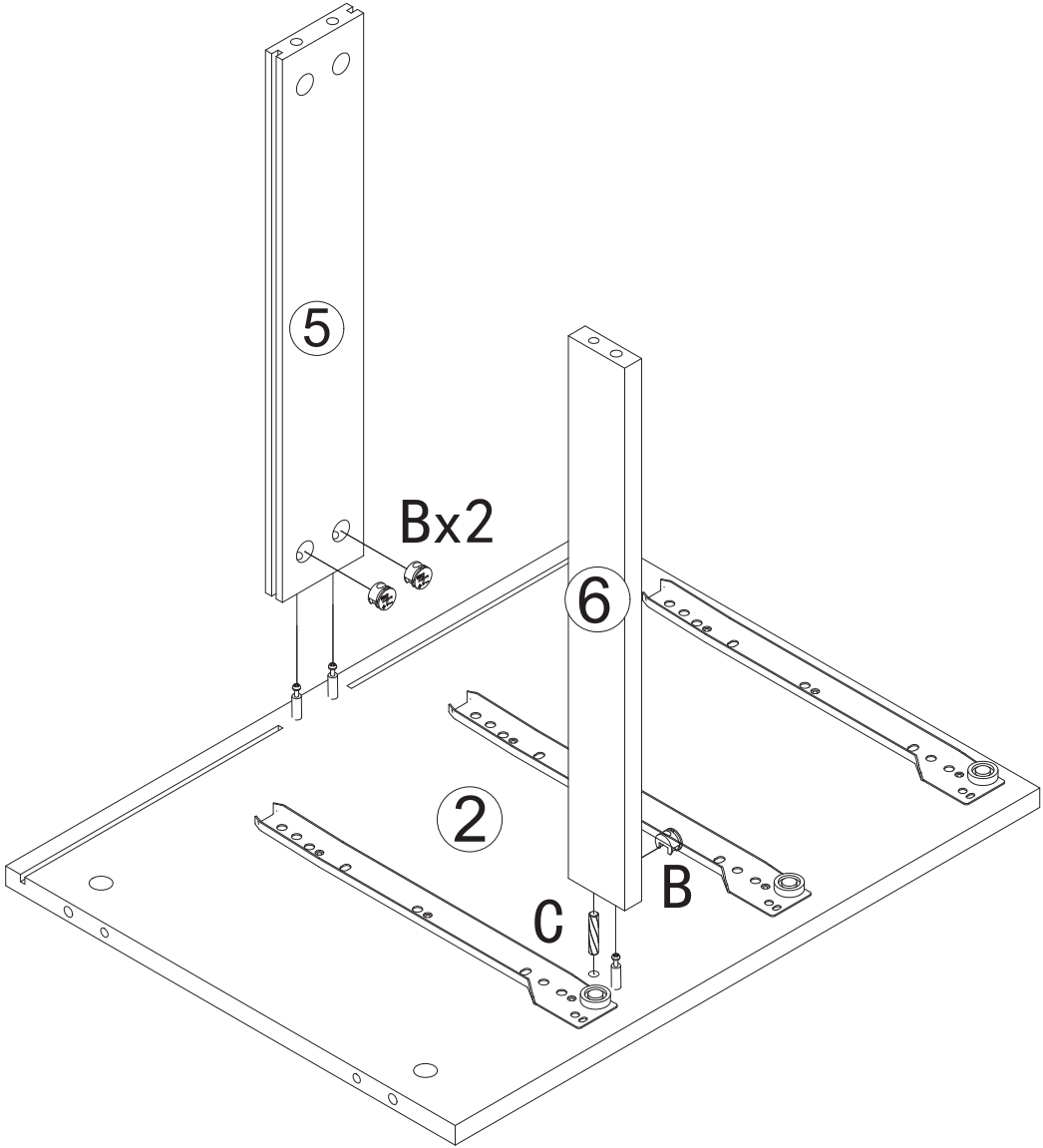
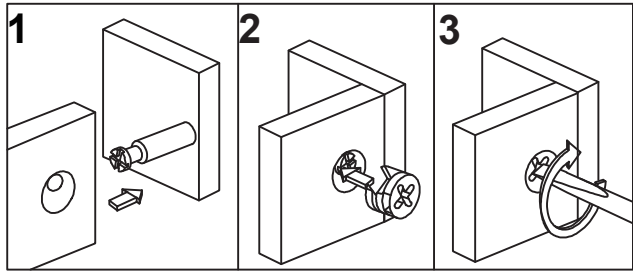

STEP 5

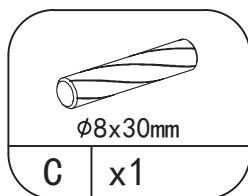
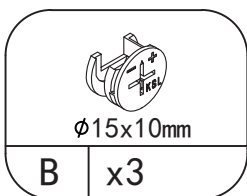
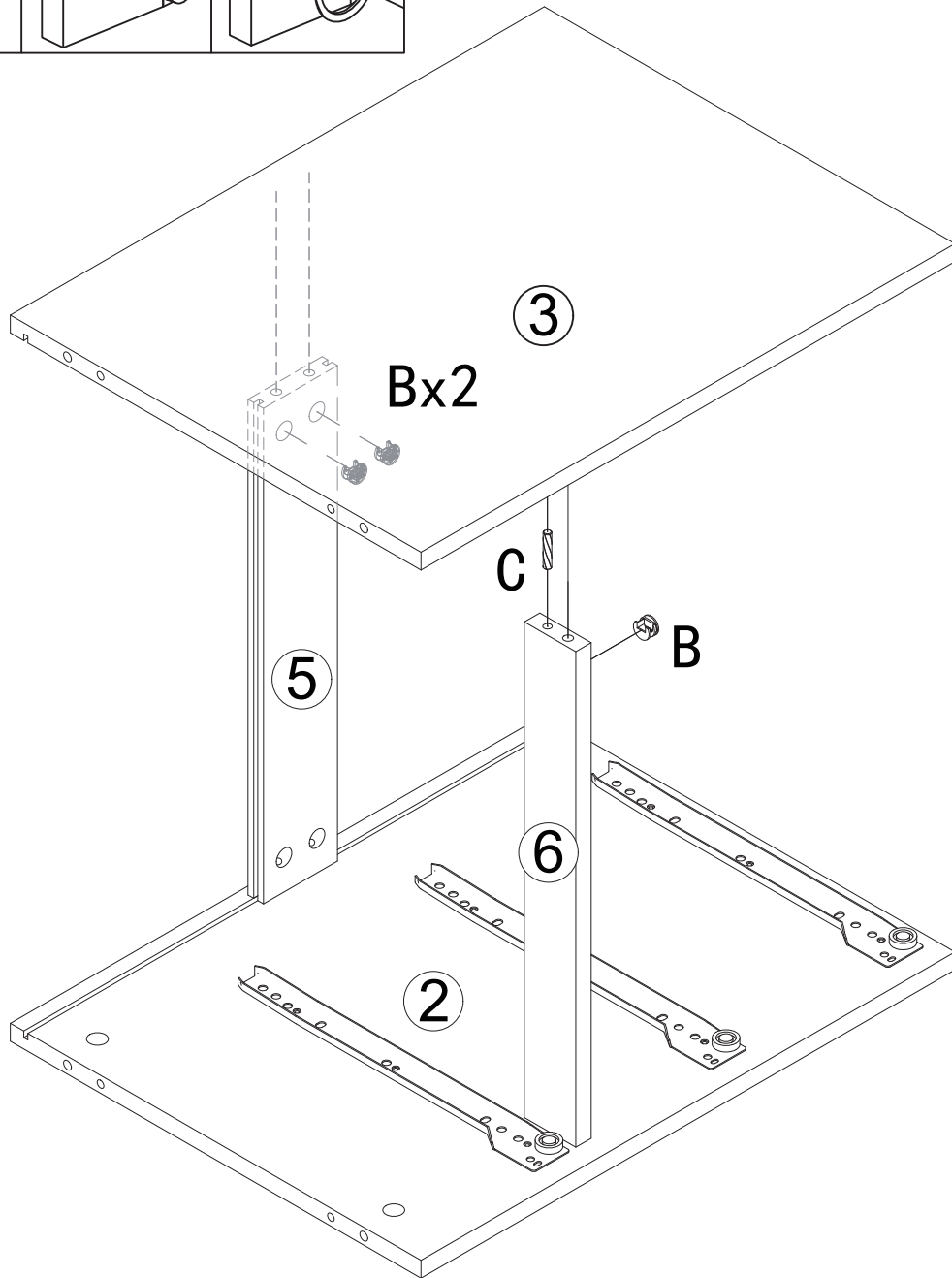
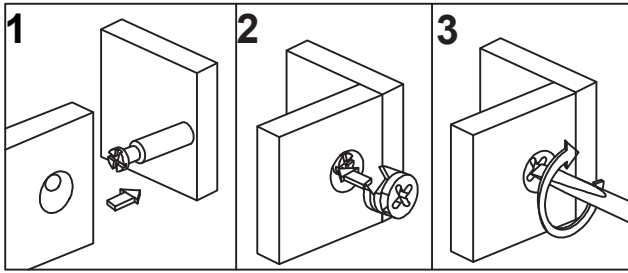

STEP 6

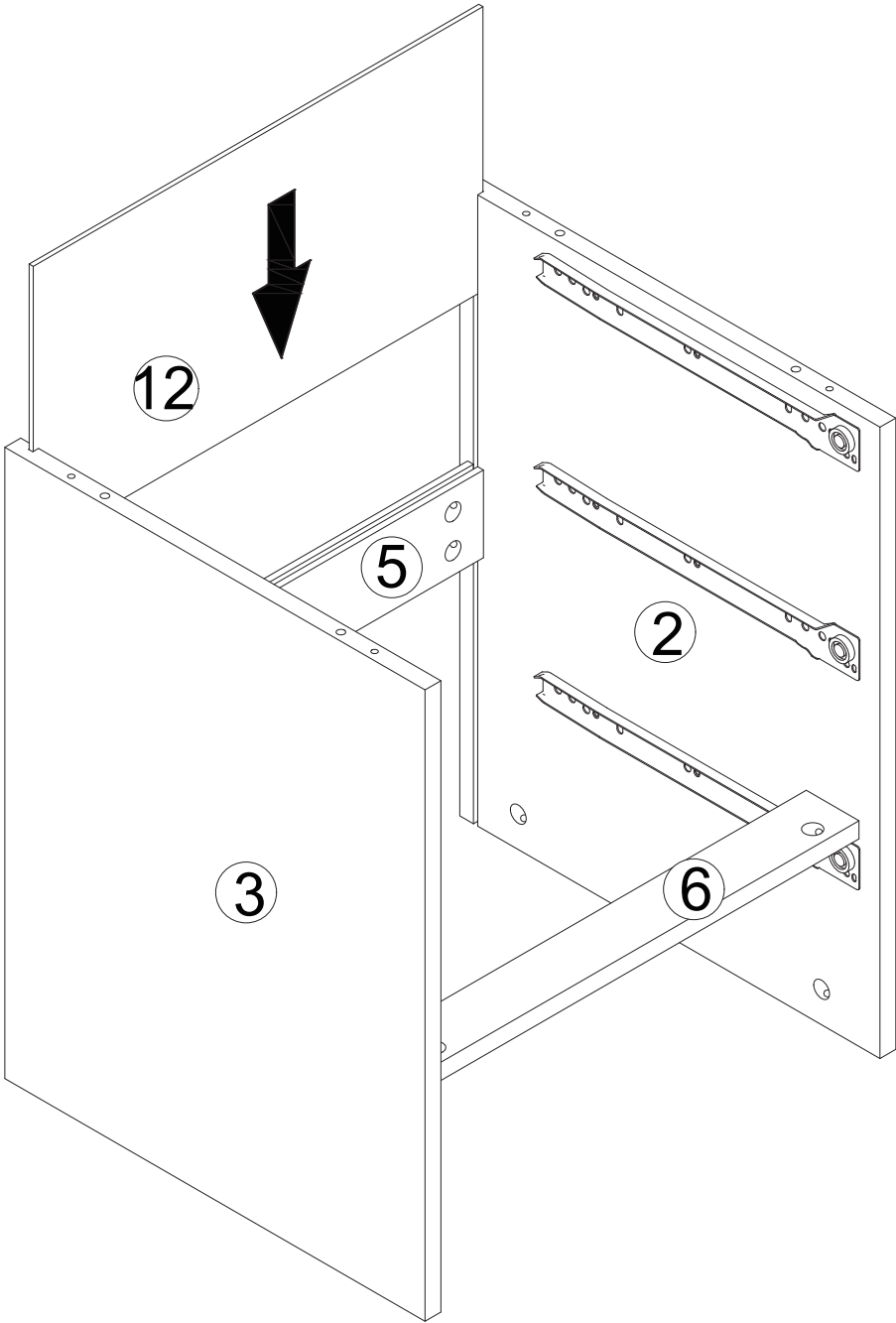

STEP 7

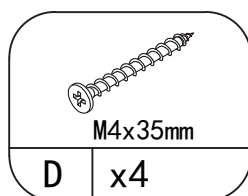
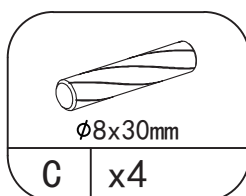
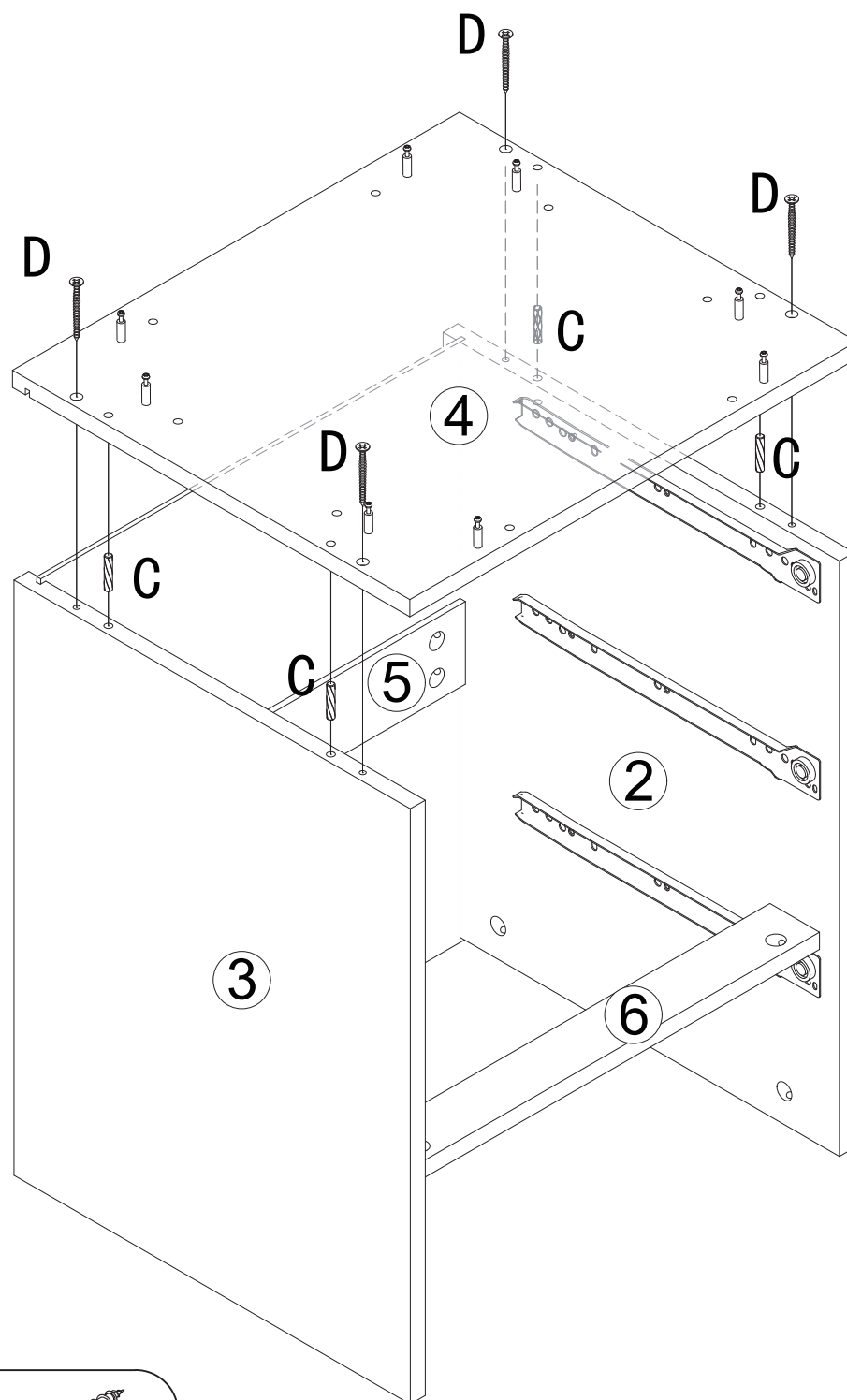

STEP 8

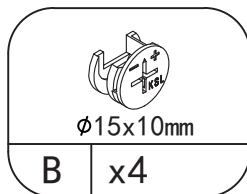
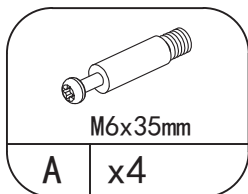
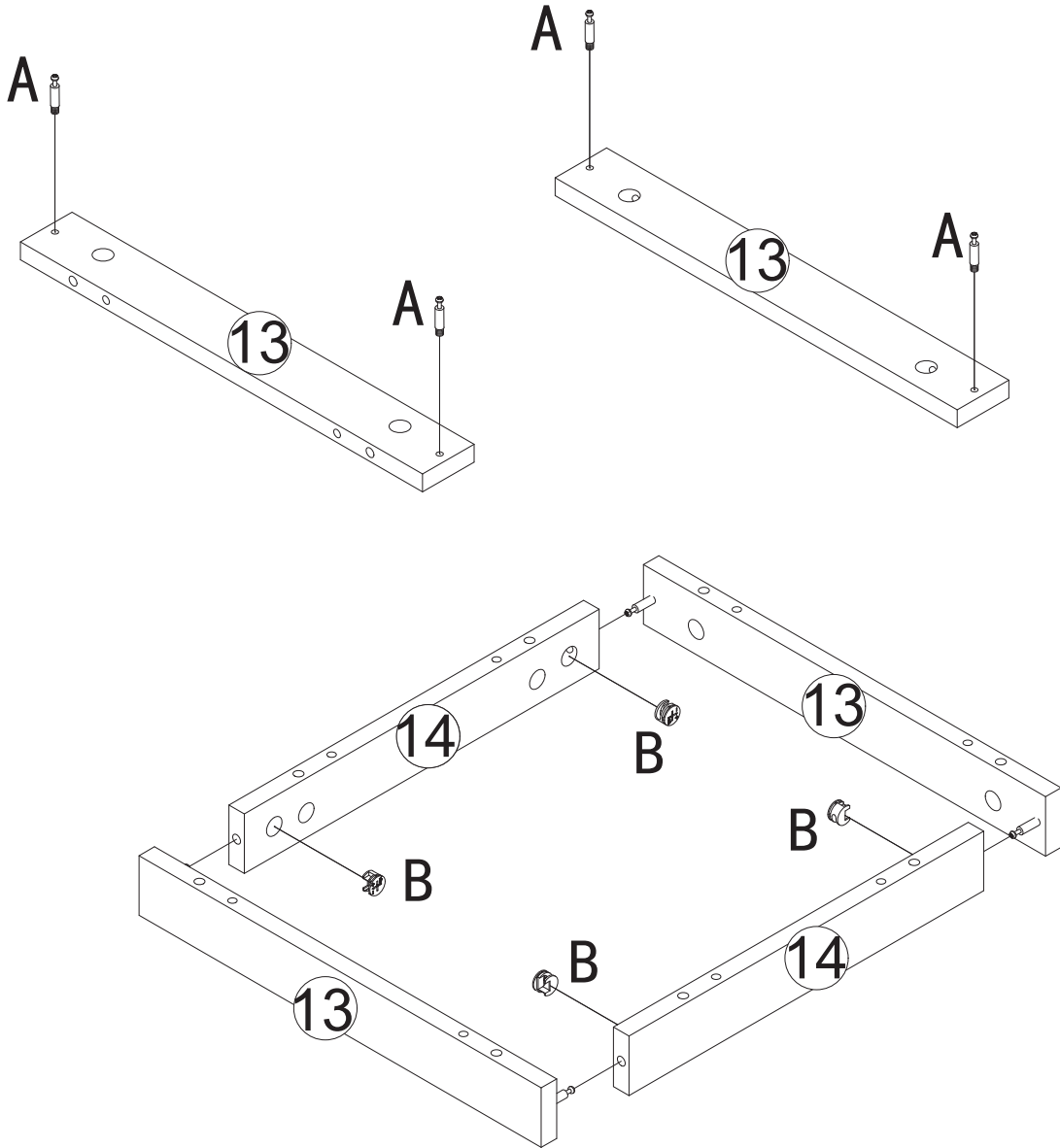
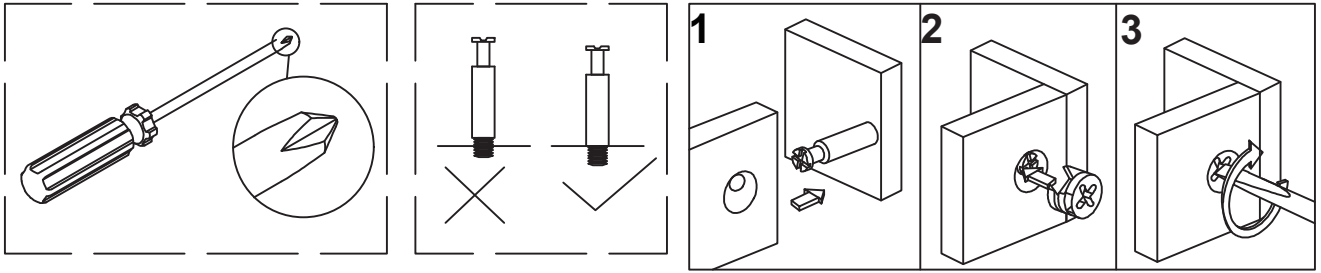

STEP 9

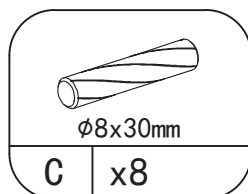
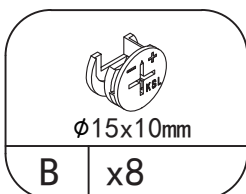
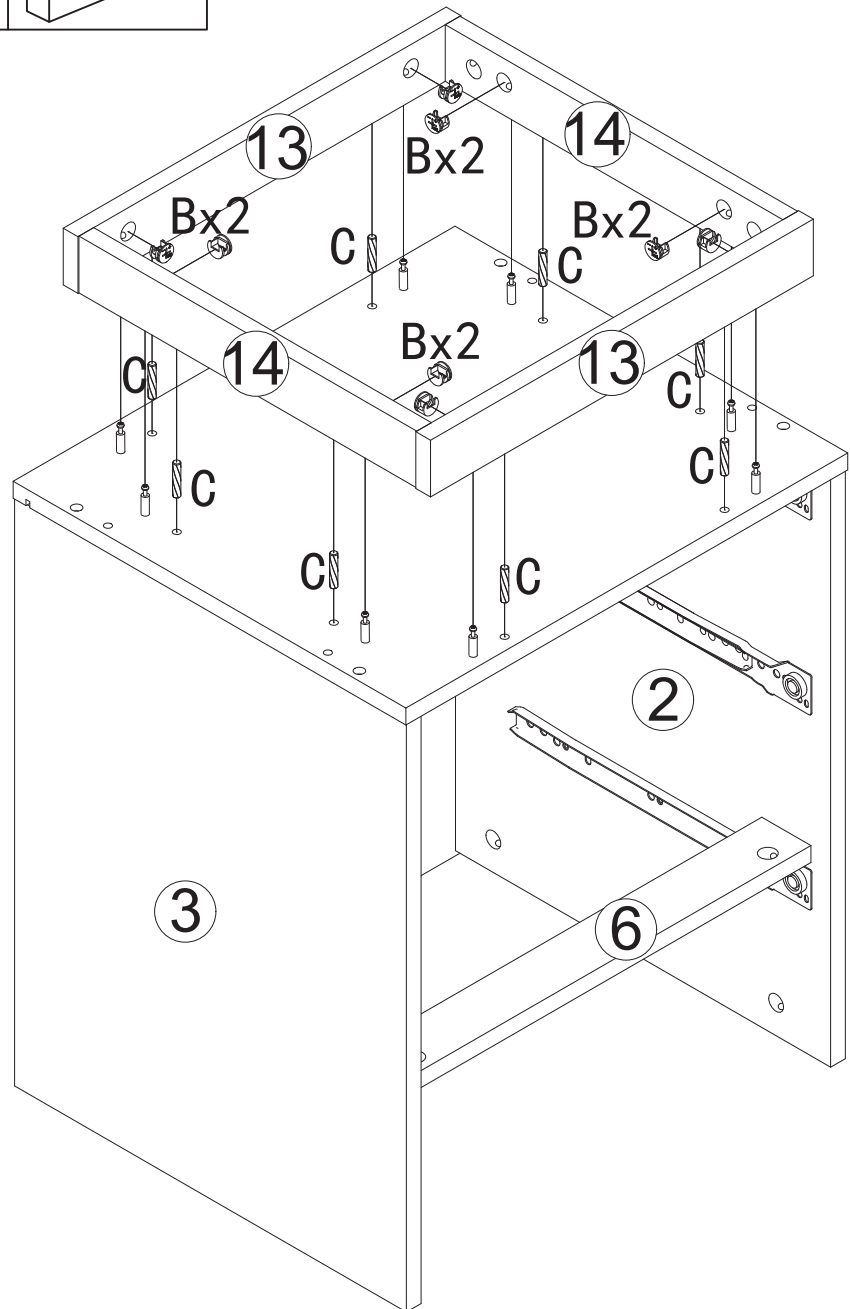
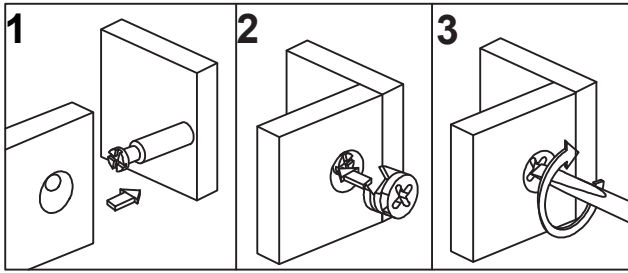

STEP 10

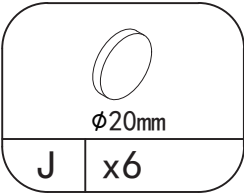
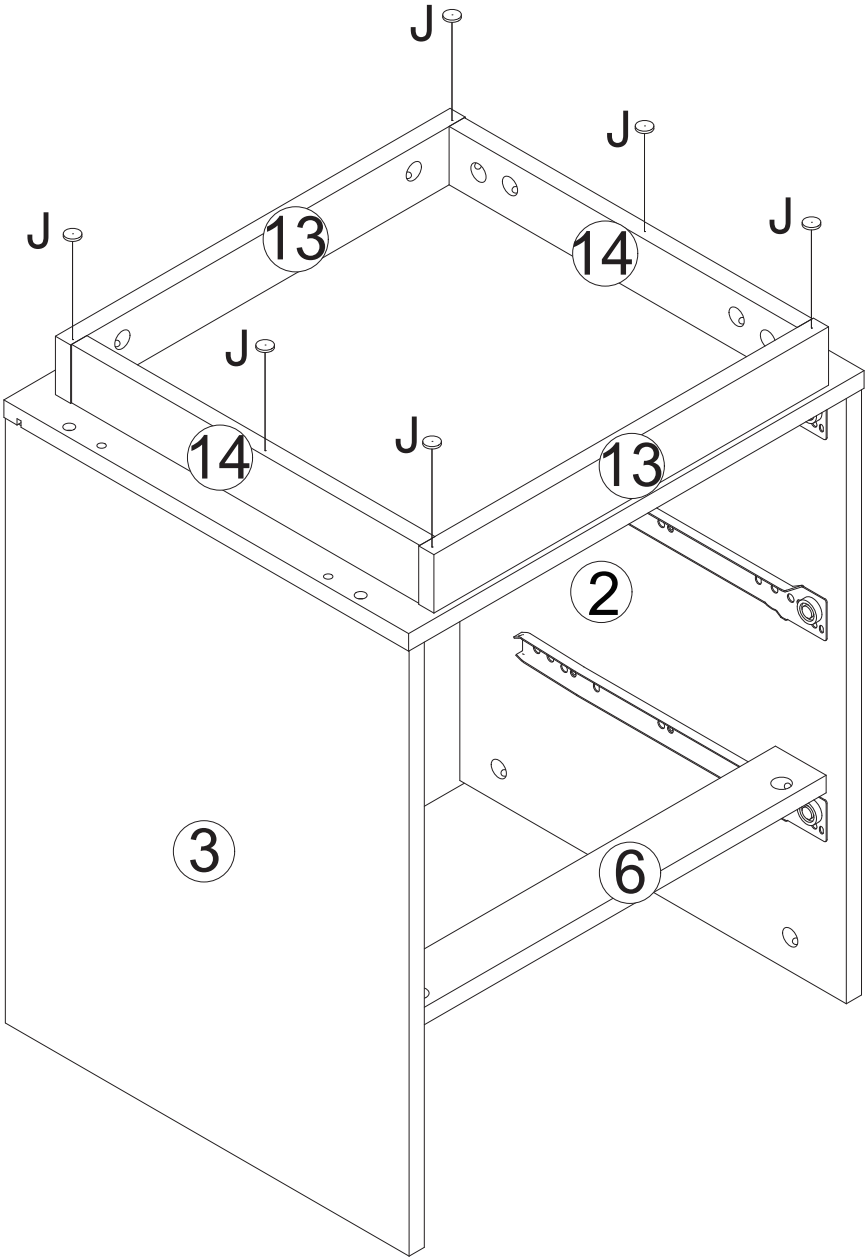

STEP 11

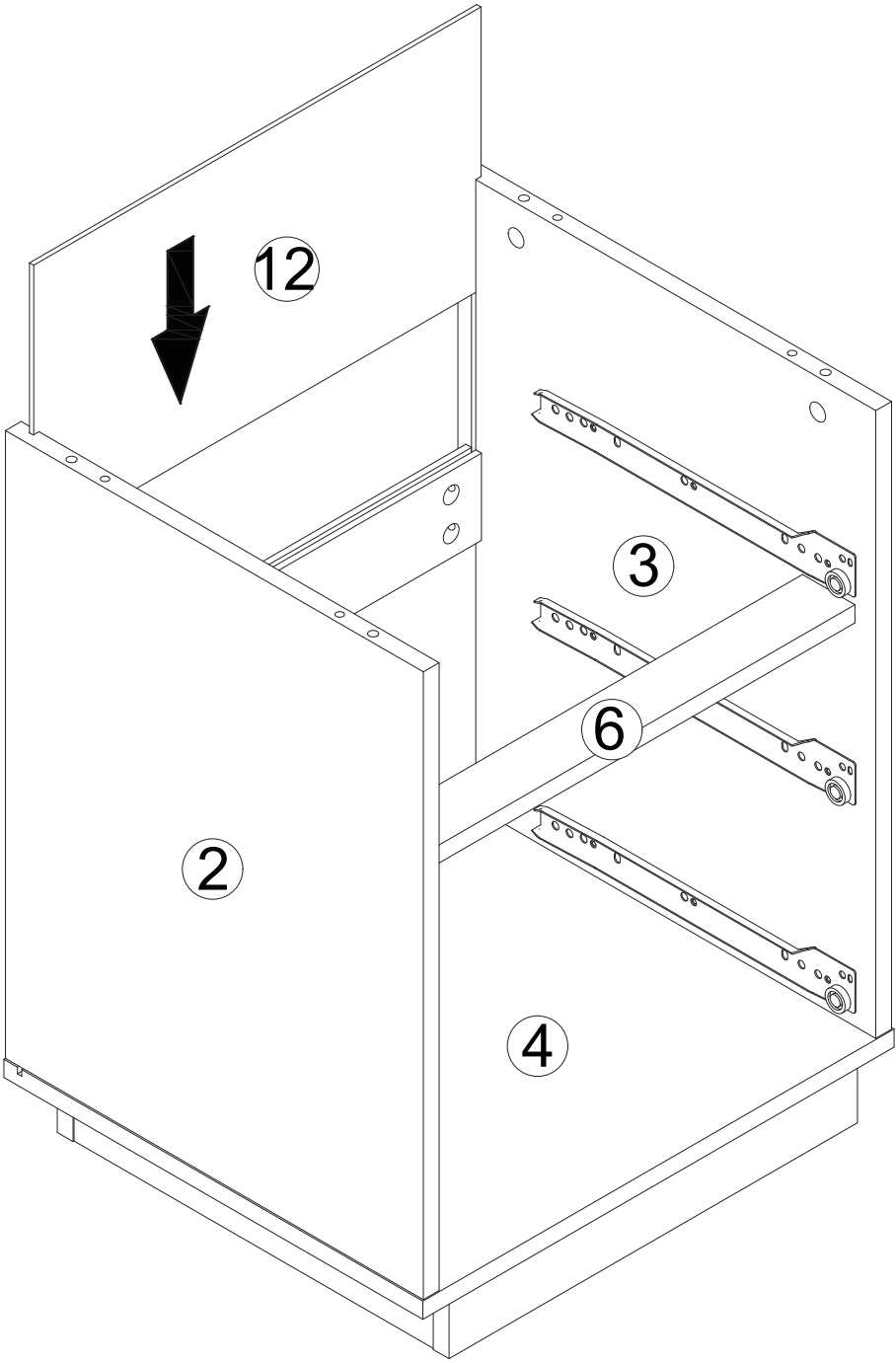

STEP 12

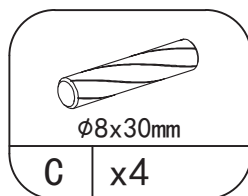
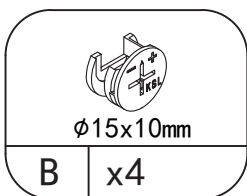
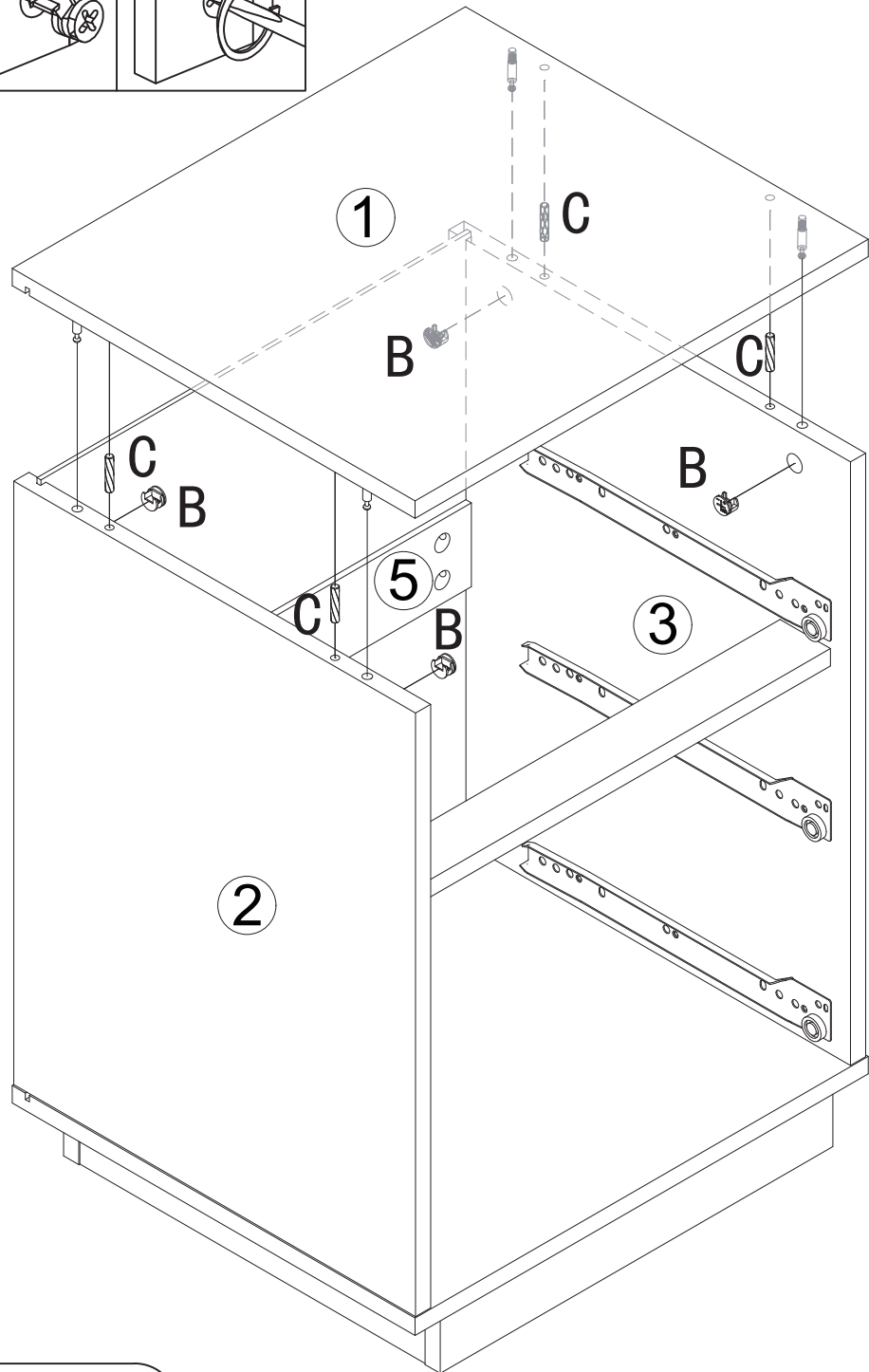
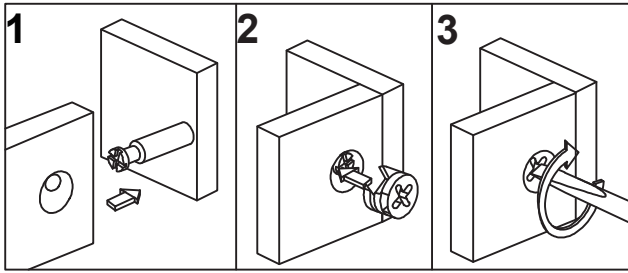



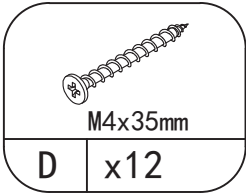
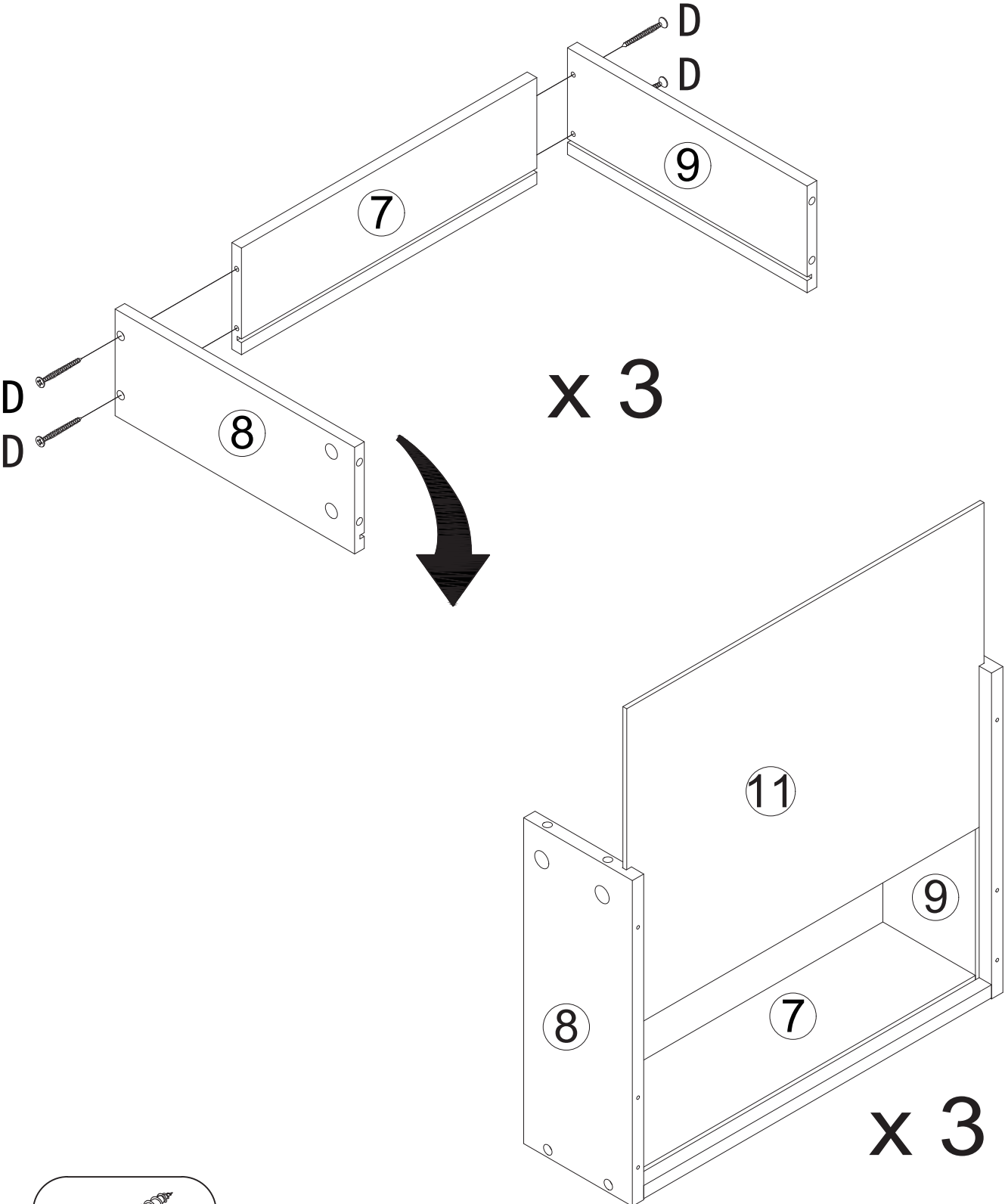

STEP 13

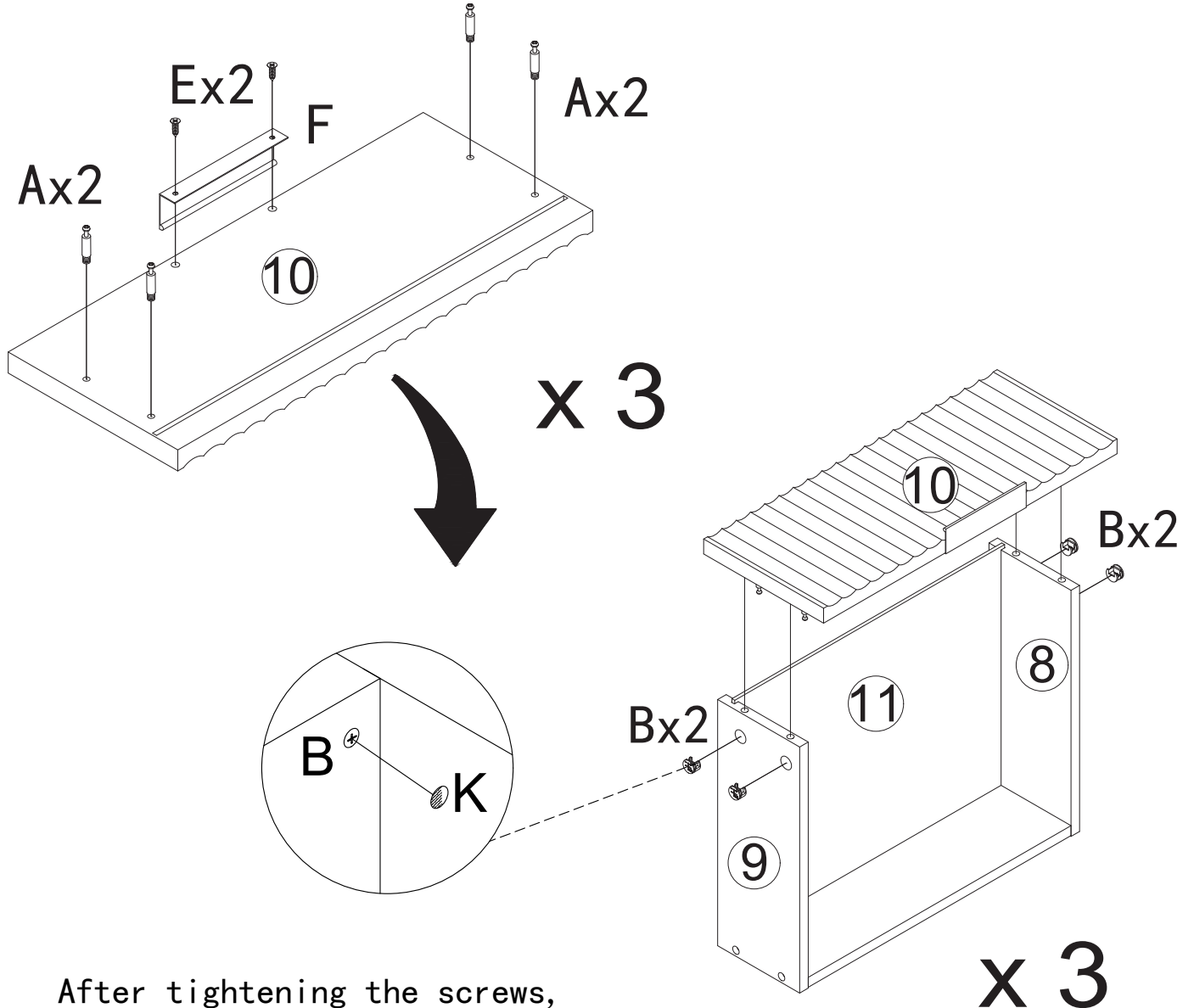
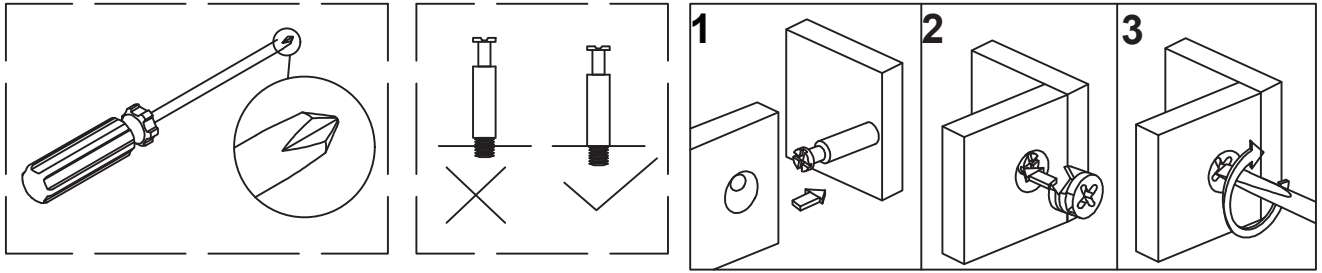

STEP 14

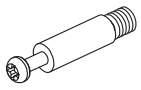

After tightening the screws,
place the decorative sticker
over the screw hole

				
M6x35mm	Ø15x10mm	M3*12mm		
A x12	B x12	E x6	F x3	K x12

STEP 15

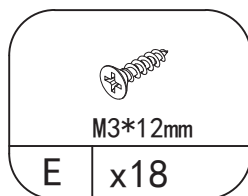
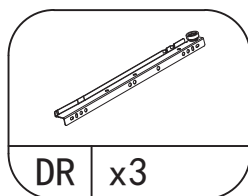
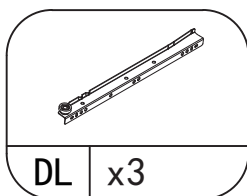
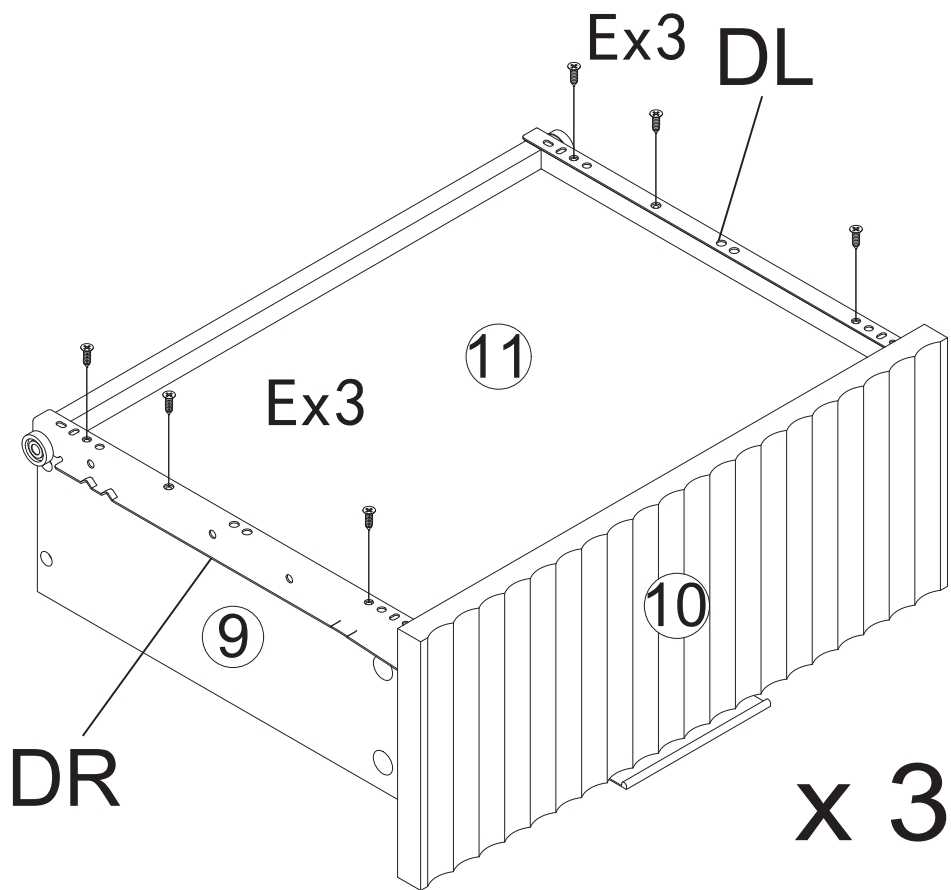
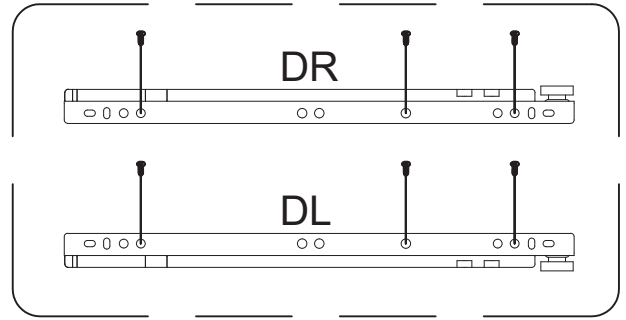

STEP 16

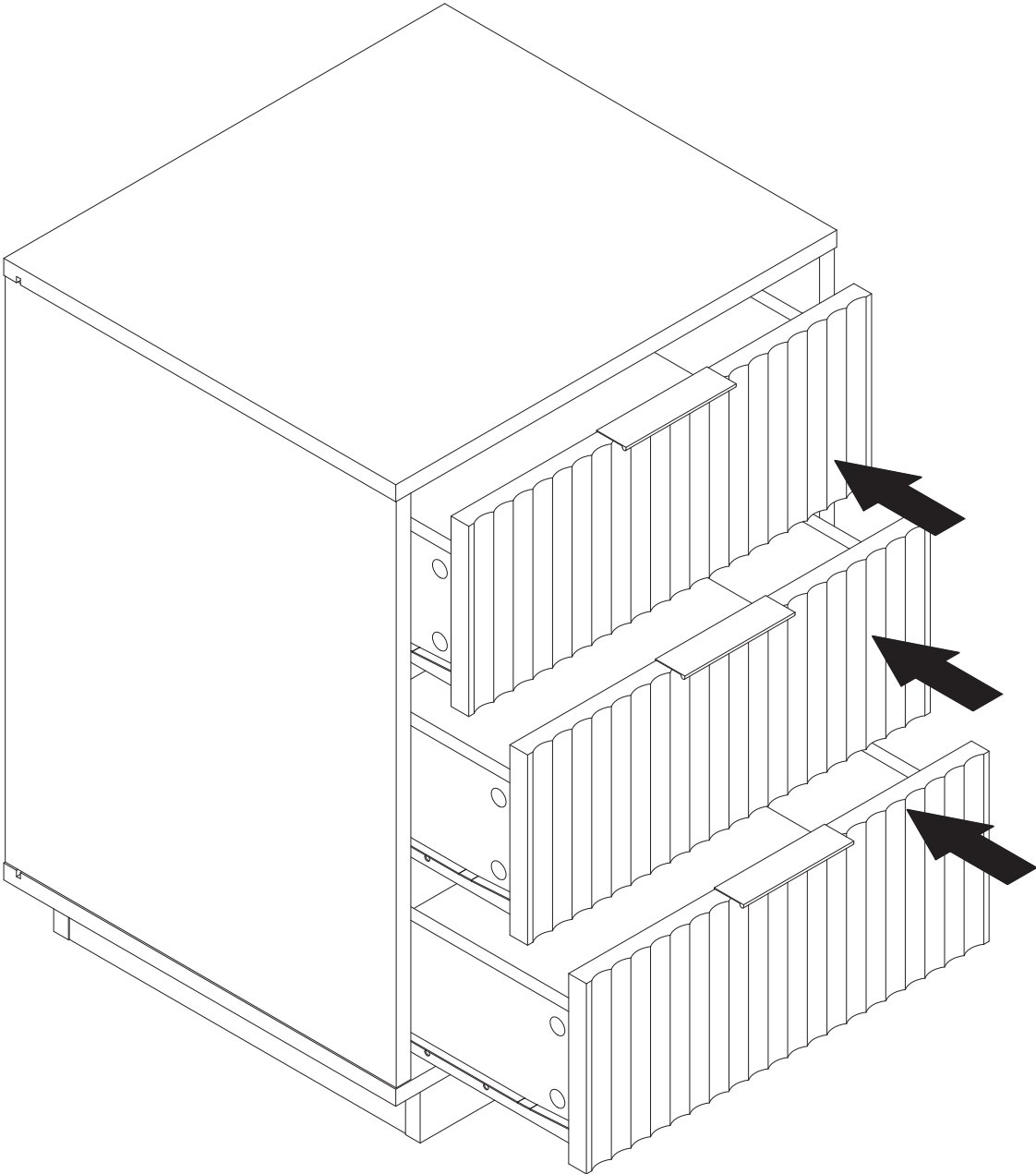
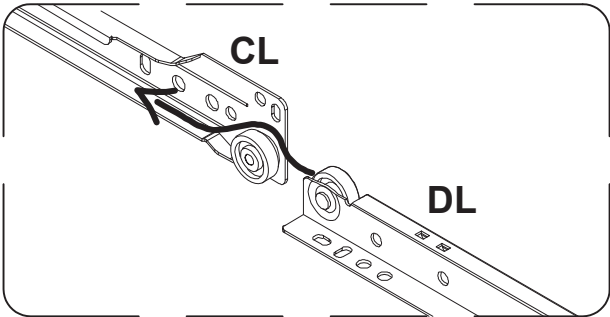
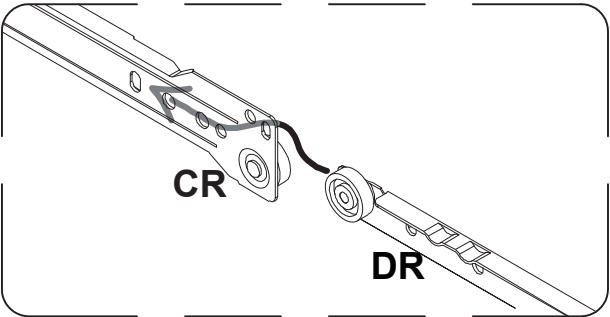

STEP 17

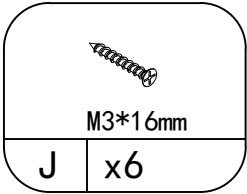
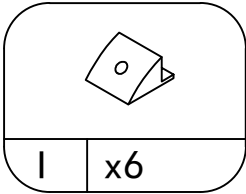
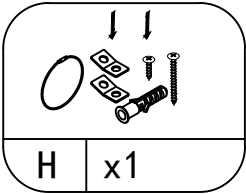
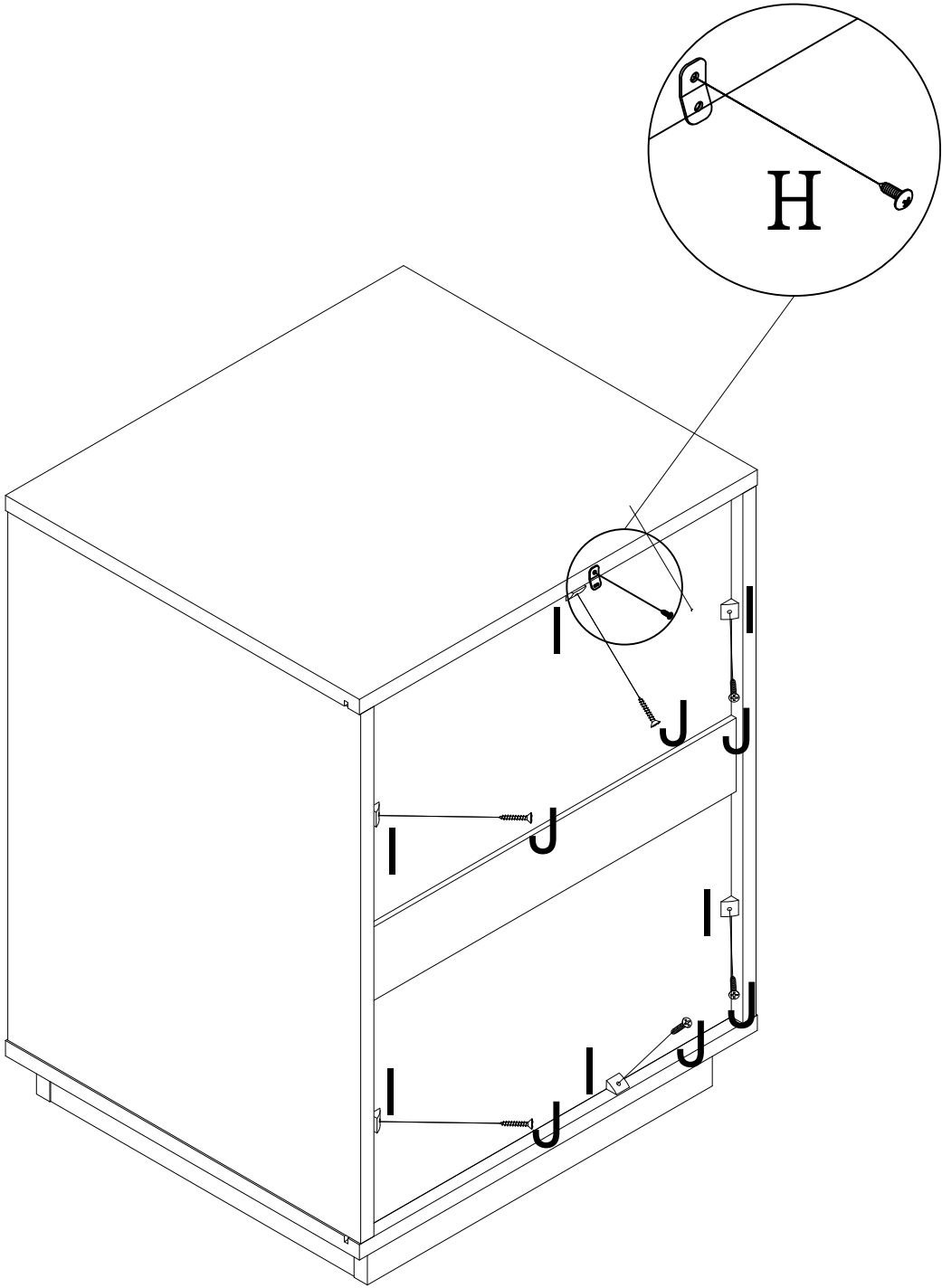

STEP 18

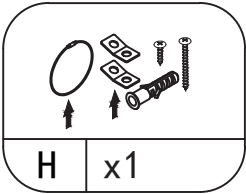
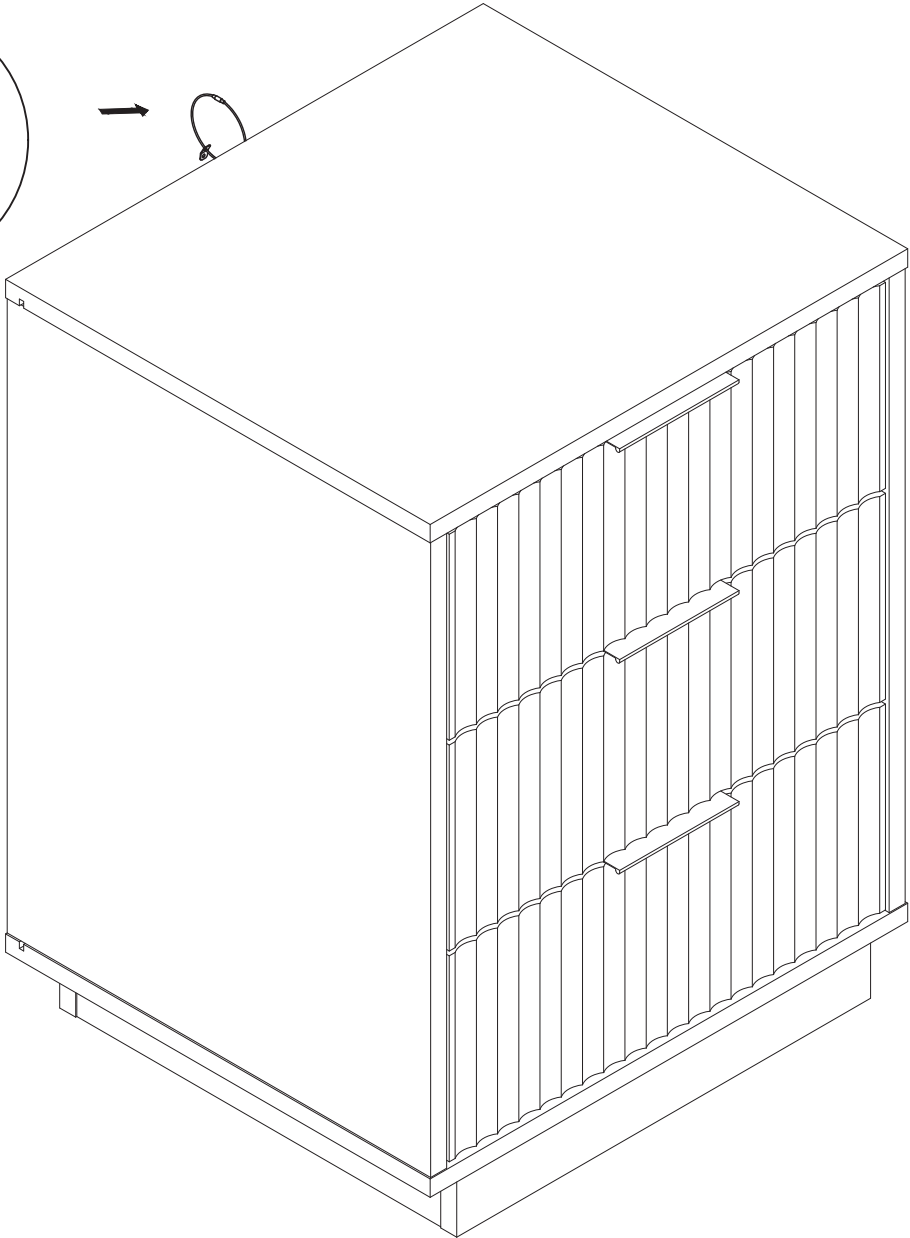
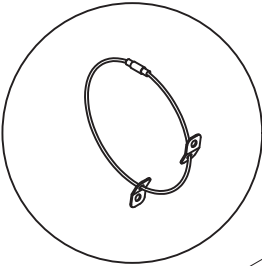
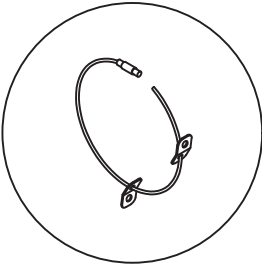

STEP 19

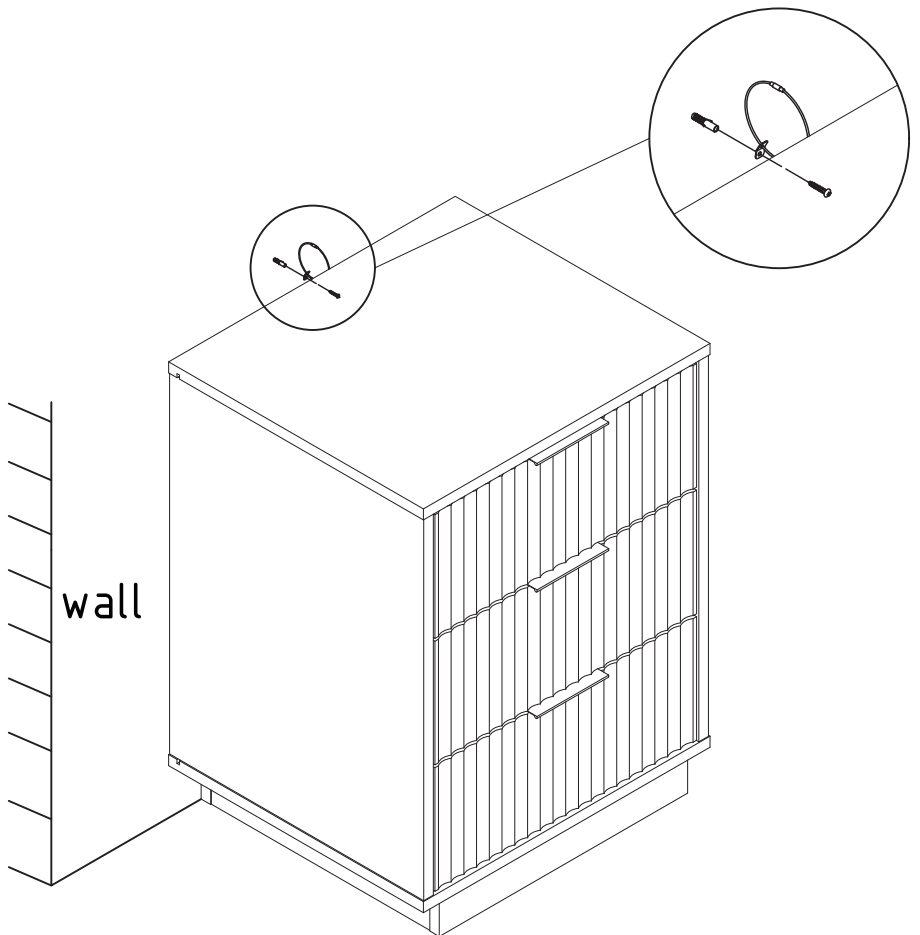
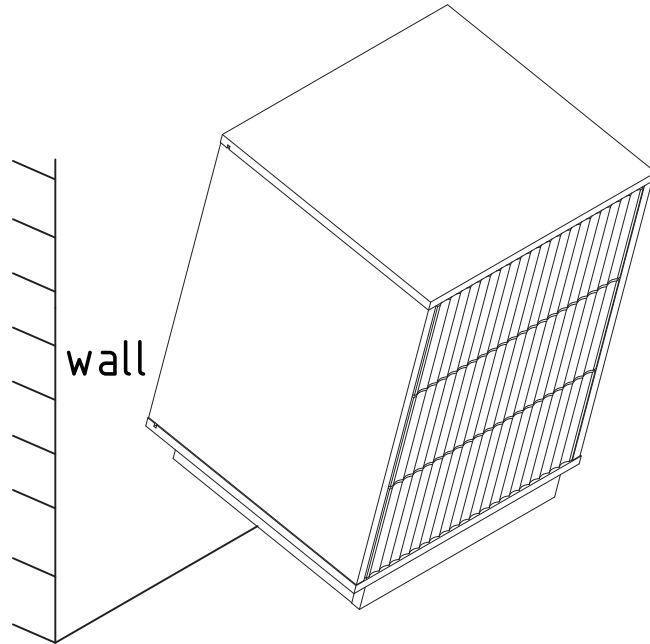
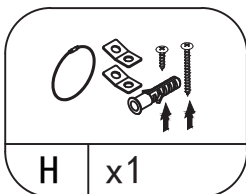
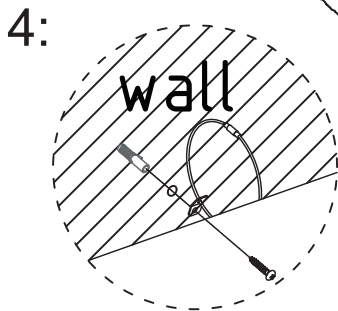
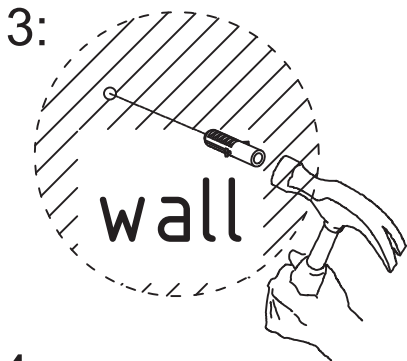
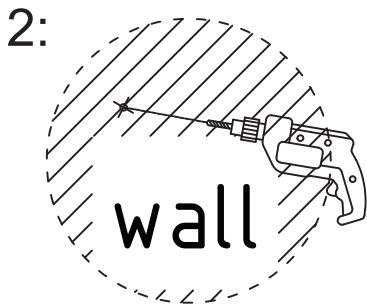
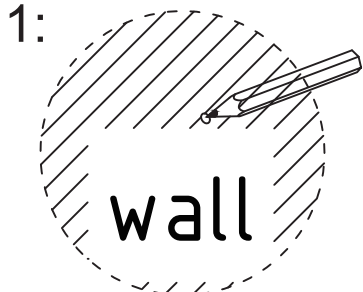



MAINTENANCE AND CARE

Prevent Moisture Damage:

Safeguard your laminate furniture by keeping it in a dry environment. Store the furniture away from damp areas and water sources.

Sunlight Shielding:

Shield your laminate furniture from direct sunlight to prevent color fading and surface deterioration. Consider using curtains or blinds for protection, especially if direct sunlight exposure is unavoidable.

Regular Care:

Maintain your laminate furniture's appearance by gently wiping surfaces with a damp cloth. Avoid using overly wet cloths or abrasive cleaning tools.

Avoid Scratches:

Protect the furniture surface from scratches by refraining from placing sharp or hard objects on it. When moving the furniture, be cautious not to scrape the legs against the floor.

Proper Weight Distribution:

Prevent structural damage by placing heavy objects on stable support surfaces rather than directly on the laminate furniture's surface. This simple step can prolong the life of your furniture.



MANTENIMIENTO Y CUIDADO

Evite daños por humedad:

Proteja sus muebles laminados manteniéndolos en un ambiente seco. Guarde los muebles lejos de zonas húmedas y fuentes de agua.

Protéjalos de la luz solar:

Proteja sus muebles laminados de la luz solar directa para evitar la pérdida de color y el deterioro de la superficie. Considere el uso de cortinas o persianas como protección, especialmente si la exposición directa a la luz solar es inevitable.

Cuidado regular:

Mantenga el aspecto de sus muebles laminados limpiando suavemente las superficies con un paño húmedo. Evite utilizar paños demasiado húmedos o herramientas de limpieza abrasivas.

Evite los arañazos:

Proteja la superficie del mueble de arañazos evitando colocar objetos afilados o duros sobre ella. Al mover el mueble, tenga cuidado de no raspar las patas contra el suelo.

Distribución adecuada del peso:

Evite daños estructurales colocando objetos pesados sobre superficies de apoyo estables en lugar de directamente sobre la superficie del mueble laminado. Este sencillo paso puede prolongar la vida de sus muebles.



WARRANTY INFORMATION

Warranty Coverage: Our warranty provides protection against manufacturing defects in materials and workmanship for a specified period from the date of purchase, as outlined in the accompanying warranty documentation.

Exclusions: The warranty does not cover damages resulting from misuse, negligence, accidents, normal wear and tear, unauthorized repairs or modifications, improper assembly, or failure to adhere to the care and maintenance guidelines provided.

WARRANTY CLAIM PROCESS

To initiate a return, please follow these steps:

1. Log into your account and go to the "Your Orders" section.
2. Locate the order containing the item you wish to return.
3. Contact our customer service for assistance in obtaining a prepaid return label.
4. Once you receive the return label, securely affix it to the package.
5. You can then choose to drop off the package at a designated carrier location or arrange for a pickup.
6. After we receive and inspect the returned product, we will initiate the refund process.
7. The refund will be credited back to the original payment method used during the purchase.
8. Typically, refunds are processed within 3-5 business days.

Cobertura de la garantía: Nuestra garantía proporciona protección contra defectos de fabricación en materiales y mano de obra durante un período determinado a partir de la fecha de compra, como se indica en la documentación de garantía adjunta.

Exclusiones: La garantía no cubre los daños resultantes de uso indebido, negligencia, accidentes, desgaste normal, reparaciones o modificaciones no autorizadas, montaje incorrecto o incumplimiento de las directrices de cuidado y mantenimiento proporcionadas. las directrices de cuidado y mantenimiento proporcionadas.

PROCESO DE RECLAMACIÓN DE LA GARANTÍA

Para iniciar una devolución siga estos pasos:

- 1 Accede a tu cuenta y ve a la sección "Tus pedidos"
2. Localiza el pedido que contiene el artículo que deseas devolver.
3. Ponte en contacto con nuestro servicio de atención al cliente para que te ayuden a obtener una etiqueta de devolución prepagada.
4. Una vez que reciba la etiqueta de devolución, fíjela firmemente al paquete.
5. A continuación, puede optar por depositar el paquete en el lugar designado por el transportista o solicitar que lo recojan.
6. Después de que recibamos e inspeccionemos el producto devuelto, iniciaremos el proceso de reembolso.
7. El reembolso se abonará de nuevo al método de pago original utilizado durante la compra.
8. Normalmente, los reembolsos se procesan en un plazo de 3 a 5 días laborables.