

TWO HANDLE LAVATORY CENTERSET FAUCETS

2350305

1.2GPM 4.5L/min

You may need



For easy installation of your faucet you will need:

To READ ALL the instructions completely before beginning.
To READ ALL warnings, care, and maintenance information.

Cleaning and Care

Care should be given to the cleaning of this product. Although its finish is extremely durable, it can be damaged by harsh abrasives or polish. To clean, simply wipe gently with a damp cloth and blot dry with a soft towel.

With 1.2 gpm are compliant with California water efficiency regulations, Complies with California Proposition 65 and with the Federal Safe Drinking Water Act.

Maintenance

If faucet exhibits very low flow:

A. Remove and clean aerator (2) with hand,
B. Shut off water supply valves.
Replace valve assembly (4).
When reinstalling parts, make sure bonnet nut (5) is tightened securely with a wrench.

If faucet leaks from under handle:

Using a wrench, ensure bonnet nut (5) is tight.
If leak persists:
Shut off water supply valves. Replace valve assembly (4). When reinstalling parts, make sure bonnet nut (5) is tightened securely with a wrench.

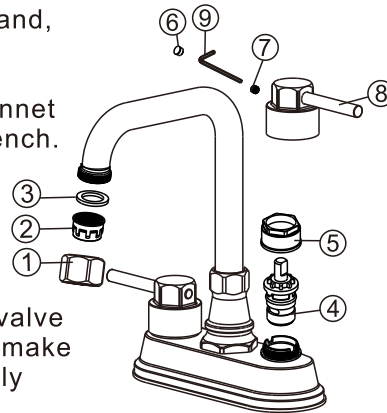

If faucet leaks from spout outlet:

Shut off water supply valves.
Replace valve assembly (4).
When reinstalling parts, make sure bonnet nut (5) is tightened securely with a wrench.
Install valve assembly (4) correctly for proper handle rotation.

unit:inch (mm)

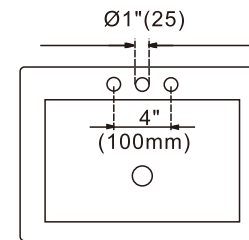
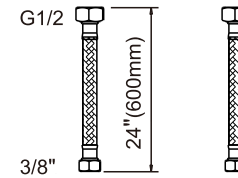
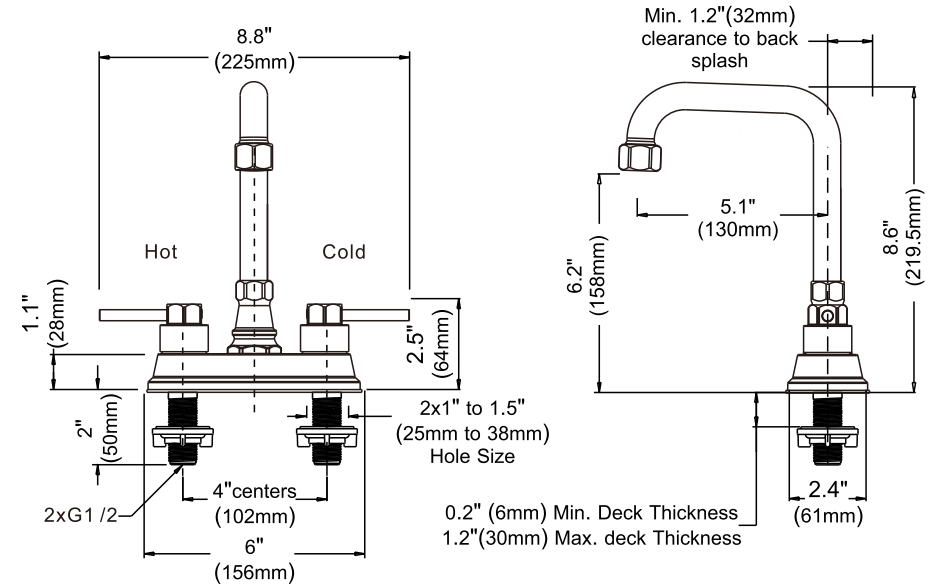

Pre drilled hole size:
1" (25mm)
Hole Size

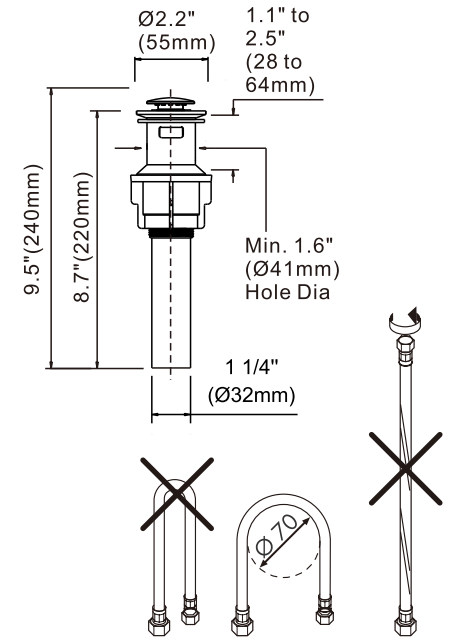

OPERATION

- Double levers style handles
- Maximum handle(s) rotation angle is 90° to full on
- Rotate hot side counter clockwise to open (clockwise to close)
- Rotate cold side clockwise to open (counter clockwise to close)

Notes

Before installing the valves, clean the water pipe thoroughly to avoid dirt and deposits.

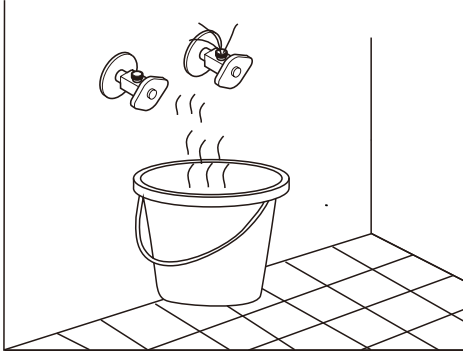

2

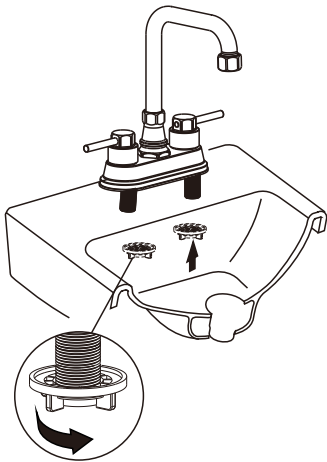

Attach the mounting nut to the hot and cold threaded mounting shanks and tighten faucet to basin.

1

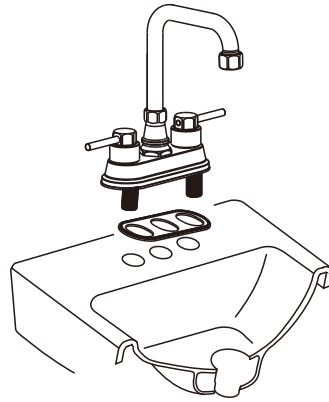

Provided with necessary models.
OPTION: Use silicone under the base if deck is uneven.

3

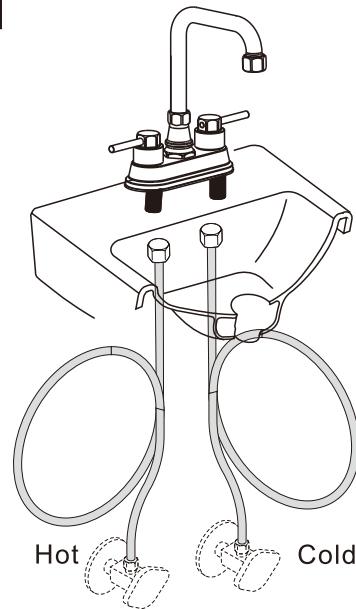

Attach supply lines .
Do not overtighten.
Turn water back on.

4

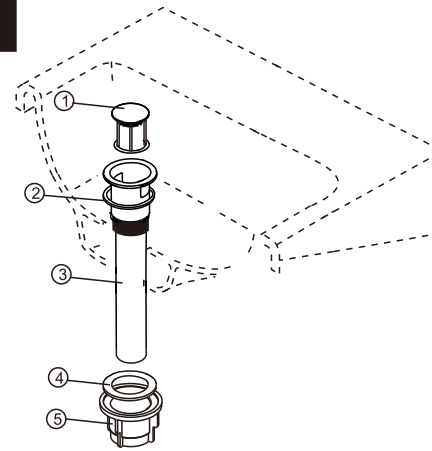

1.Remove the washer (2) , black gasket (4) and nut (5) from the assembly.
2.Slide washer (2) up to underside of flange (3).
Insert flange (3) and washer (2) into sink and secure with the black gasket (4) washer and nut (5) from underneath the sink.
3.Put down and check the Spring loaded stopper (1).
4. Connect assembly to drain.

5

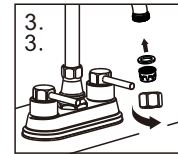
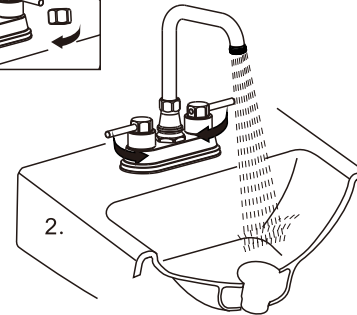
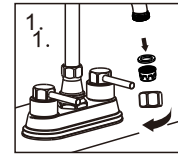

To flush debris from the plumbing system:

1. Remove the aerator by hand.
2. Run hot and cold water for one minute.
3. Replace the aerator.

6

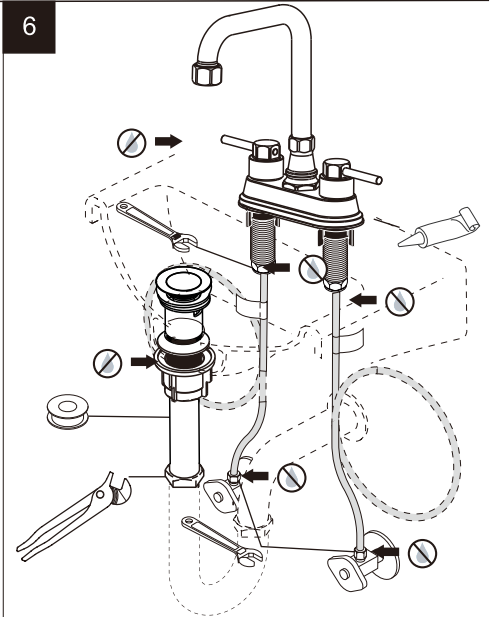

Repeat for other hose connection making sure the hose with the hot label is connected to the hot supply valve and the other hose is connected to the cold supply valve.
FLUSH SYSTEM/CHECK FOR LEAKS.
Turn on hot and cold water supplies and flush water lines for one minute. Check all connections at arrows for leaks. Retighten if necessary, but do not overtighten.