

LUKY-W6FM7236/8440

Colors/Finishes:Matte Black(MB), Brushed Gold(BG), Brushed White(BW)

## INSTALLATION

# LIGHTED FRAME MIRROR Lighting and Defogger

## IMPORTANT SAFETY INSTRUCTIONS

When using an electrical furnishing, basic precautions should always be followed, Requires two(2) person in installation.



### DANGER

**READ AND FOLLOW ALL INSTRUCTIONS BEFORE USING THIS MIRROR.**



### WARNING

To reduce the risk of burns, fire, electric shock or injury to persons. Use this furnishing only for its intended use as described in these instructions. Do not use attachments not recommended by the manufacturer. Never drop or insert any object into any opening. Do not use outdoors.



### WARNING

Risk of electric shock. Connect this furnishing to a properly grounded circuit only. See Grounding instructions.

## GROUNDING INSTRUCTIONS:



### WARNING

This product must be connected to a grounded metal, permanent wiring system, or an equipment-grounding conductor must be run with the circuit conductors and connected to the equipment-grounding terminal or lead on the product.

An Electrical option cabinet must be wired to a 20 Amp GFI (Ground Fault Interrupter) protected circuit when used in bathrooms and all other locations required by the National Electric Code.

---

**NOTE:** To ensure the normal use of product, it is required to set out wires as per the regulations of IEE. The product is only applicate to the indoor installation. The installation must be executed by a professional electrician, wrong installation may lead to product damage and personal injury.

---

PLEASE SAVE THESE INSTRUCTIONS FOR FUTURE REFERENCE

ALL RIGHTS RESERVED

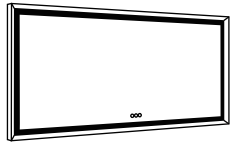

LUKY-W6FM7236/8440

Colors/Finishes:Matte Black(MB), Brushed Gold(BG), Brushed White(BW)

# INSTALLATION

## LIGHTED FRAME MIRROR Lighting and Defogger

### TOOLS REQUIRED FOR ASSEMBLY

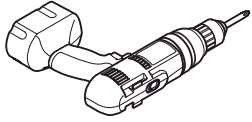

Electrical Drill



1/8" Drill Bit

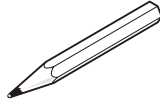

Pencil



Phillips  
Screwdriver



Tape Measure

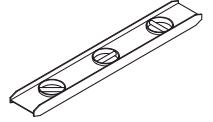

Level

### PARTS INCLUDED

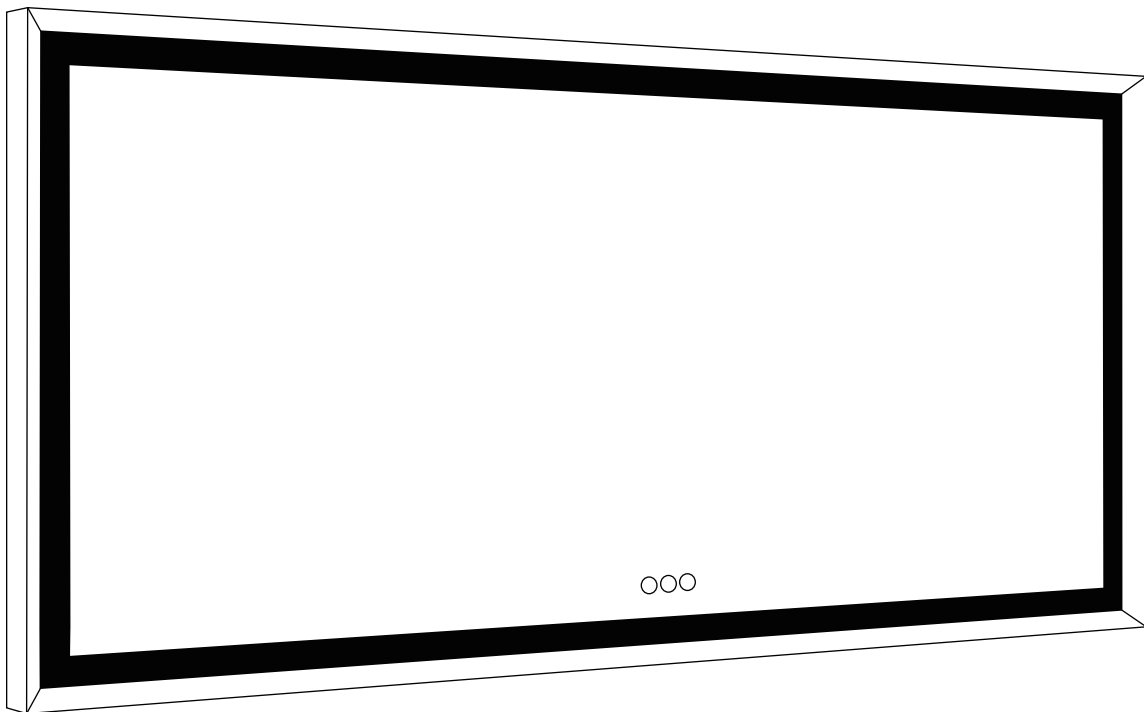

Mirror

### HARDWARE INCLUDED (not shown actual size)

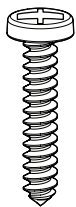

SCREW

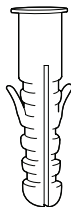

WALL PLUG

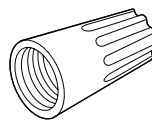

WIRE CONNECTOR

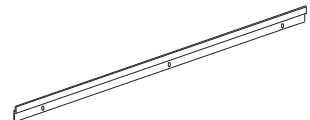

HANGING BAR



**NOTE:** Determine overall mirror dimensions before proceeding to installation.

\*All dimensions & specifications are approximate and subject to change without notice.

\*Accessories and parts may vary from the picture above. Depends on the product model and size.

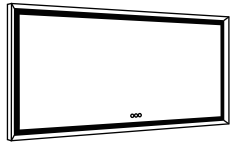

LUKY-W6FM7236/8440

Colors/Finishes:Matte Black(MB), Brushed Gold(BG), Brushed White(BW)

## INSTALLATION

# LIGHTED FRAME MIRROR Lighting and Defogger

## ELECTRIC CONNECTIONS

### ALL WIRING SHOULD BE DONE BY A QUALIFIED LICENCED ELECTRICIAN



**WARNING:** Shut off power before wiring the mirror.



**WARNING:** An Electrical option mirror must be wired to a 20 Amp GFI (Ground Fault Interrupter) protected circuit when used in bathrooms and all other locations required by the National Electric Code.



**WARNING:** This mirror must be connected to a grounded, metal permanent wiring system or an equipment-grounding conductor must be run with the circuit conductors and connected to the equipment grounding terminal or lead on the mirror.



**CAUTION:** Requires 120 VAC 20 Amp GFI protected circuit.

vertical hanging

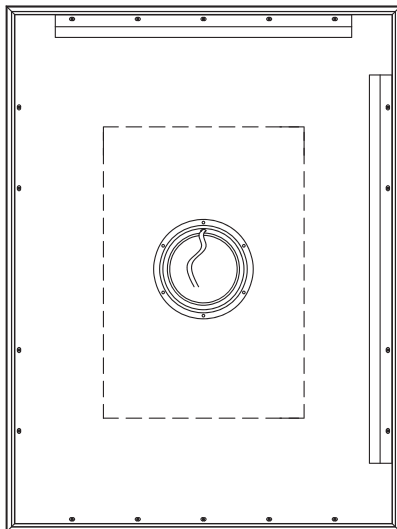

horizontal hanging

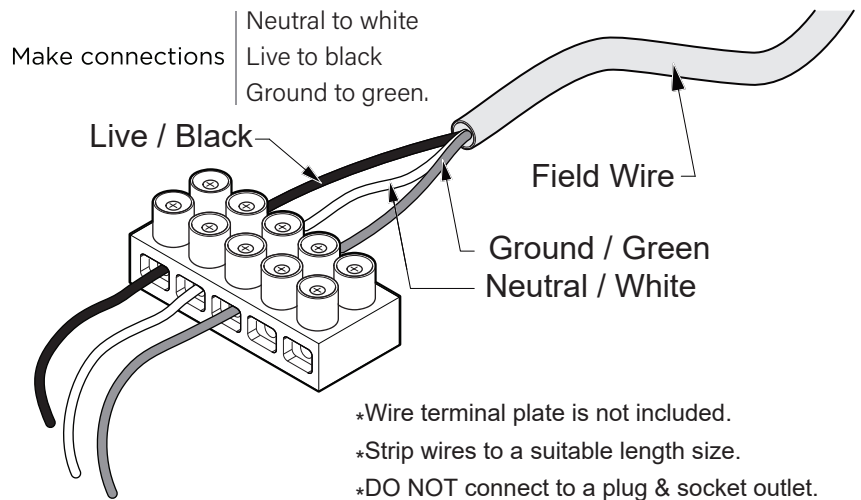

**Electric wiring:** Be sure to provide enough wire to make the proper and safe connection to the Field/Power.

### MIRROR FEATURES

- 5mm copper free silver mirror
- High quality LED Lighting
- CRI 90+, 3000-6000K CCT, IP44
- Color temperature and dimming
- Separate controlled defogger
- Vertical and horizontal mount options

# INSTALLATION INSTRUCTIONS

**1**

## PLACEMENT

Select the desired position of the mirror.  
Level and mark the location.  
(vertical and horizontal mounting options)

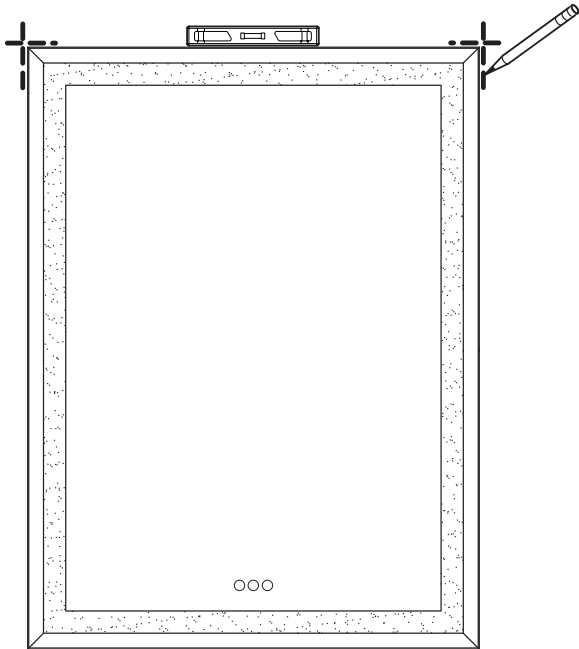

**2**

## SUPPORT LOCATION

Measure the hanging bar holes and mark the drilling locations ensure marking are leveled.

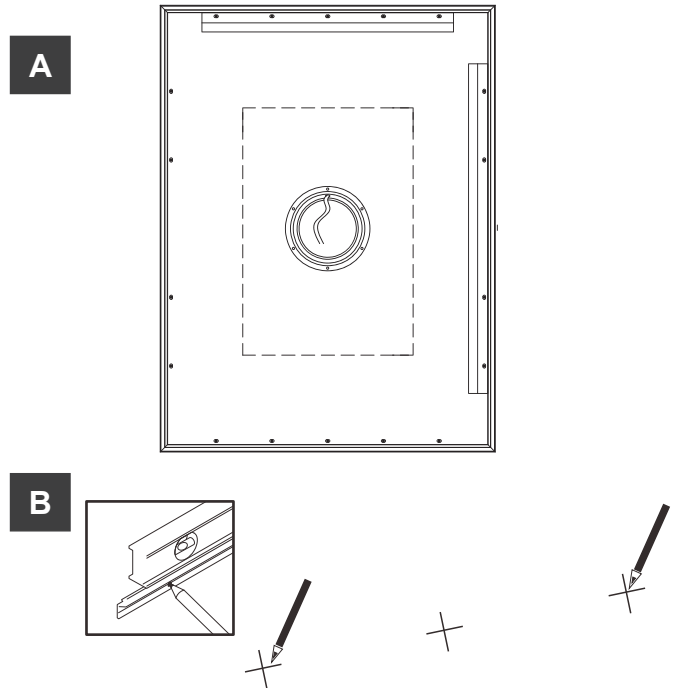

**3**

## INSTALL SCREWS

Using a drill, make holes on solid wall, and fill with supplied plugs and screws into hanging bar holes tightly.

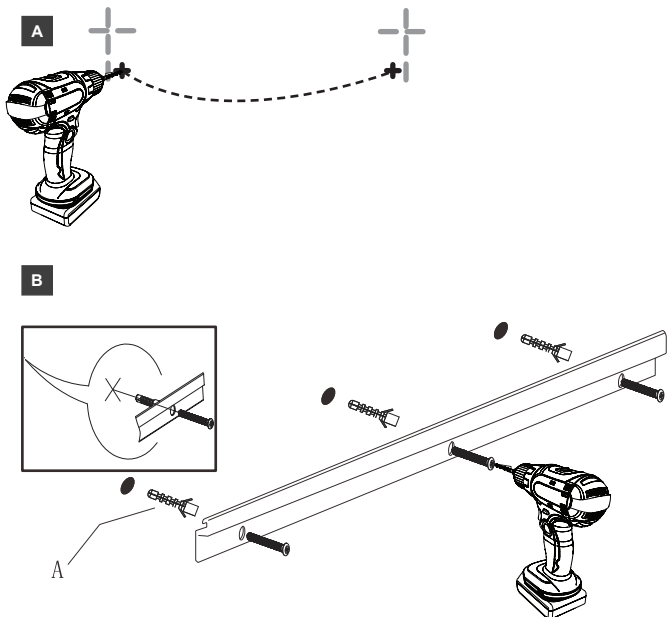

**4**

## POWER OFF

Please turn off all the power before the mirror wires connection.

## Power Off

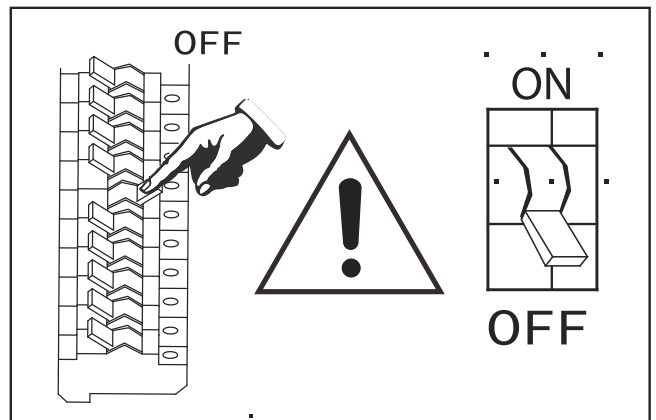

# INSTALLATION INSTRUCTIONS

## 5 CONNECTION

Use the wire connector connect to external power supply, and pushing the power supply wires into the junction box.

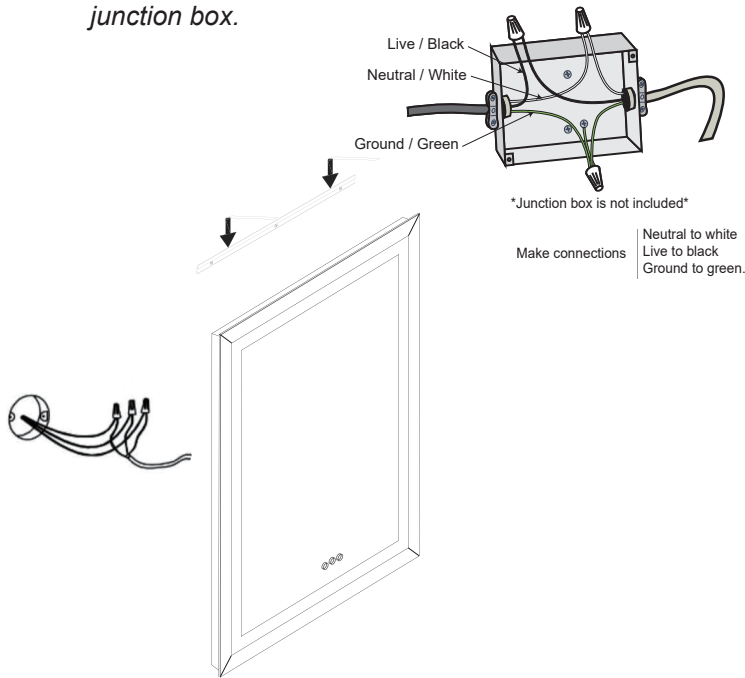

## 6

**Turn on the power**  
Hang up the mirror stable then turn on the power.

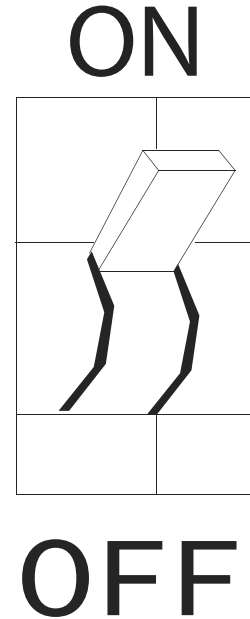

# TOUCH SWITCH SETTING UP

## How to use Touch Switch:

### Left Touch Sensor



Short touch to ON/OFF lighting.  
Light brightness 5%-100% control by holding.  
Release the button when the light reaches the desired brightness.



“Switch” sign

### Middle Touch Sensor



Short touch to get the light temperature 6000K, 4000K and 3000K.  
Long touch to adjust the light temperature from 6000K-3000K.  
Release the button when the light reaches the desired color.

### Right Touch Sensor



Short touch to turn ON/OFF the defogger.

The mirror is equipped with memory function to preserve the previous brightness/color settings.

**\*Suggestion:** The mirror is equipped with memory function to preserve the previous brightness/color settings.

## WARNINGS:

1. Please do not use if you found the mirror have been broken.
2. Never put any sharp or heavy material on the mirror surface, other wise the glass mirror will be broken and body injury accidents may occur .
3. Turn off the power switch in storm lightning weather to avoid electric parts damage.

## Use and Maintenance:

### CAUTION:

#### ● USE

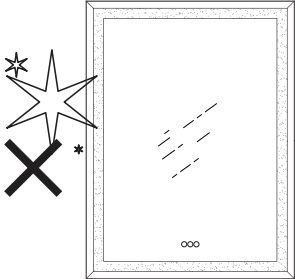
<p><b>1</b></p> 	<p>1. To avoid damage, do NOT knock the mirror with any hard objects;</p>
--	---

#### ● CLEANING

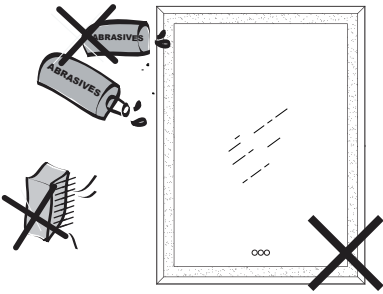
<p><b>2</b></p> 	<p>2. Do NOT clean the mirror with caustic cleaner. Do NOT wipe the mirror with Bristle brush;</p>
---	--

#### ● MAINTENANCE

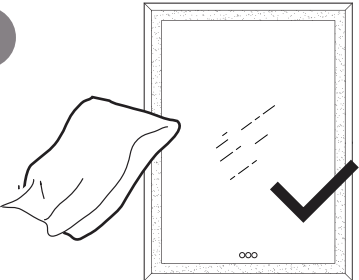
<p><b>3</b></p> 	<p>3. For daily maintenance, please use soft cloth and mild cleaner to clean the mirror.</p>
---	--