

Assembly Instruction

SECTIONAL SOFA

Box B

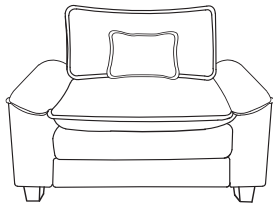

Box B+Box C

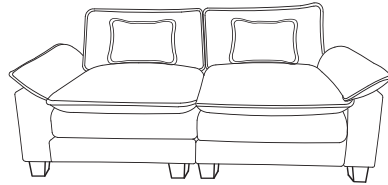

Box A/D+Box B

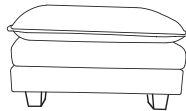
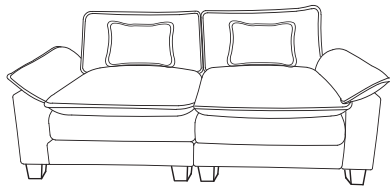

Box B+Box C+Box C

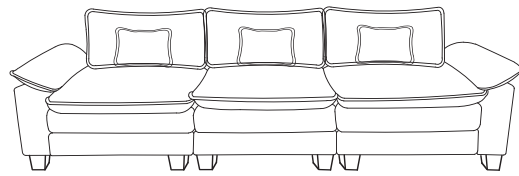

Box A/D+Box B+Box C

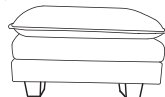
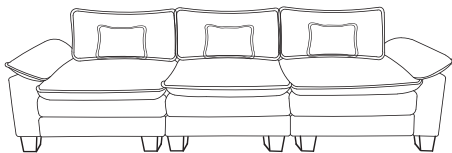

Box A/D+Box A/D+Box B

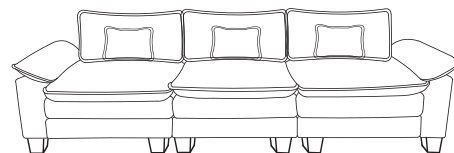

Thank you for choosing our product.

To ensure safe and satisfactory use of this product, please carefully read the below instructions beforehand.











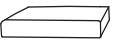

1. This sofa ships in several boxes, we recommend unpacking and starting assembly when all boxes are received.

2. Our cushions are vacuum packed for convenient shipping. Please allow 2-3 days for them to fully expand to their original shape and for any wrinkles to disappear.

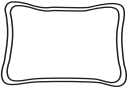









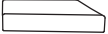





3. In the event that a part is damaged or missing, no need to return the product, we will gladly help and ship your replacement parts free of charge.

PART LIST & HARDWARE









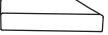

BOX A/D

A Seat frame  1PC	C Ottoman frame  1PC	D Backrest  1PC	G Seat cushion  1PC	H Ottoman cushion  1PC	I Back Cushion  1PC
M Leg  8PCS	S Arm pillow  1PC	L Gasket  8PCS+1PC	N Washer  8PCS+1PC	O M8*60mm Bolt  4PCS+1PC	P M8*80mm Bolt  2PCS
Q Butterfly Nut  2PCS	R Alley Key  1PC				

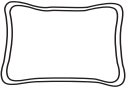
BOX B

A Seat frame  1PC	D Backrest  1PC	E Left armrest  1PC	F Right armrest  1PC	G Seat cushion  1PC	I Back Cushion  1PC
J Left armrest cushion  1PC	K Right armrest cushion  1PC	M Leg  4PCS	S Arm pillow  1PC	L Gasket  4PCS+1PC	N Washer  16PCS+1PC
O M8*60mm Bolt  12PCS+1PC	P M8*80mm Bolt  2PCS	Q Butterfly Nut  2PCS	R Alley Key  1PC		

BOX C

A Seat frame  1PC	D Backrest  1PC	G Seat cushion  1PC	I Back Cushion  1PC	M Leg  4PCS	S Arm pillow  1PC
L Gasket  4PCS+1PC	N Washer  8PCS+1PC	O M8*60mm Bolt  4PCS+1PC	P M8*80mm Bolt  2PCS	Q Butterfly Nut  2PCS	R Alley Key  1PC

Note: Please retain all boxes until you are certain that your product isn't damaged and that you do not wish to return it. Disposal of boxes may prevent our ability to resolve your request.

ASSEMBLY STEPS

STEP 1: Connect Left armrest (E) & Seat frame (A) with Bolts (O) and Washers(N).

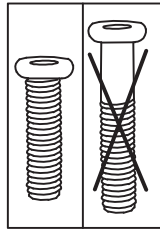
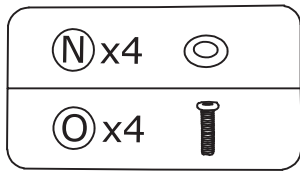
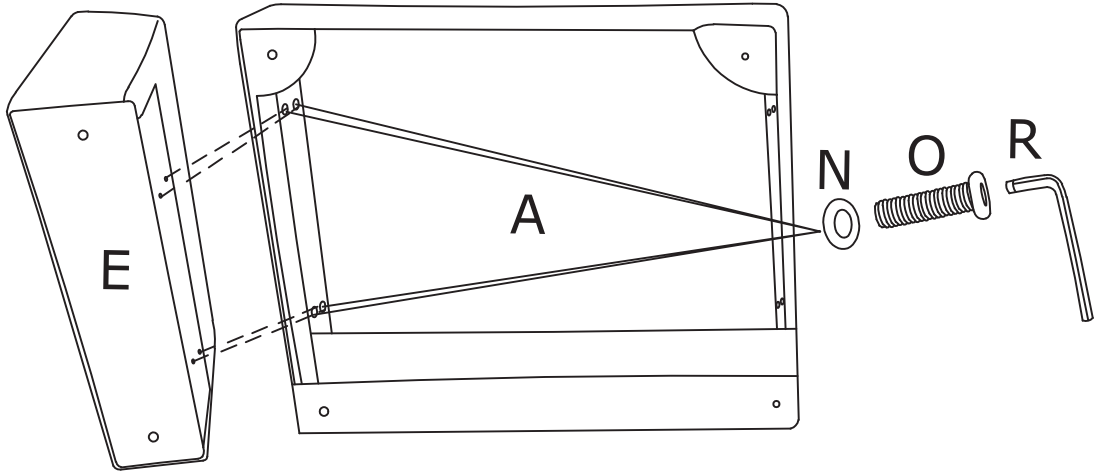

STEP 2: Connect Right armrest (F) & Seat frame (A) with Bolts (O) and Washers(N).

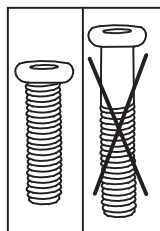
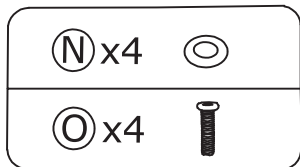
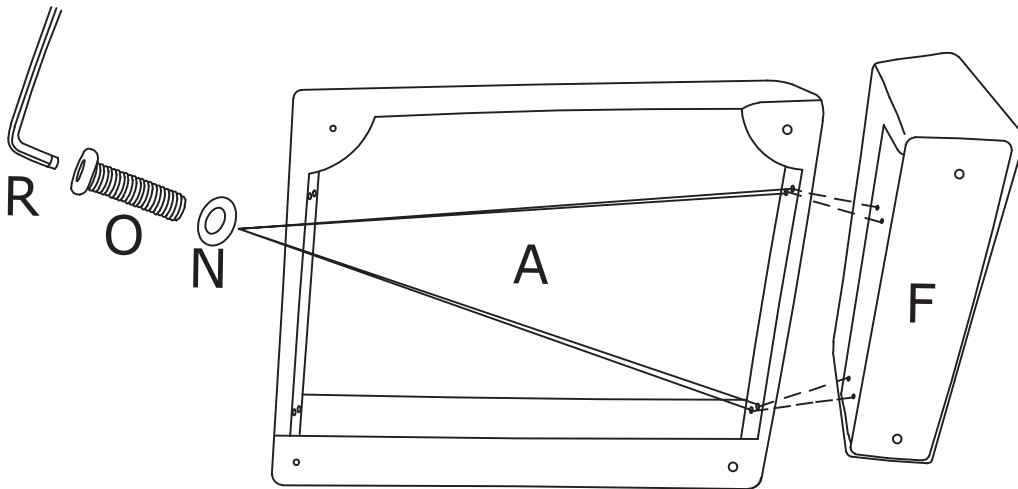

STEP 3: Connect Seat frame (A) and parts from step 1 & step 2 with Bolts (P), Washers (N) and Butterfly nuts (Q).

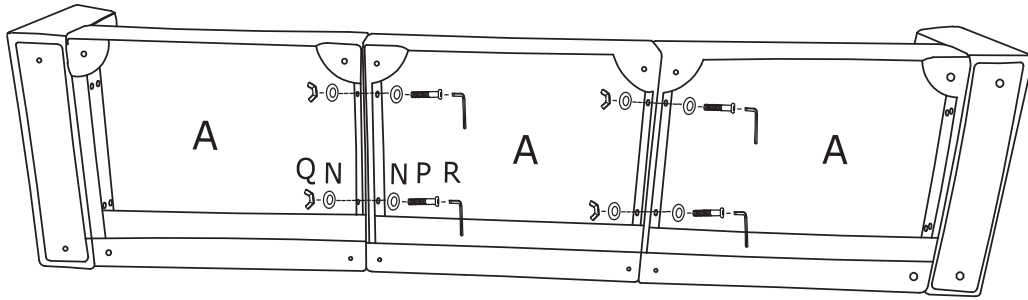

If you buy a multi-seater sofa, the assembly process is the same as for loveseat sofa

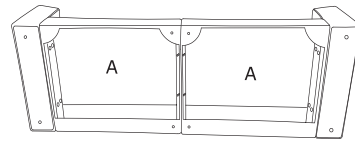
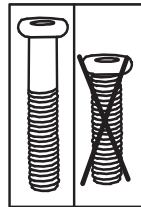
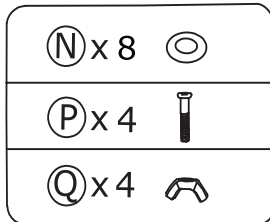

STEP 4: Install sofa legs, screw in Legs (M) and Gaskets (L).

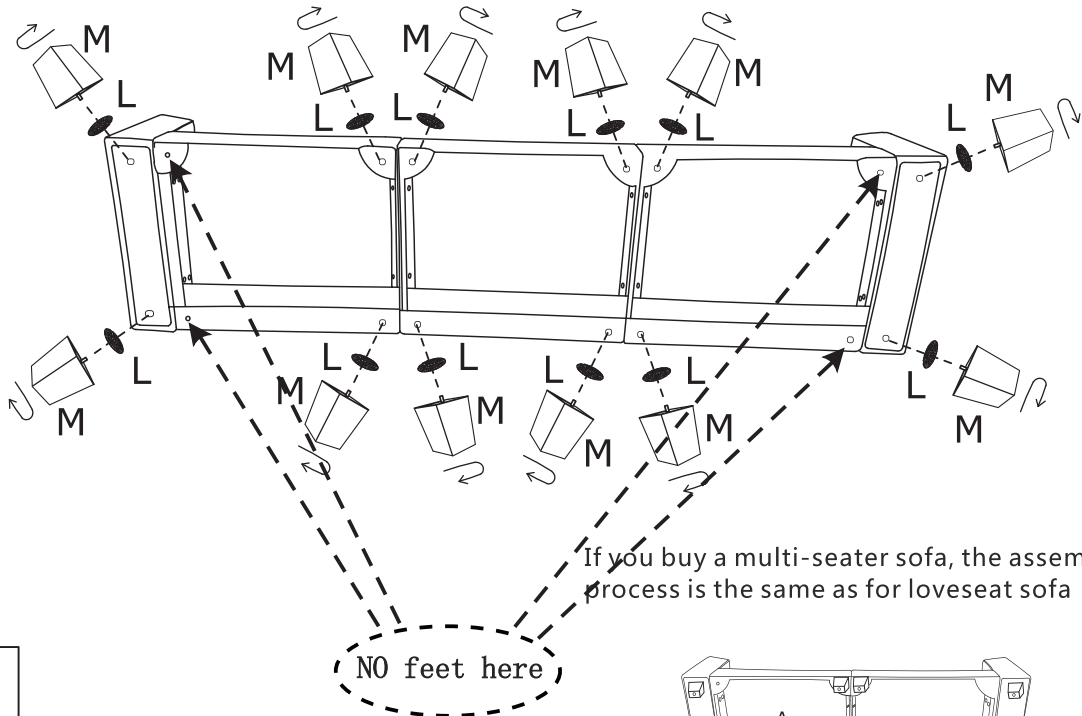

If you buy a multi-seater sofa, the assembly process is the same as for loveseat sofa

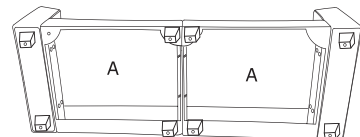
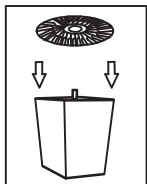

STEP 5: Install ottoman legs, screw in Legs (M) and Gaskets (L).

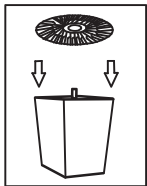
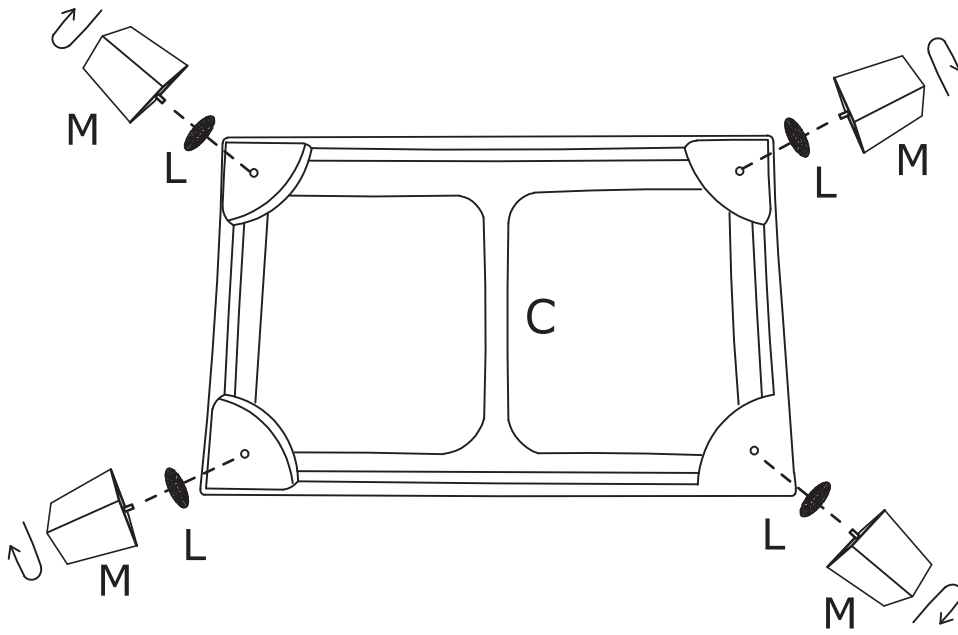

STEP 6: Line up the holes in the Backrest(D) with corresponding holes on the frame. Insert Bolts(O) and Washers(N), tighten securely after the have all been placed.

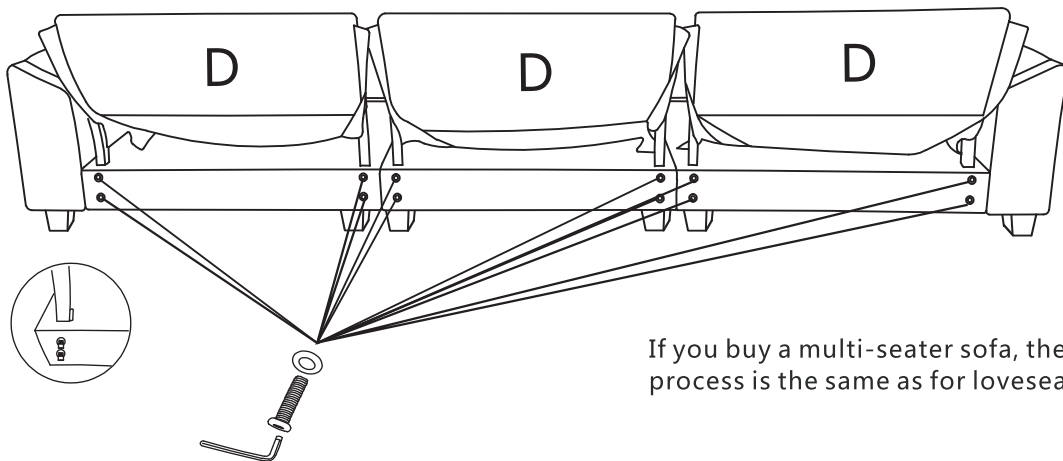

If you buy a multi-seater sofa, the assembly process is the same as for loveseat sofa

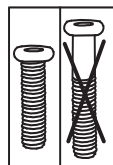
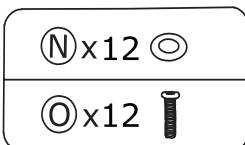
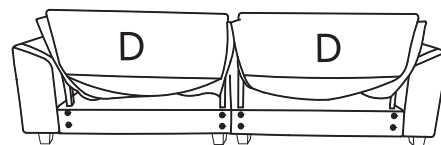

STEP 7: Use scissors to open all the vacuum sealed cushions and arm pillows. It may take 48-72hrs to fully expand back to its original shape.

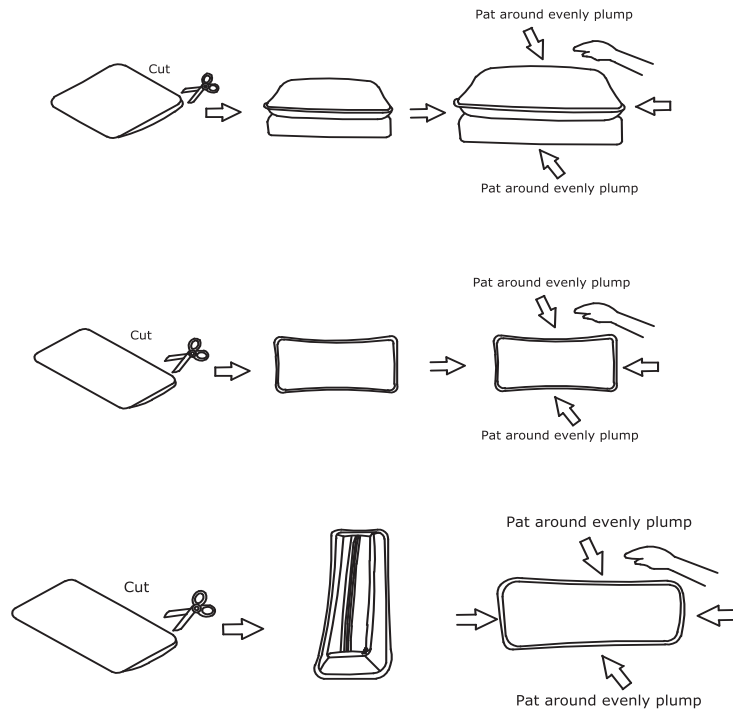

STEP 8: Attach arm pillows(J&K) into designated position.

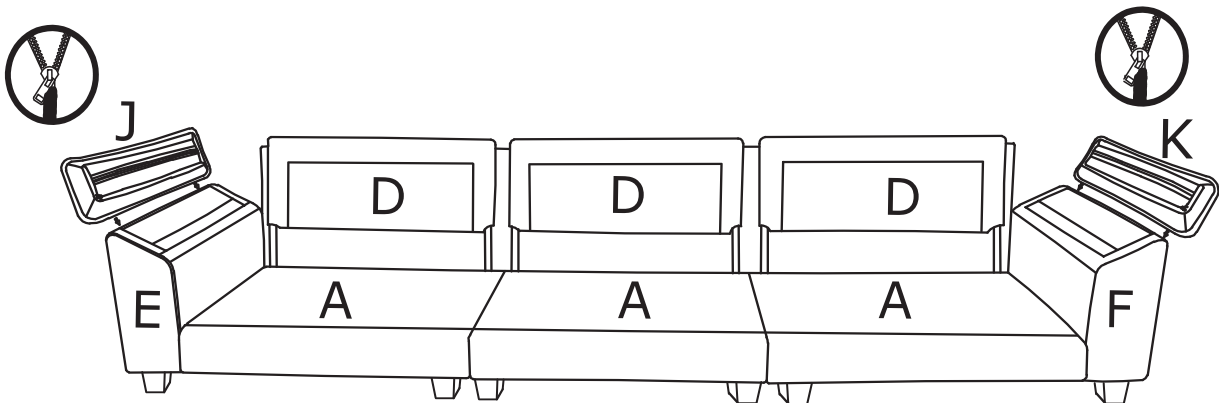

If you buy a multi-seater sofa, the assembly process is the same as for loveseat sofa

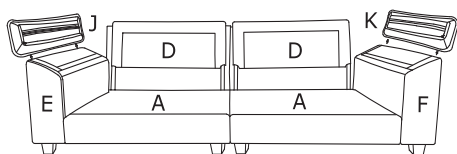

STEP 9: Add the cushions and you're done.

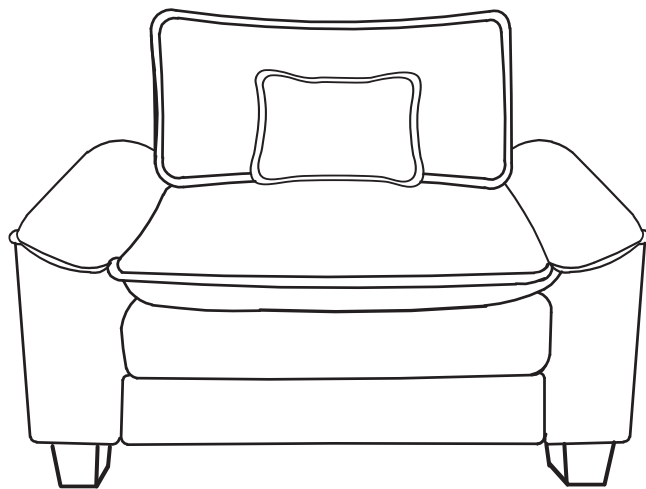
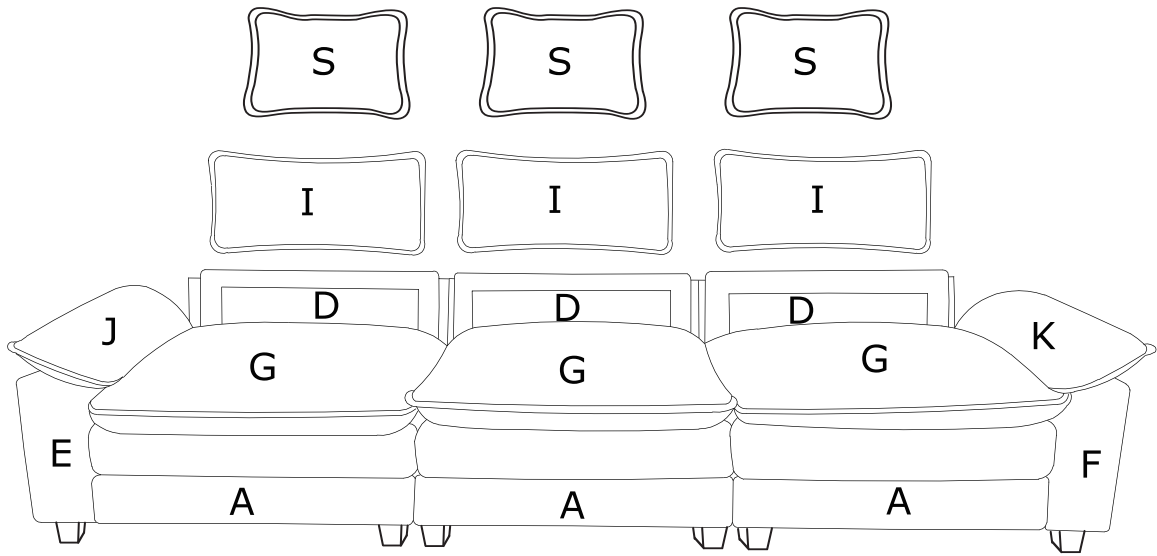

B&C

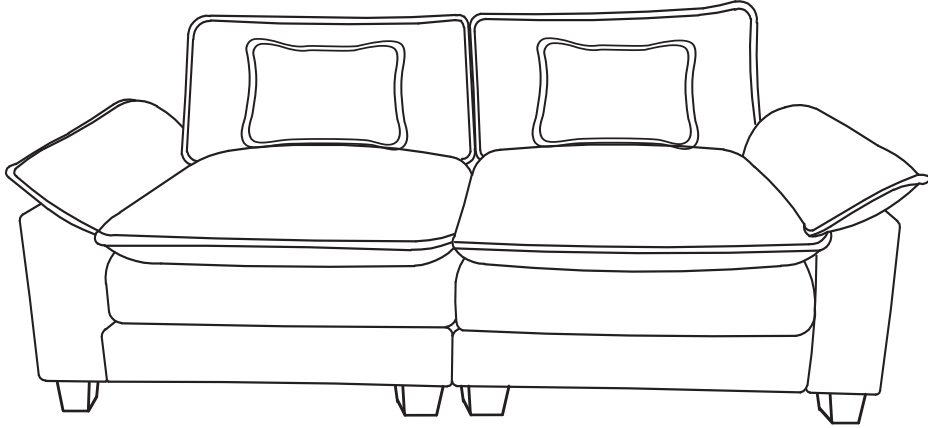

AD&B

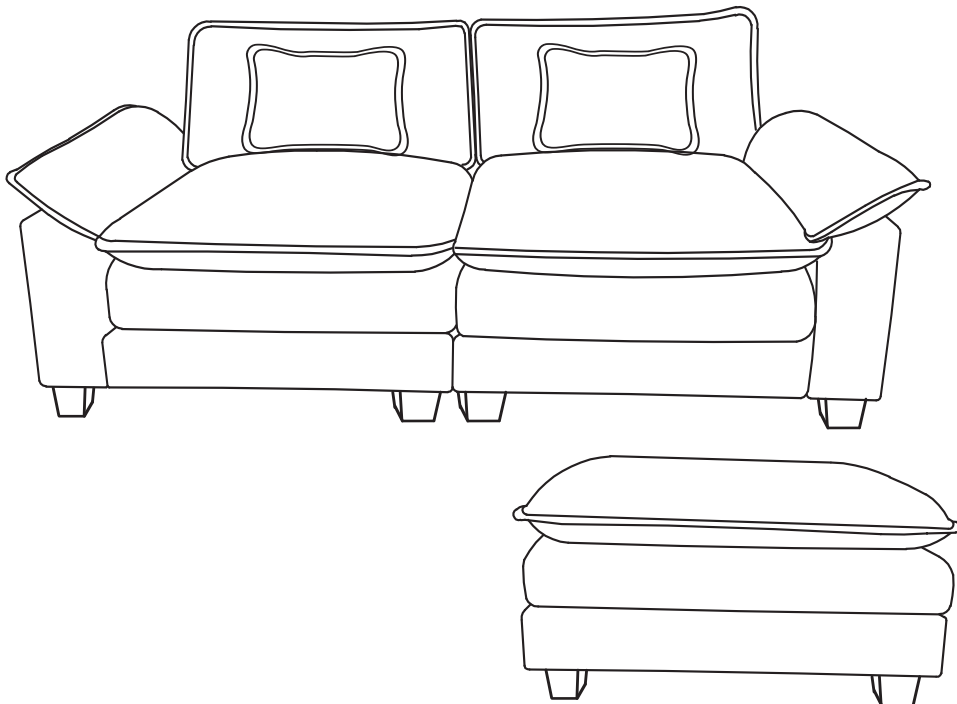

A/D&B&C

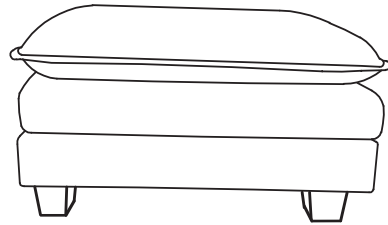
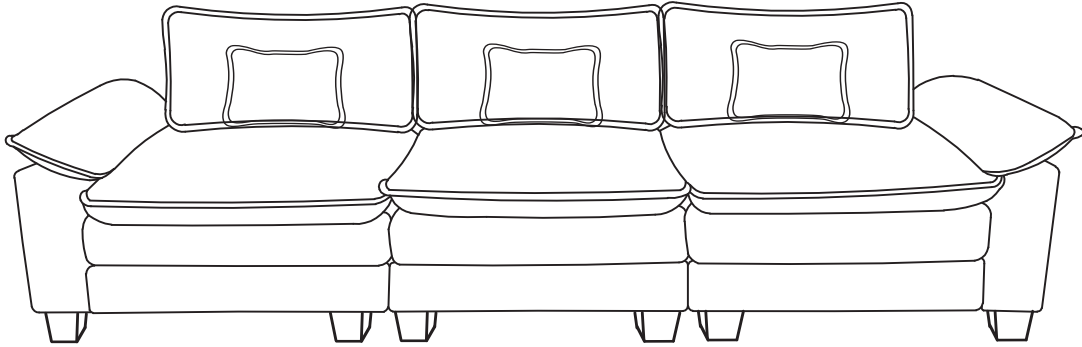

A/D&A/D&B

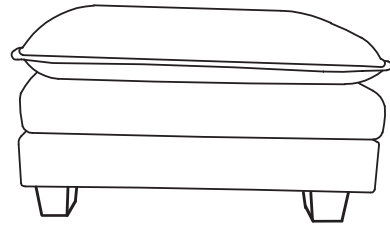
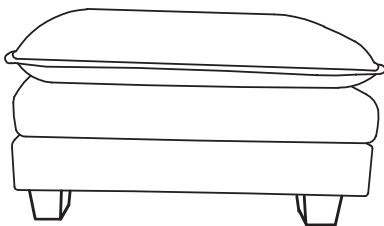
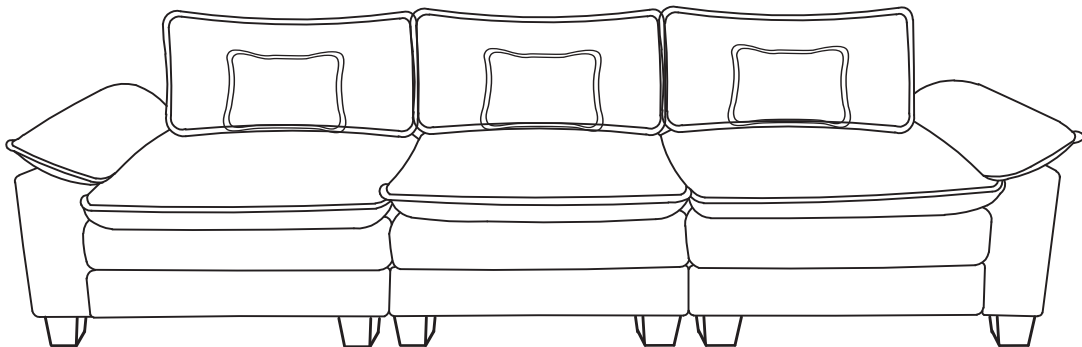

B&C&C

