

LED Exterior Garden

Ground Stake Mounting

EG17621

INSTALLATION SHEET

START FROM HERE

- Make sure **POWER** is **COMPLETELY OFF**
- Have your fixture installed by a qualified licensed electrician
- Prepare everything in a clear area
- Wear gloves at all time during this installation
- Read instructions carefully before you start assembly
- Keep this installation sheet for future reference

Please Note:

- This Kuzco LED fixture comes with pre-wired LED module(s)
- Unless instructed, Do Not touch any part of the LED module(s) as any unnecessary contact with the module could cause permanent damage
- 12V input with Outdoor Rated Low Voltage Transformer (Transformer supplied by others)
- Non-Dimming
- For typical ground stake mounting
- Luminaires shall not be installed within 10 feet of pool, spa or fountain

Technical Support: 1-855-855-8926

1. Remove fixture from its original package
2. Run fixture wire (1b) from the fixture (1a) through the mounting hole on top of the ground stake (3a)

3. Run transformer wire (provided by others) to location of intended install

Note: the low voltage wires are intended for shallow burial - less than 6 inches

4. Attach fixture thread (1d) (Note: fixture thread (1d) is 1/2-14 NPT) to ground stake (3a) by threading clockwise until it fits snugly

5. Fill outdoor rated wire nuts (2a) with silicone sealant (not provided). Cut and strip fixture wires (1b) and connect to transformer wire using outdoor rated wire nuts (2a) provided (Illustration 1)

Note: for multiple low-voltage garden light installation daisy-chain low voltage wire to each fixture from 12V transformer

6. Place stake (3a) in desired position and insert into ground until the flange of stake is flush with ground

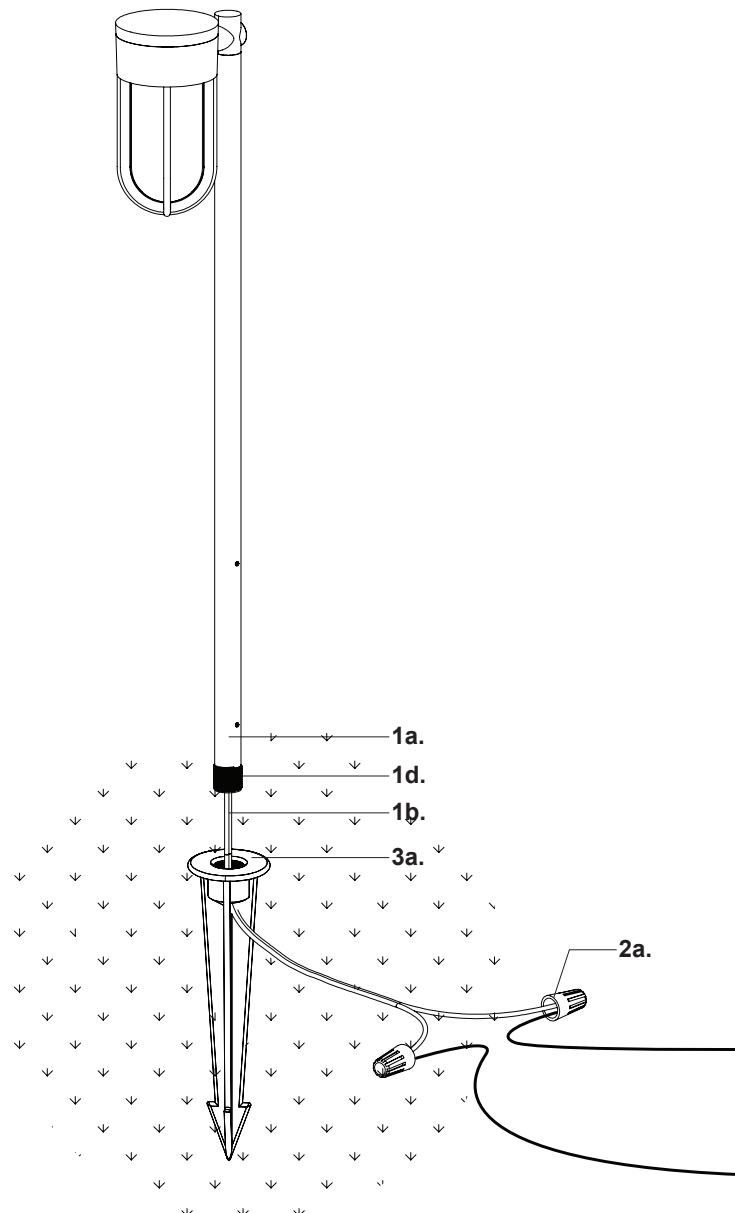
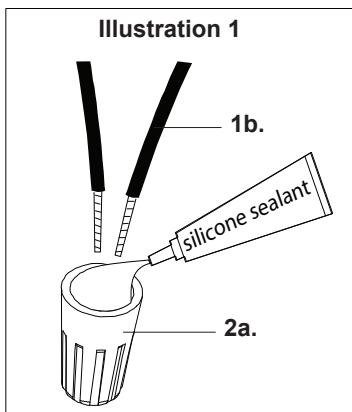

KUZCO

19054 28th Avenue Surrey, BC Canada V3Z 6M3
T: 604 538 7162 TF: 1-855 85 KUZCO F: 604 538 7196
W: kuzcolighting.com
20210422