

INSTRUCTION MANUAL

SECTIONAL SOFA

SHIP IN
3
BOX

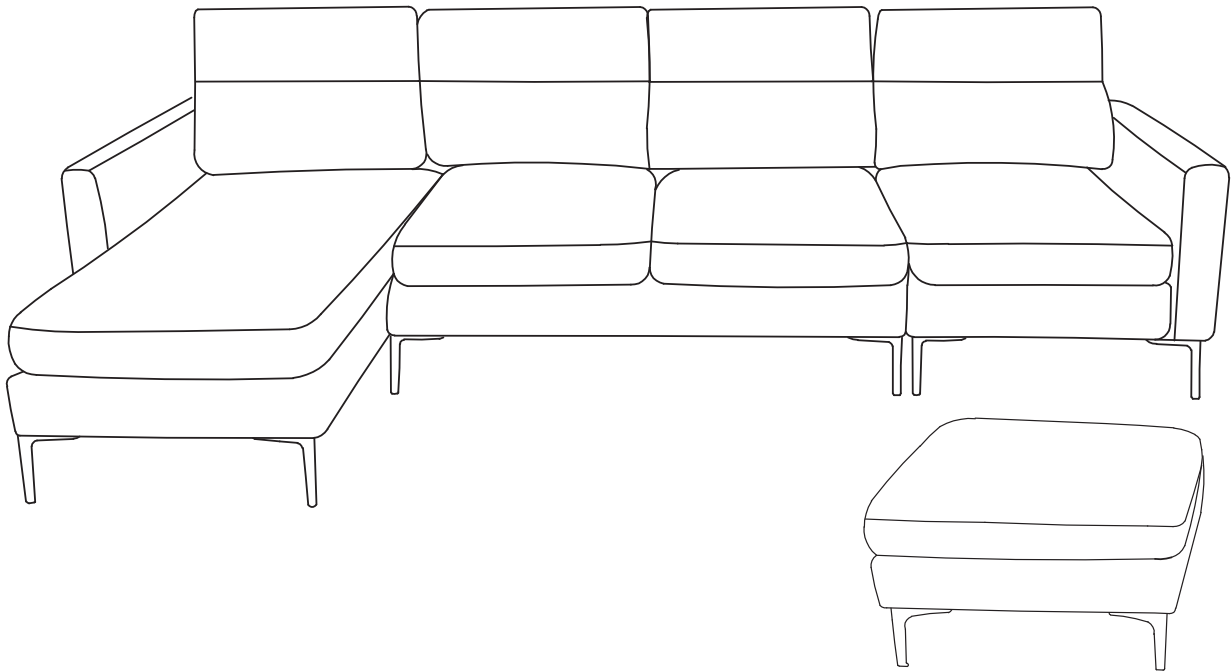

CUSTOMER SERVICE

Questions, Missing parts, Assembly help?

No need to return the product, we will gladly help and ship your replacement parts free of charge.

If you wish to return the product, please contact the retailer where the product was purchased.

PRE-ASSEMBLY INFORMATION

Please read this manual carefully before beginning assembly of this product. Keep this manual for future reference.

NOTICE

- Please keep this manual and hand it over when you transfer the product.
- Please read the following instructions carefully and use the product accordingly.
- This summary may not include every detail of all variations and considered steps. Please contact us when further information and help are needed.
- Please do not exceed the weight limitations of this item.
- Do not stand on or use any part of this item as a step ladder.
- If any parts are missing, broken, damaged, or worn, stop using this item until repairs are made and/or factory replacement parts are installed.
- Please assemble the item in a spacious room and do not place the unwrapped product directly on the ground to avoid damage.
- Do not use this item in a way inconsistent with the manufacturer' s instructions as this could void the product warranty.
- Periodically inspect screw tightness while the product is in use. If necessary, retighten to ensure structural integrity.
- To avoid the potential dangers of suffocation, please keep all parts and packaging (films, plastic bags and foam,etc.) away from children and pets.
- Do not use or store this item in the proximity of open flame or flammable/combustible chemicals.
- Do not expose product to direct sunlight exposure or rain,and do not put it in a humid place. Failure to do so may accelerate the distortion or discoloration.



TWO PERSON ASSEMBLY



UP TO 30 MINUTES FOR ASSEMBLY









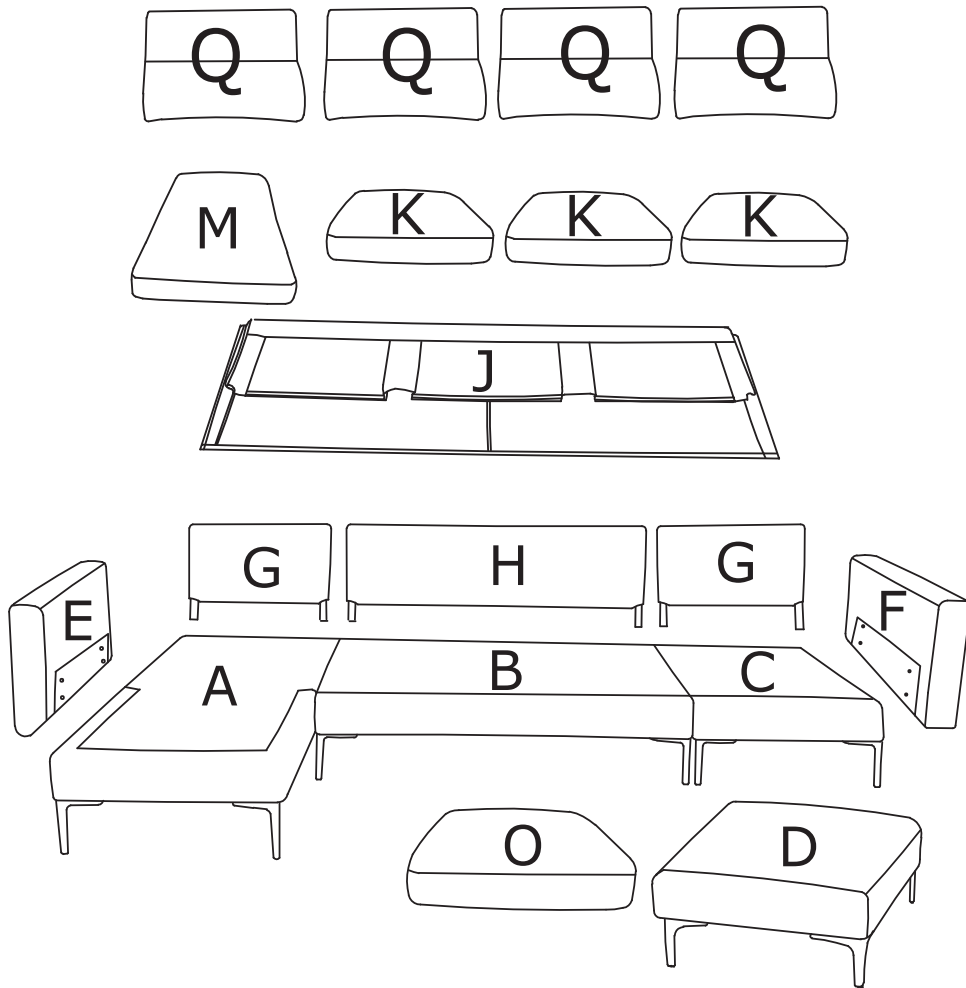

ONE SEAT WEIGHT LIMITATION:300LBS

IMPORTANT

- 1.Do not tighten bolts / screws completely until all bolts / screws are lined up and inserted into holes.
- 2.Do not over tighten screws and bolts to avoid stripping.
- 3.Please use hand tools to assemble this product. If you're using power tools, remember to set the tool to low torque to avoid damage.
- 4.We recommend unpacking and starting assembly of this item when 3 boxes are received,do not open the vacuum sealed cushions and pillows after the sofa frame is installed.

COMPONENTS



- | | | |
|---|---|--------------------|
| R |  | 17X Sofa Leg |
| X |  | 2+1X Butterfly Nut |
| S |  | 24+1X Flat Washer |
| T |  | 34+1X Bolt &8*18mm |
| U |  | 2+1X Bolt &8*80mm |
| V |  | 20+1X Bolt &8*60mm |
| W |  | 1 X Alley Key |

TOOLS REQUIRED:  SCISSORS (NOT INCLUDED)

COMPONENTS

BOX1

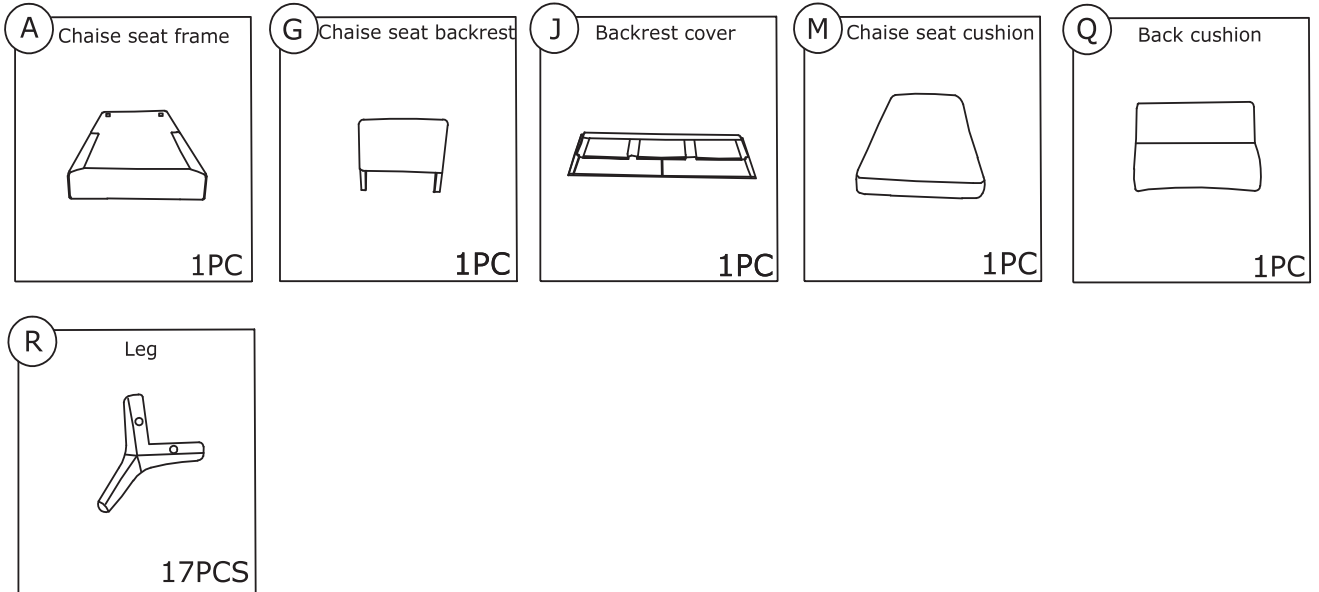

BOX2

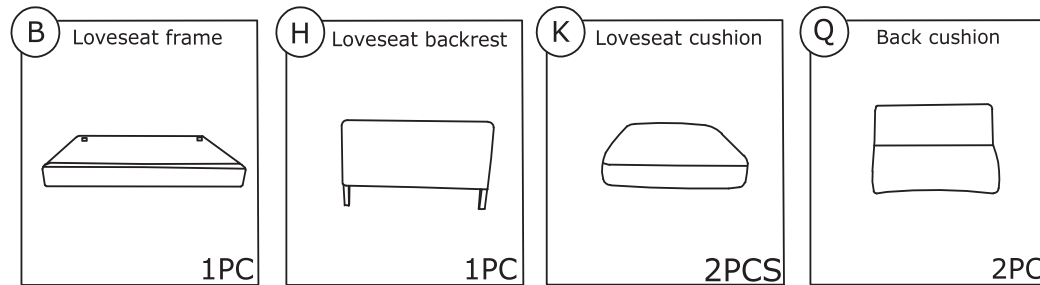

BOX3

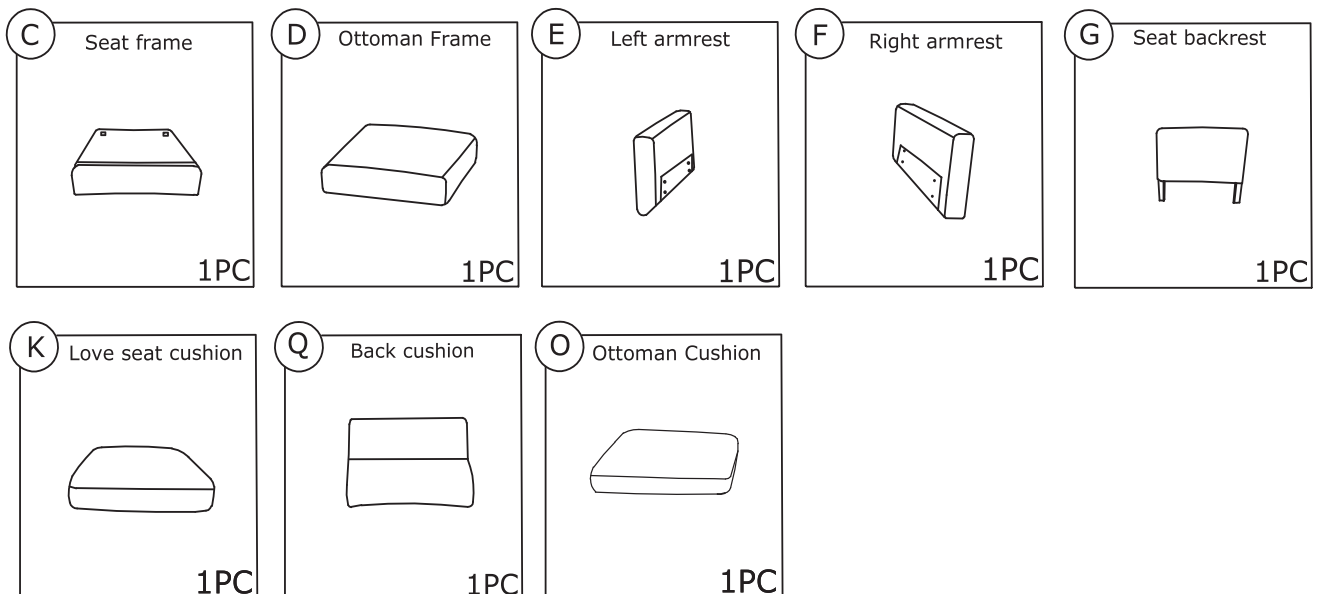

ASSEMBLY STEPS

STEP 1 Assemble the left armrest (E) to the chaise seat frame (A) with gaskets (S) and bolts (V).

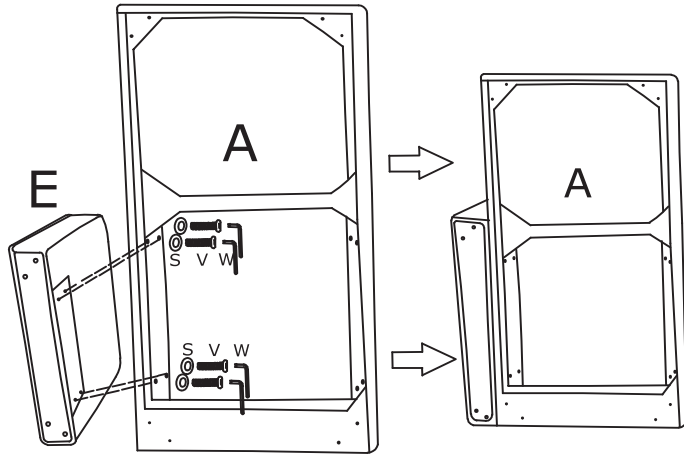
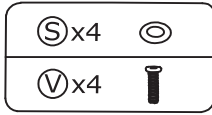

STEP 2 Assemble the right armrest (F) to the seat frame (C) with gaskets (S) and bolts (V).

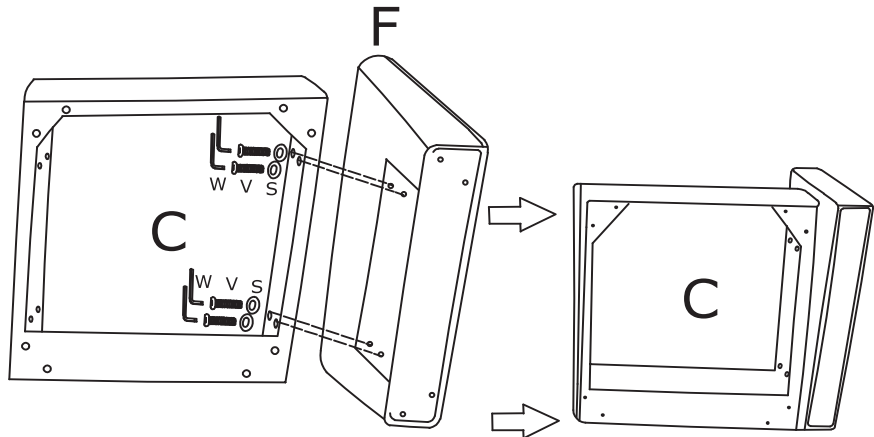
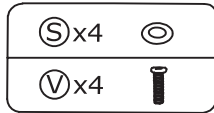

STEP 3 Assemble the love seat frame (B) to the chaise seat frame (A) and seat frame (C) with butterfly nuts (X) gaskets (U) and bolts (W).

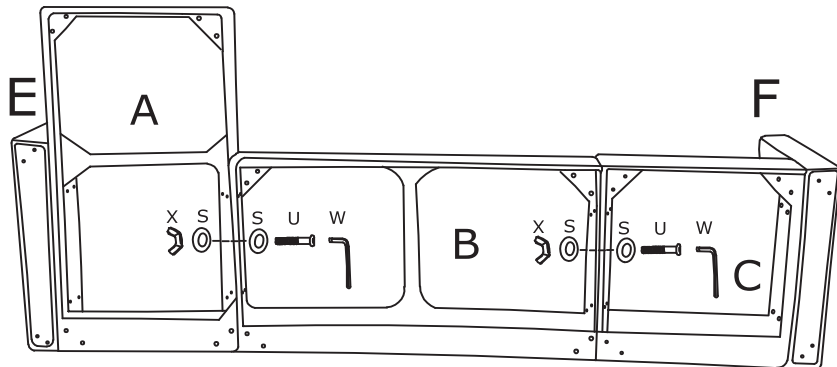
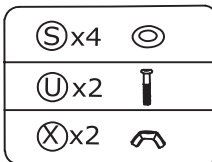

ASSEMBLY STEPS

STEP 4

Assemble the sofa legs(R)with bolts(T).

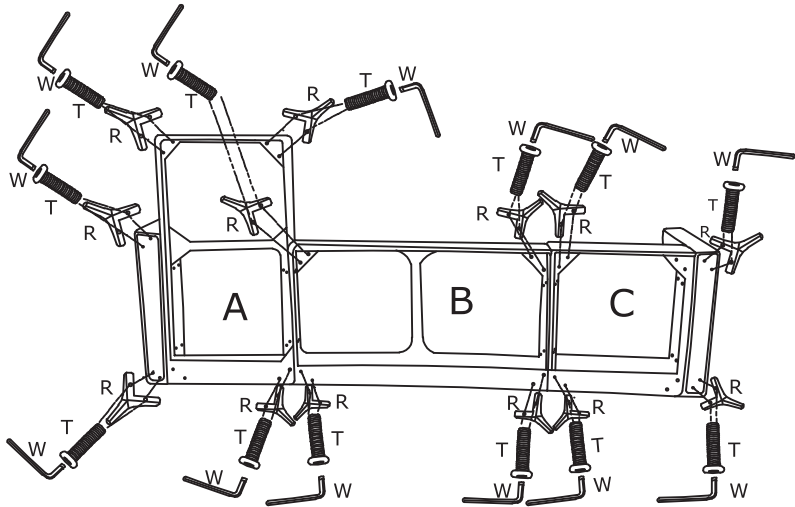

STEP 5

Assemble the legs(R)with bolts (T)to the ottoman.

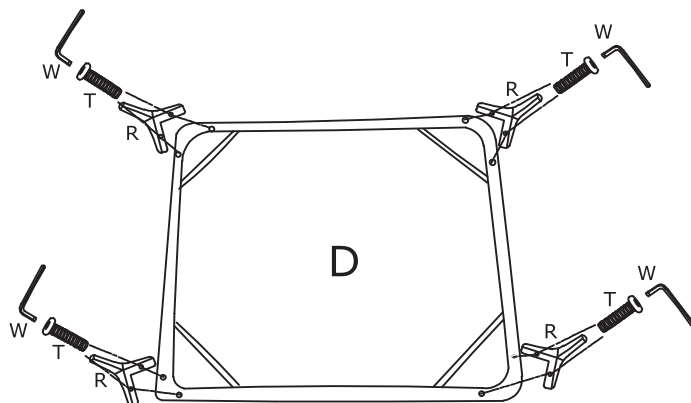
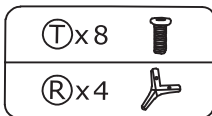

STEP 6

Insert the backrest (G), (H), (G) into the specified hole ,using gaskets(S)and bolts(V)to 70% tightness,and then tighten the all bolts on the seat.

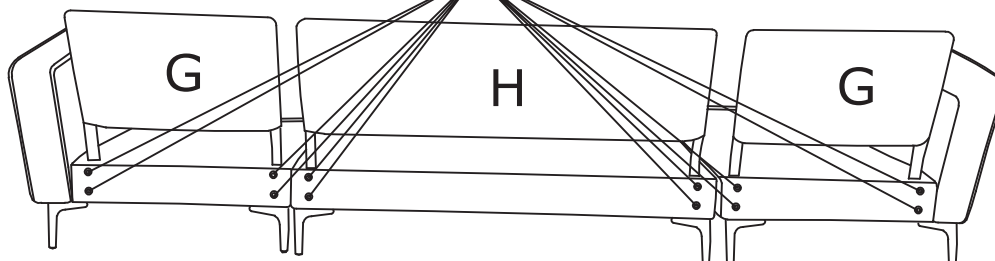
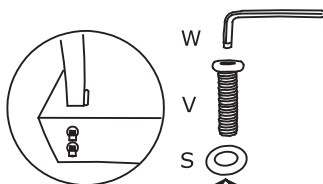
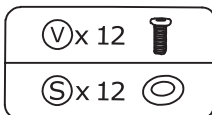

ASSEMBLY STEPS

STEP 7 Put the backrest cover (J) on the backrest frame.

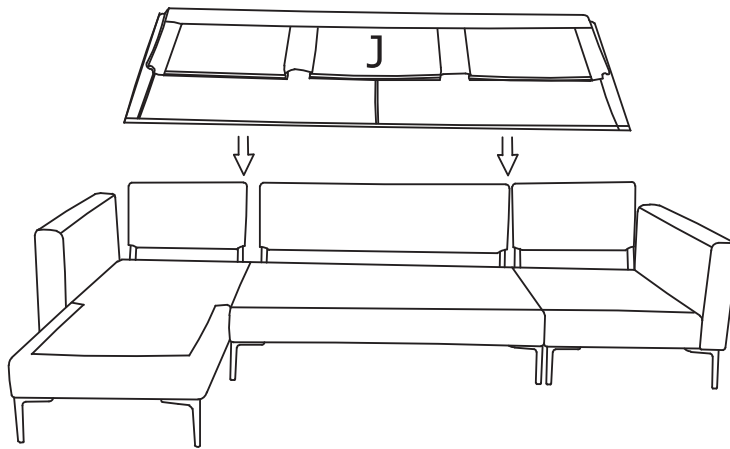

STEP 8 Velcro sticks to each other.

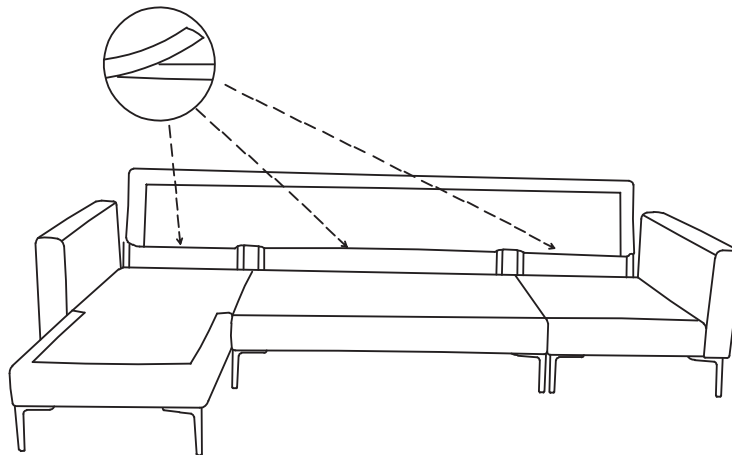

STEP 9 Use scissors to open all the vacuum sealed cushions and arm pillows. It may take 48-72hrs to fully expand back to its original shape.

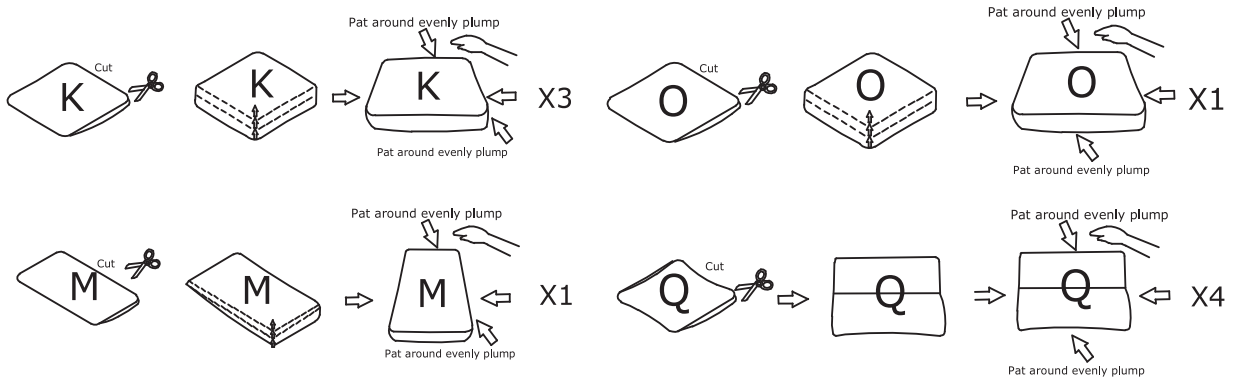

ASSEMBLY STEPS

STEP 10 Place five seat cushions on the sofa.

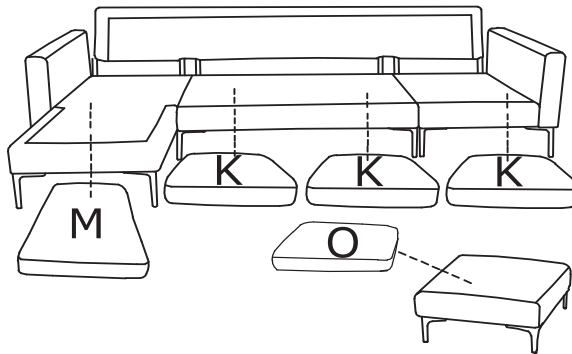

STEP 11 Please place back cushions on sofa and make sure it's will fitted.

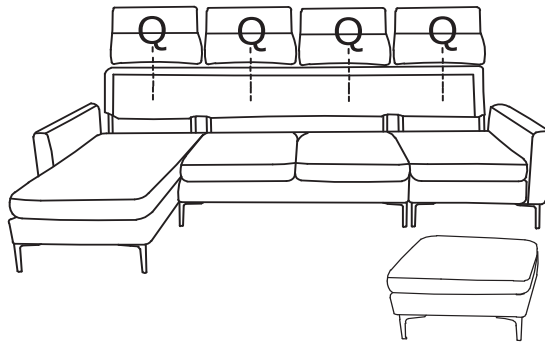

STEP 12 If the fabric has wrinkles, it will basically diappear after standing for 72 horus. Well done!! You can enjoy your leisure time on the sofa now.

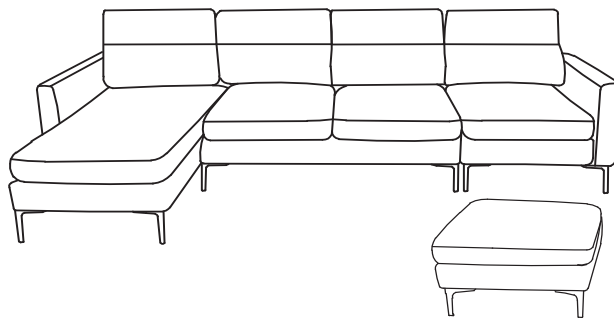

STEP 13 The chaise seat frame is interchangeable.

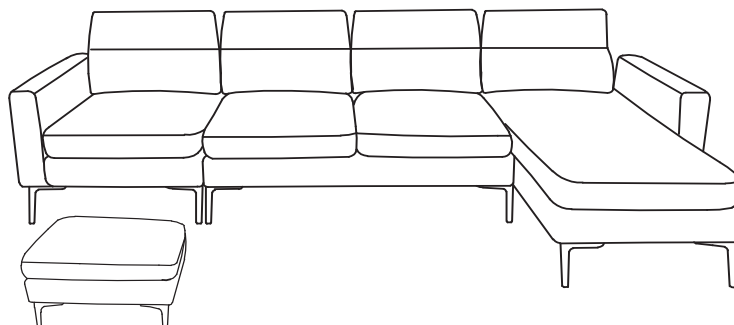

RETURN POLICY

We hope you enjoy your new furniture as much as we enjoyed making it, if you have any comments or suggestions about our product, please feel free to share with us.

We do our best to ensure your furniture arrives without any problems, but occasionally mistakes happen—as humans we are imperfect beings. In the event that a part is damaged or missing, we really don't want you to go through the hassle of re-packaging your item and sending it back, we will be more than happy to provide you with replacement part(s) for free.

All your concerns will be taken good care of by our CUSTOMER SERVICE TEAM.

All returns must be shipped back in original boxes Pictures may be required for some returns to ensure an item is not damaged prior to its return.

Items received without original boxes may not be accepted or may increase your return processing time.



WARNING

Manufacturer and seller expressly disclaim any and all liability for personal injury, property damage or loss, whether direct, indirect, or incidental, resulting from the incorrect attachment, improper use, inadequate maintenance, unapproved modification, or neglect of this product.