

ASSEMBLY INSTRUCTIONS

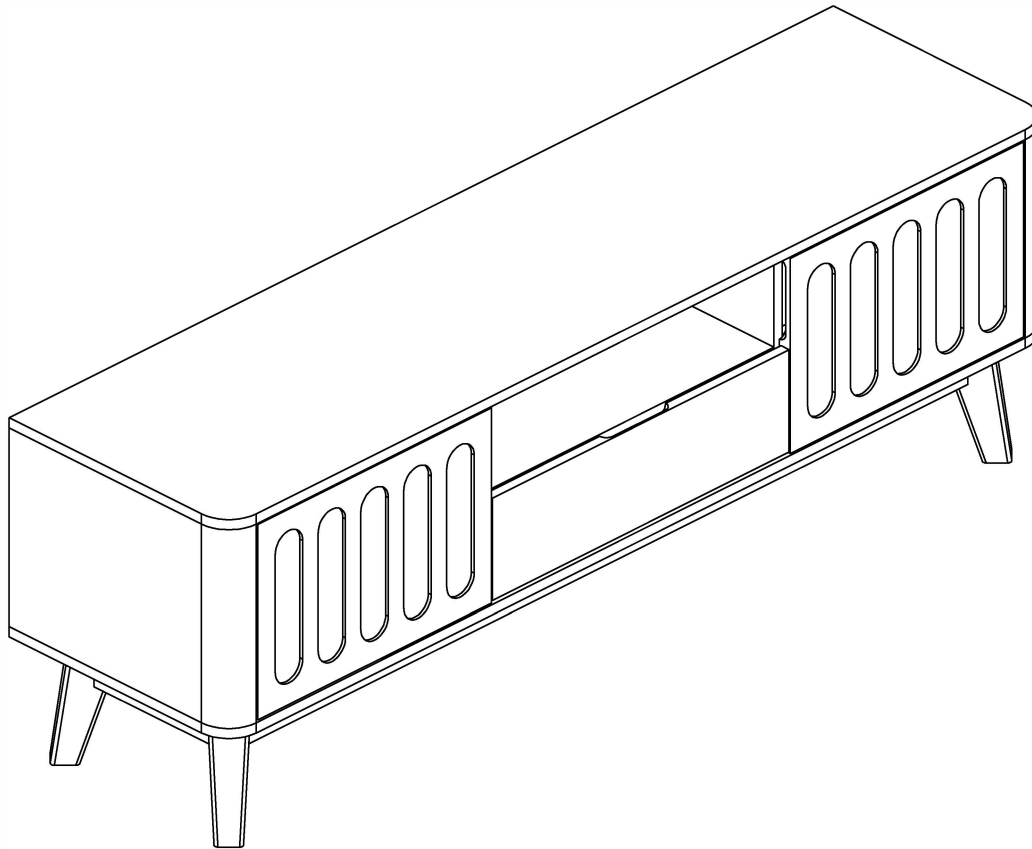

Notice:

1. Follow the installation instructions. Please confirm all accessories are preset before installation.
2. Do not fully tighten the screws during initial assembly. Fully tighten screws only once all pieces which are correctly assembled.
3. If you encounter any problems during installation, please contact our customer service.
4. Please unbox the item from the side with an open-label and put a carpet on the floor to avoid scratching it.

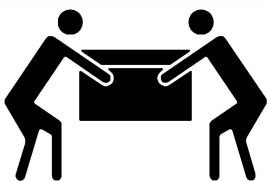

Recommended installers:2

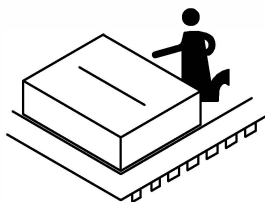



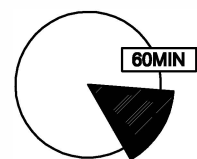





**Put a carpet on the floor
before unpacking**

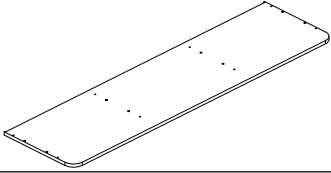

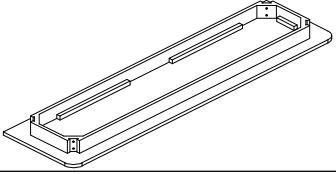
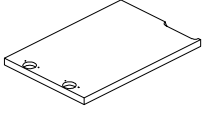
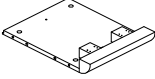
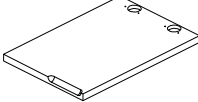
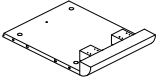
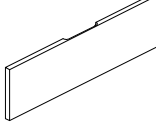
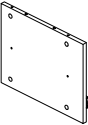
**Estimate installation time:
60minutes**

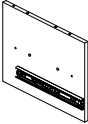

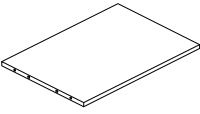

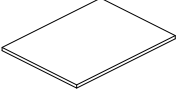
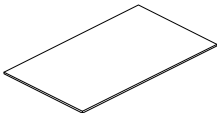
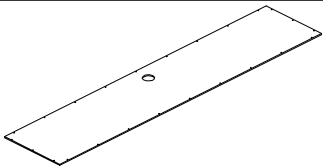
ASSEMBLY INSTRUCTIONS

PART LIST

Item no.	Reference Image	Qty	Item no.	Reference Image	Qty
(A)		X1	(J)		X4
(B)		X1	(K)		X1
(C)		X1	(L)		X1
(D)		X1	(M)		X1
(E)		X1	(N)		X1
(F)		X1	(O)		X1
(G)		X1	(P)		X1
(H)		X2	(Q)		X1
(I)		X1			

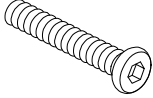
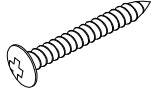
ASSEMBLY INSTRUCTIONS

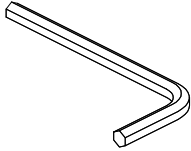
HARDWARE LIST

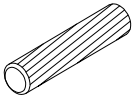
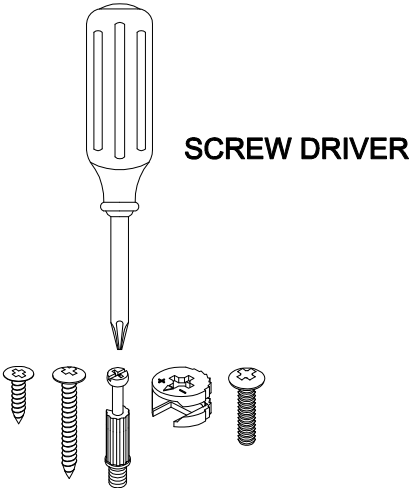
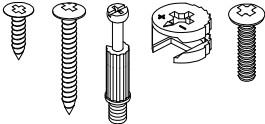
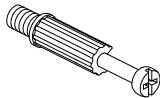
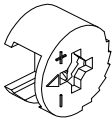
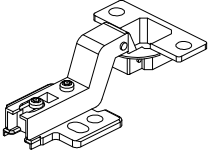
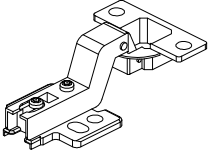
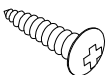
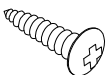
Item no.	Reference Image	Qty	Item no.	Reference Image	Qty
1	 Ø1/4"x2"	X8	11	 Ø7xØ3.5x30 mm	X8
2		X8	12		X1
3		X8			
4		X20+2	<p>The following tools are needed. But not included.</p>  <p>SCREW DRIVER</p> 		
5		X20+2			
6		X20+2			
7		X8			
8		X4			
9	 Ø6.5xØ3x14 mm	X24+2			
10	 Ø6.5xØ3x15 mm	X24+2			

ASSEMBLY INSTRUCTIONS

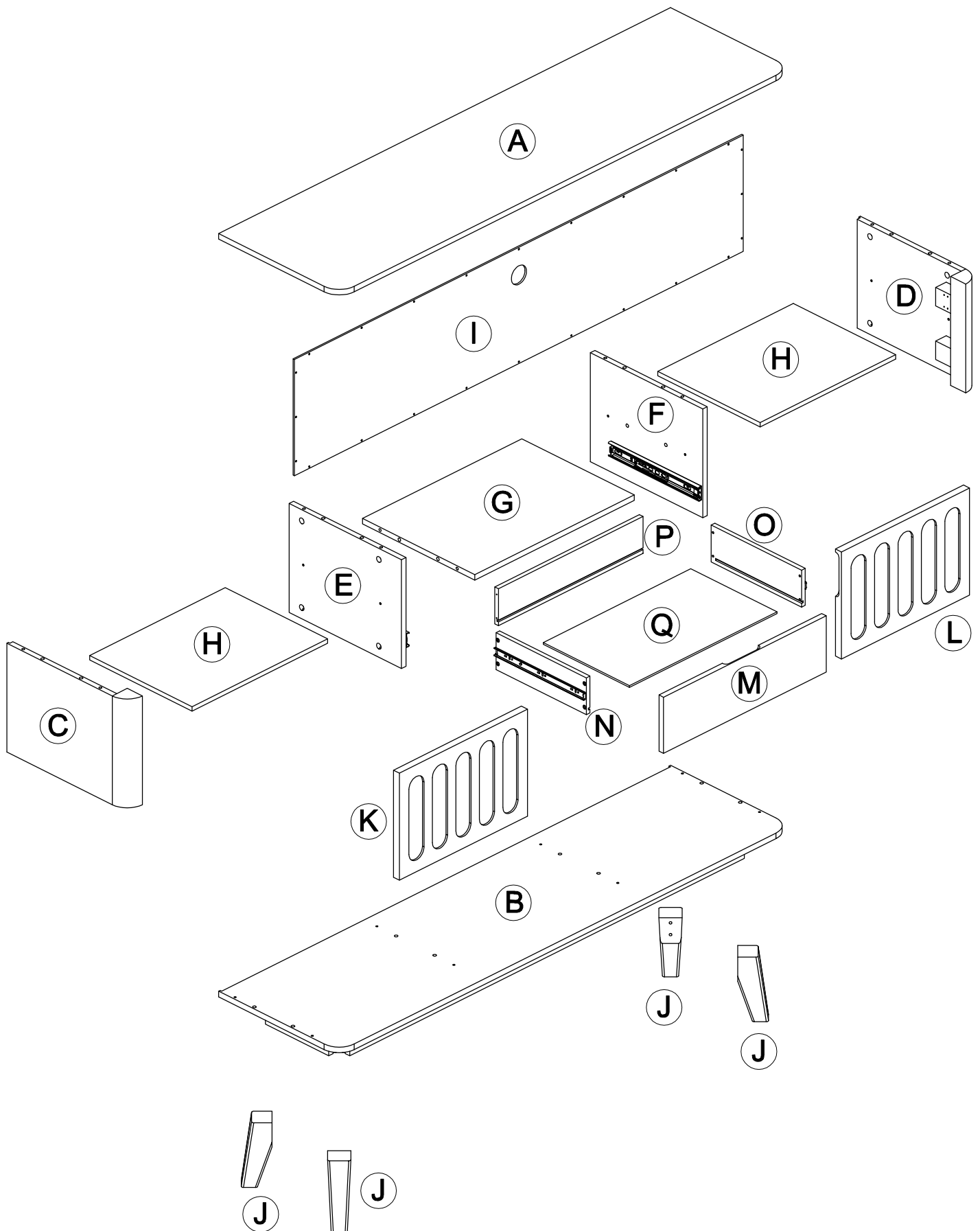

ASSEMBLY INSTRUCTIONS

1

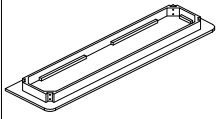

ⓑ 1pc



ⓐ 4pc

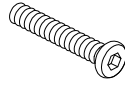

① 8pc



② 8pc



③ 8pc

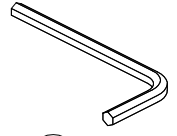

⑫ 1pc

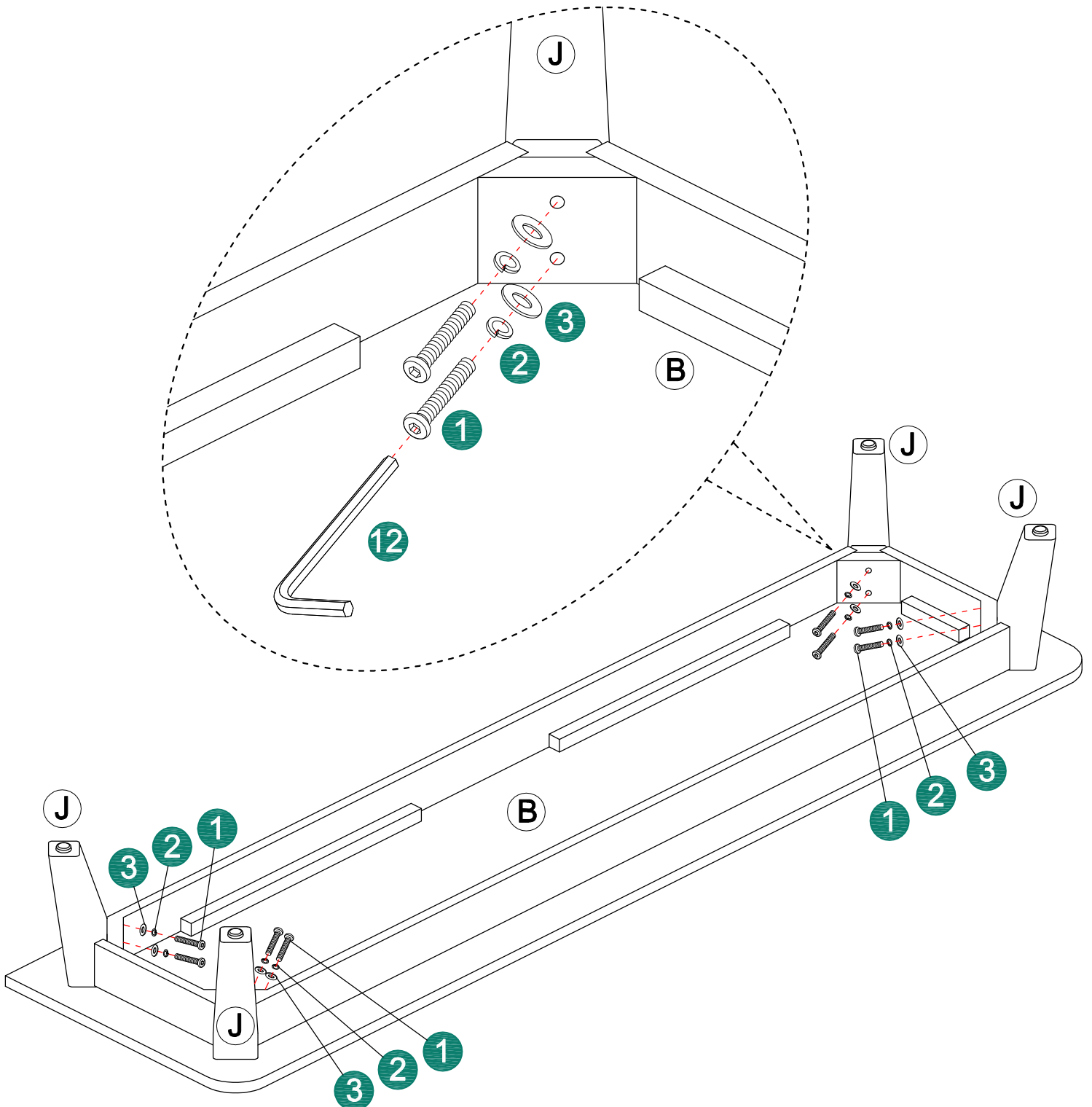

ASSEMBLY INSTRUCTIONS

2

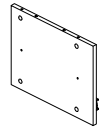

E 1pc

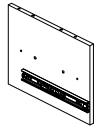

F 1pc

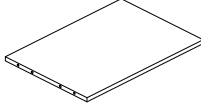

G 1pc

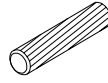

4 4pc

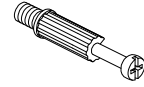

5 4pc



6 4pc

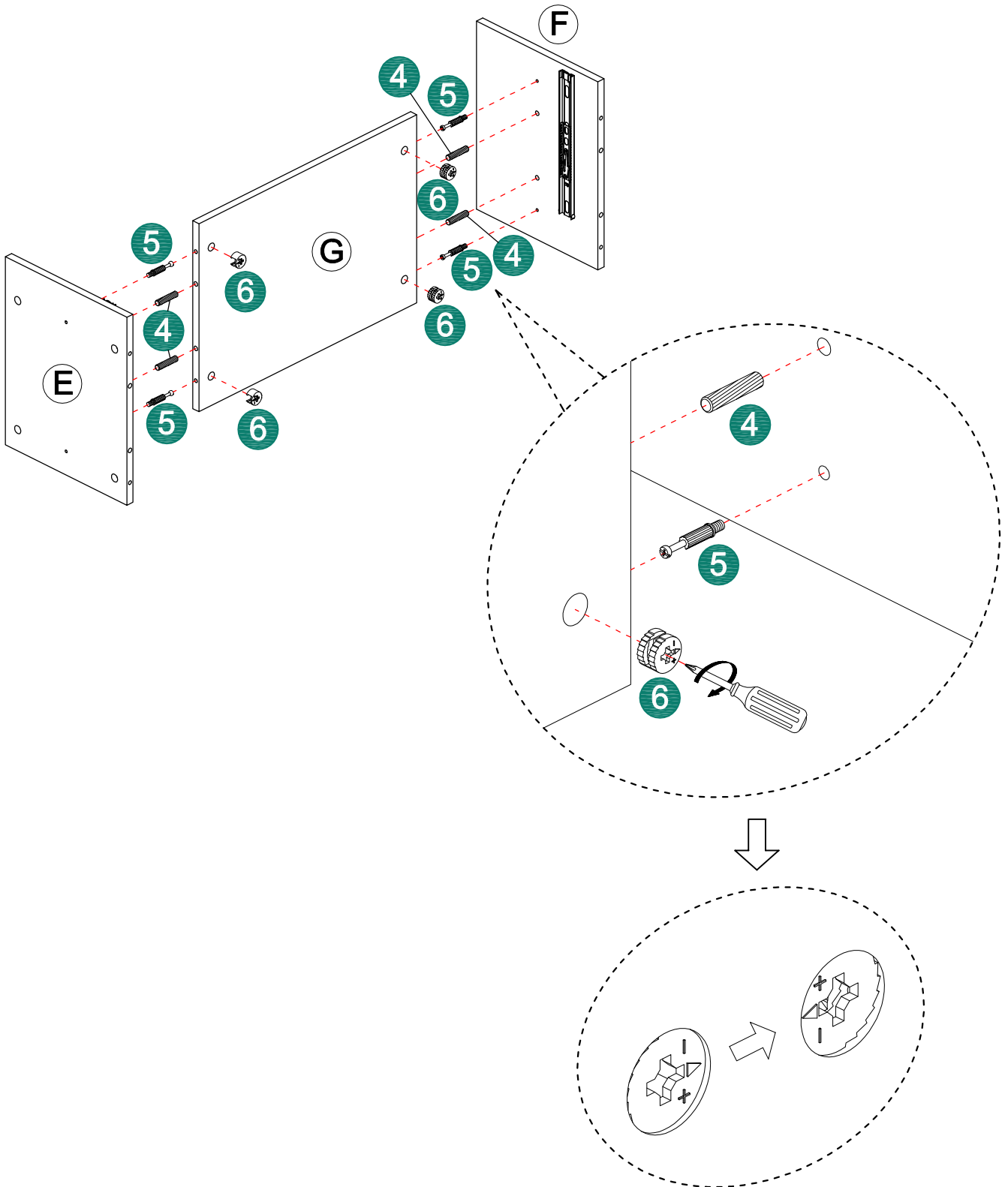

ASSEMBLY INSTRUCTIONS

3

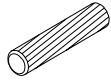

4 4pc

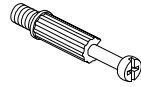

5 4pc



6 4pc

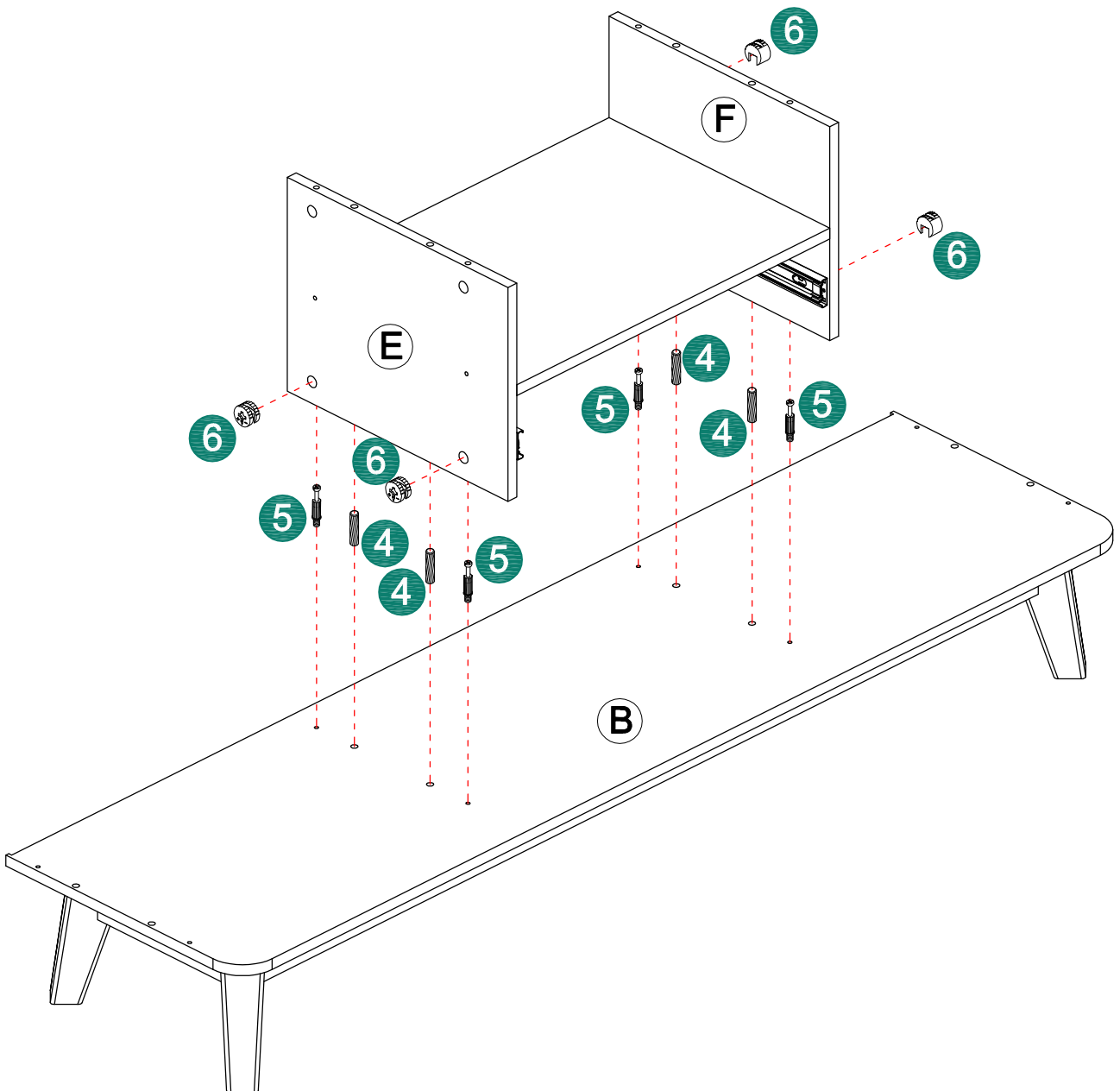

ASSEMBLY INSTRUCTIONS

4

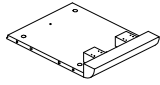

C 1pc

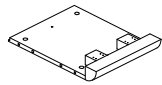

D 1pc

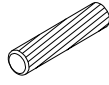

4 4pc

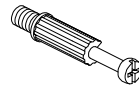

5 4pc



6 4pc

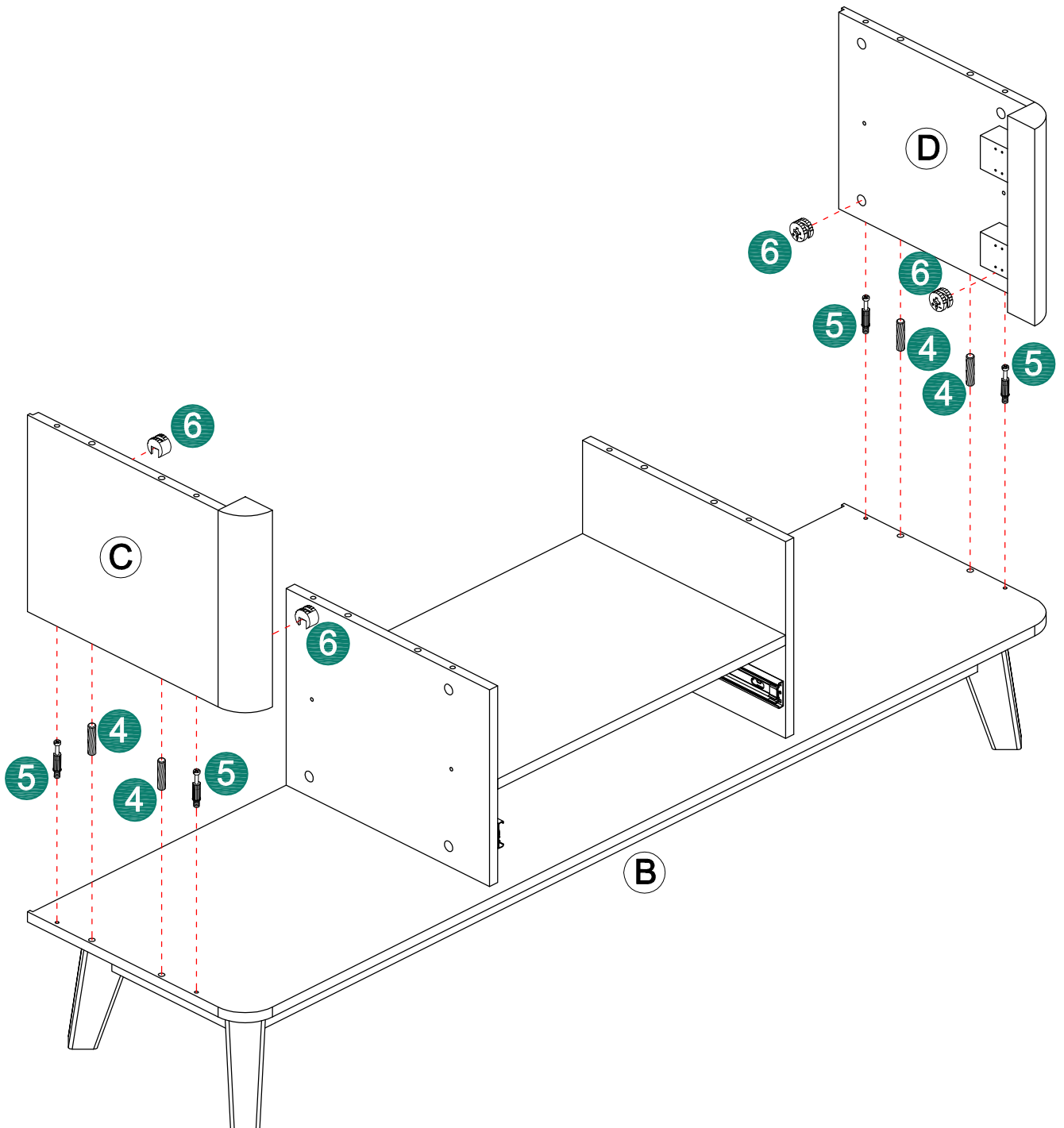

ASSEMBLY INSTRUCTIONS

6

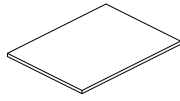

(H) 2pc



(7) 8pc

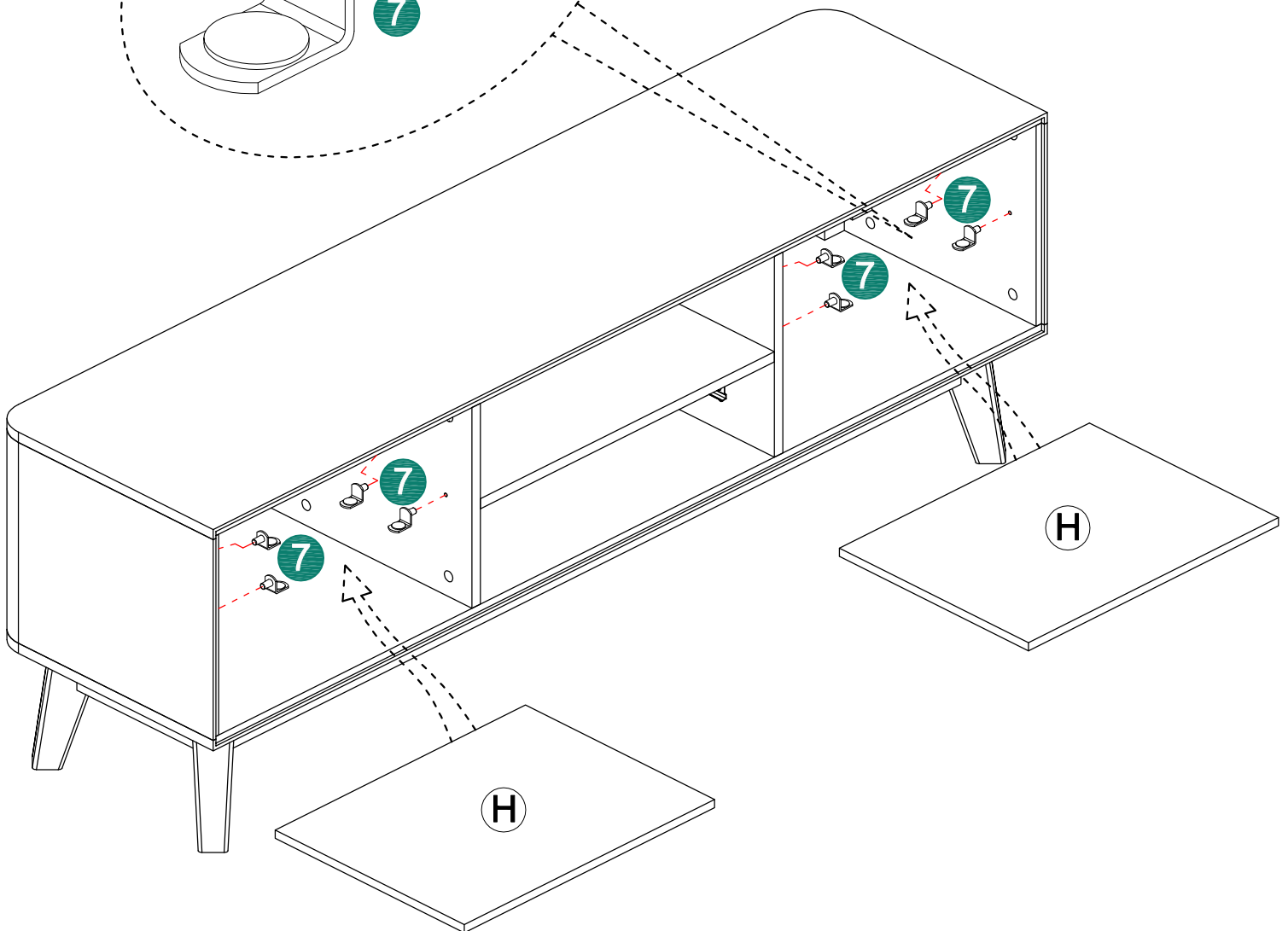
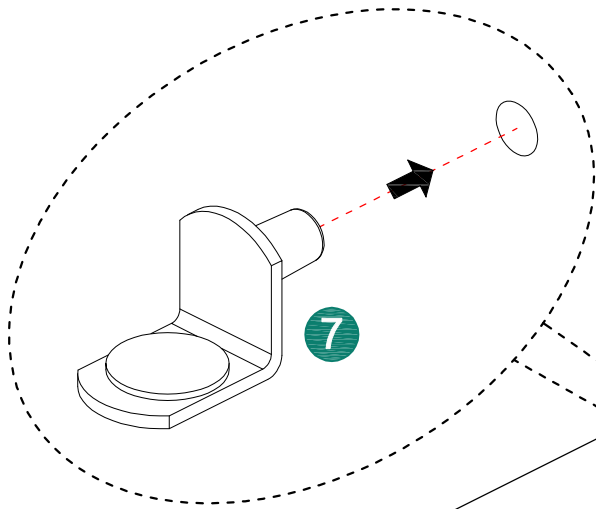

ASSEMBLY INSTRUCTIONS

7

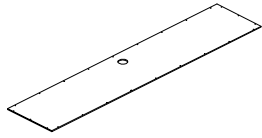

1 1pc



10 24pc

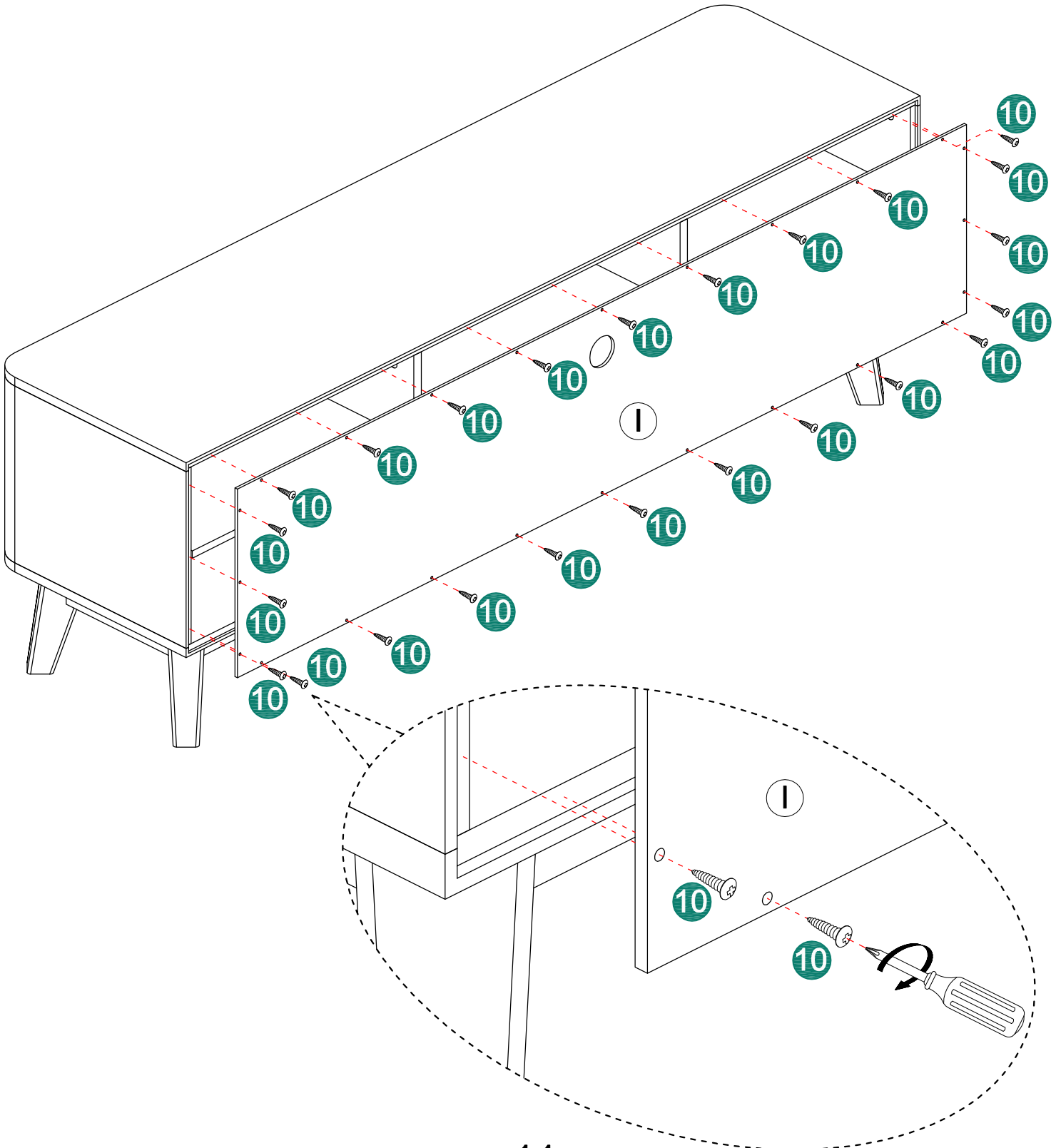

ASSEMBLY INSTRUCTIONS

8

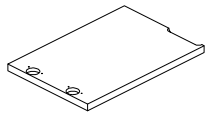

K 1pc

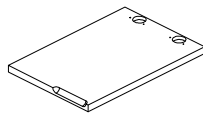

L 1pc

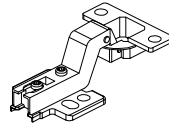

8 4pc



9 24pc

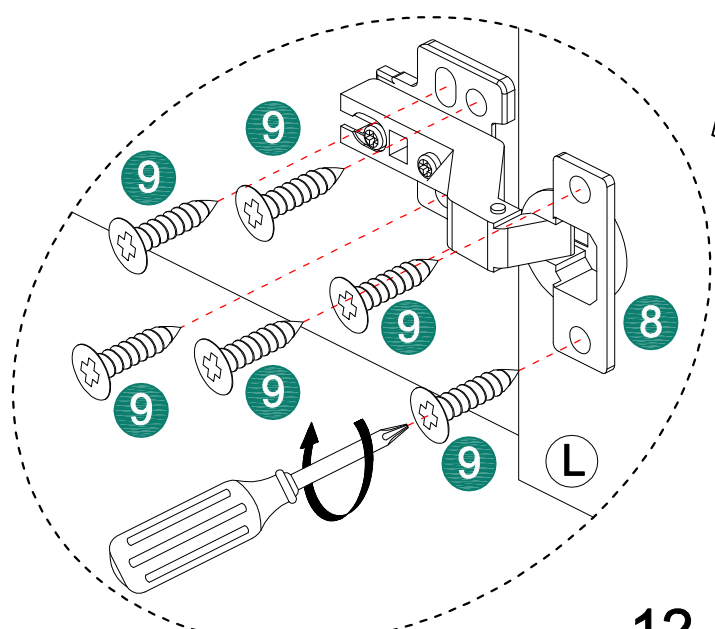
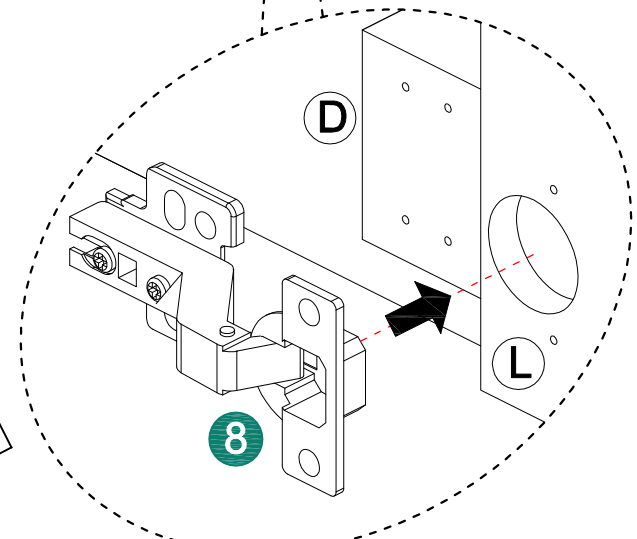
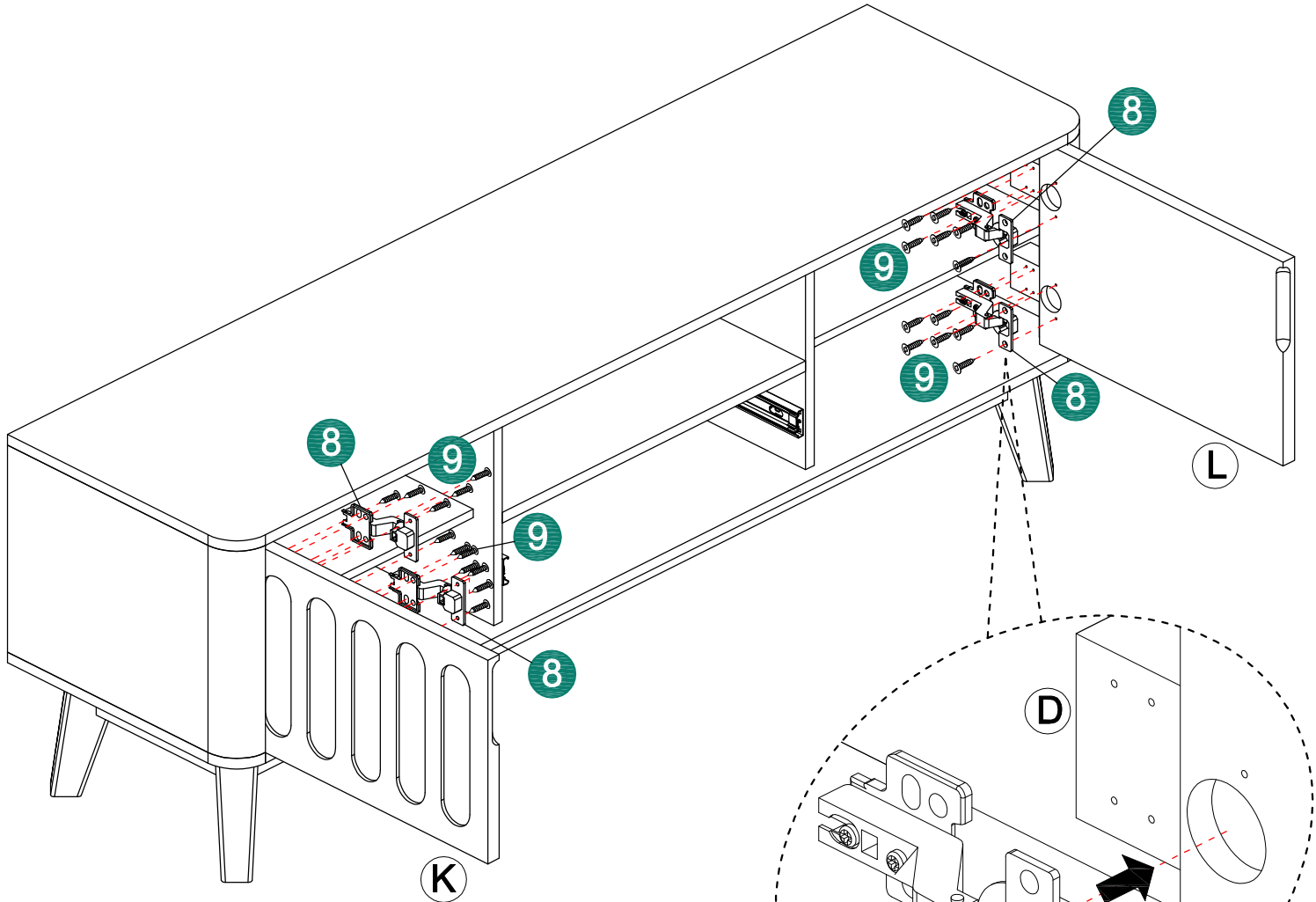

ASSEMBLY INSTRUCTIONS

9

FRONT VIEW

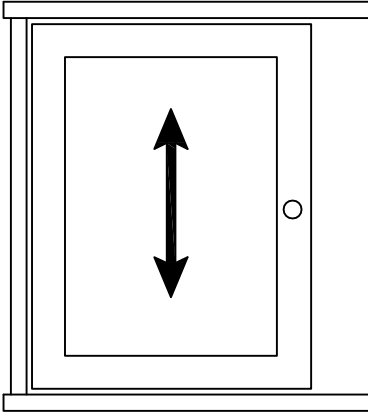

UP AND DOWN
Use screws to adjust the gaps
at the top and bottom of door.

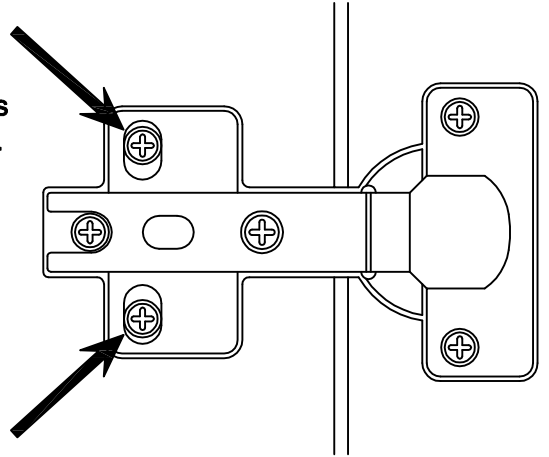

FRONT VIEW

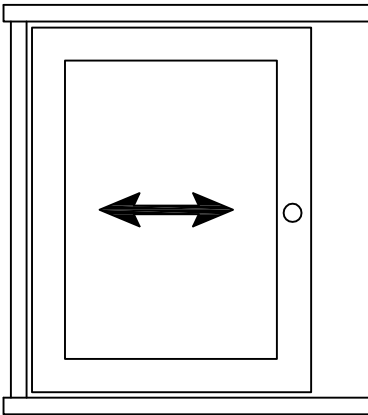

LEFT AND RIGHT
Use screw to adjust the gaps
at left and right of the door.

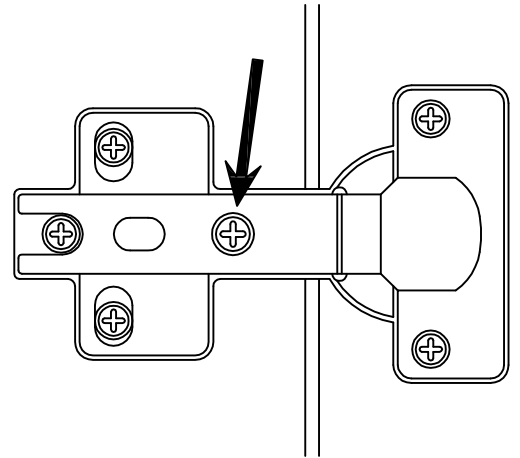

TOP VIEW

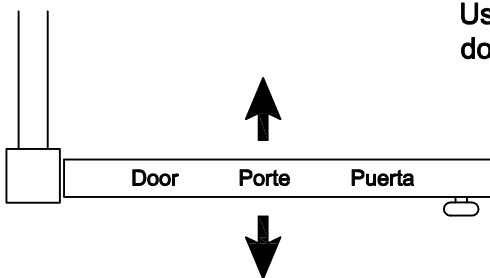



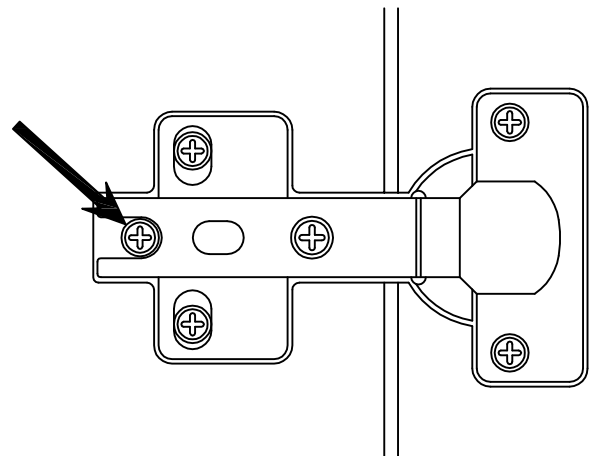

IN AND OUT
Use screw to move the
door in or out.



ASSEMBLY INSTRUCTIONS

10

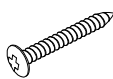
-  N 1pc
-  O 1pc
-  P 1pc
-  Q 1pc
-  11 4pc

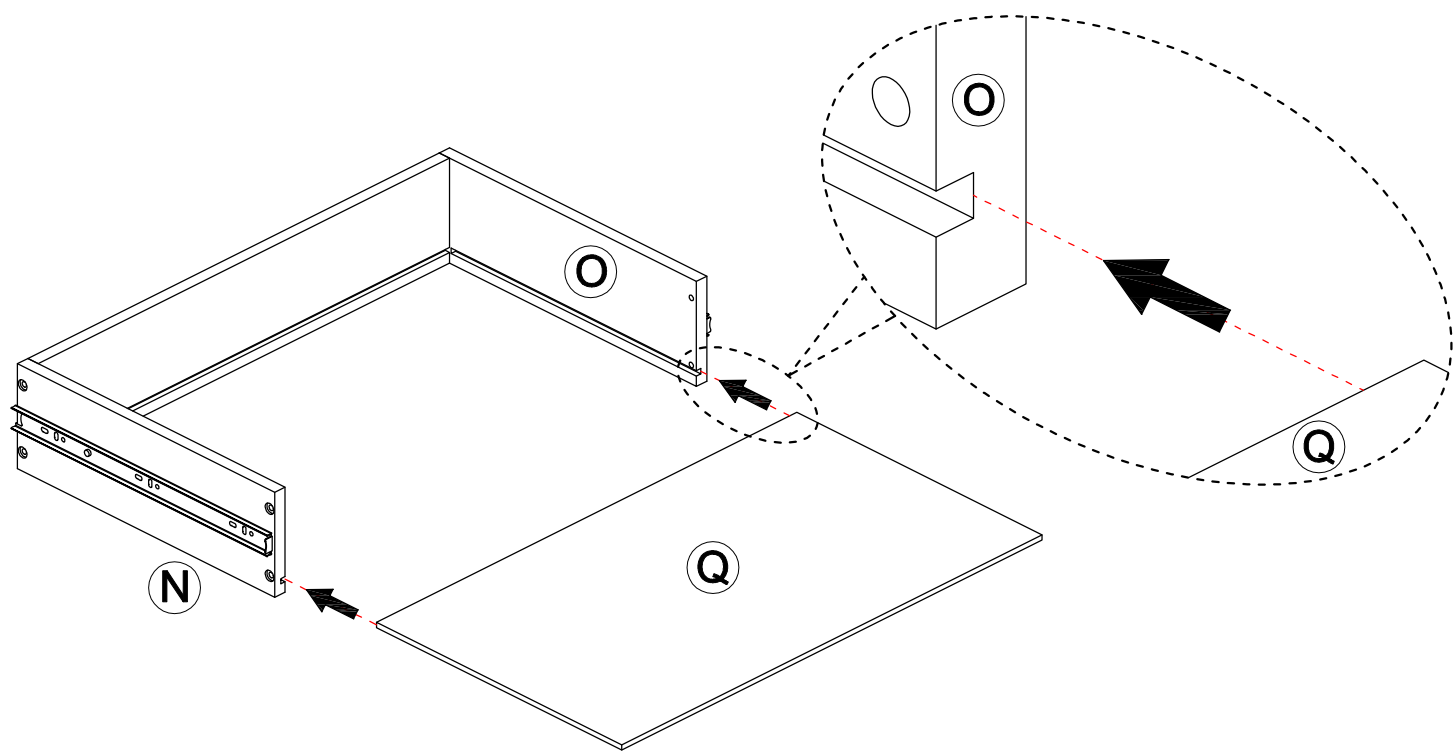
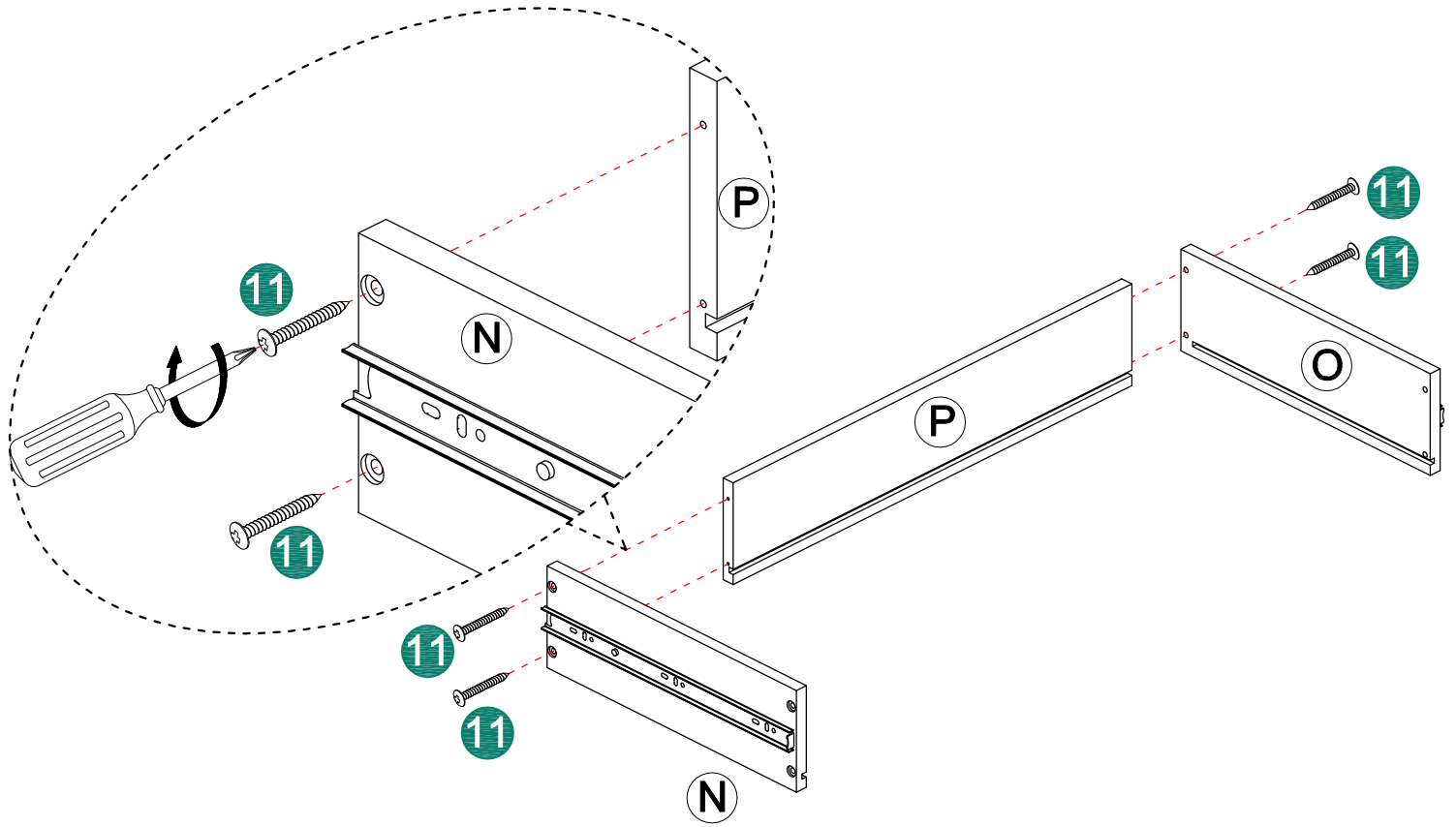

ASSEMBLY INSTRUCTIONS

11

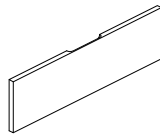

M 1pc

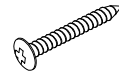

11 4pc

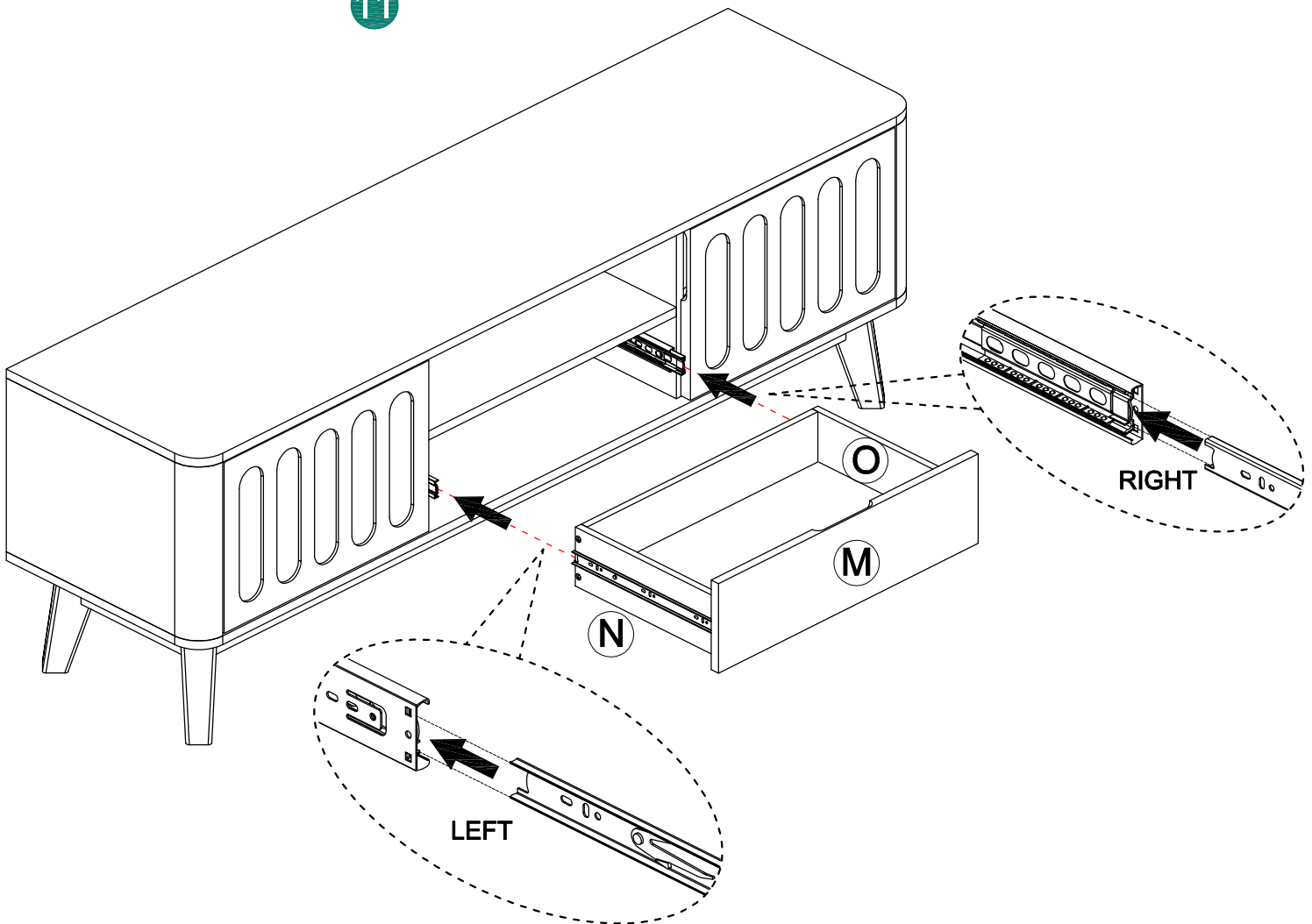
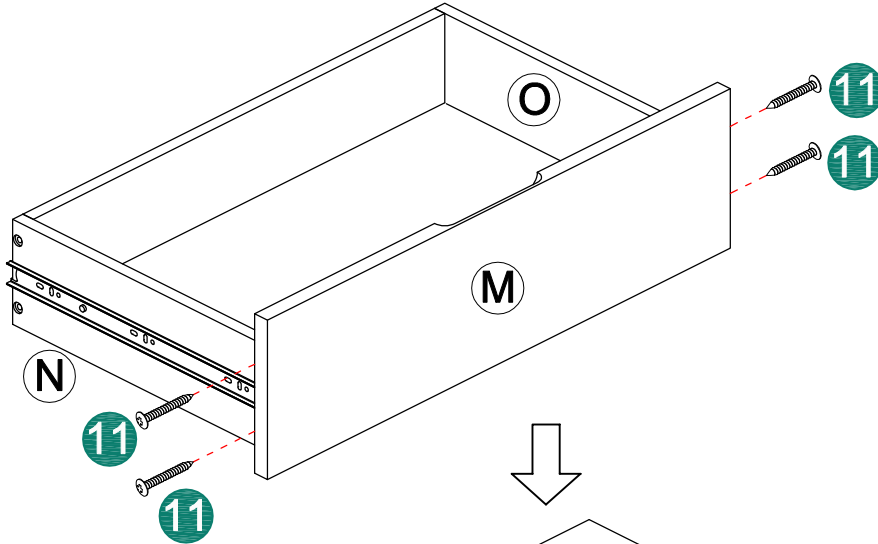

ASSEMBLY INSTRUCTIONS

12

