

ELECTRIC BASKET FIRE

INSTRUCTION MANUAL

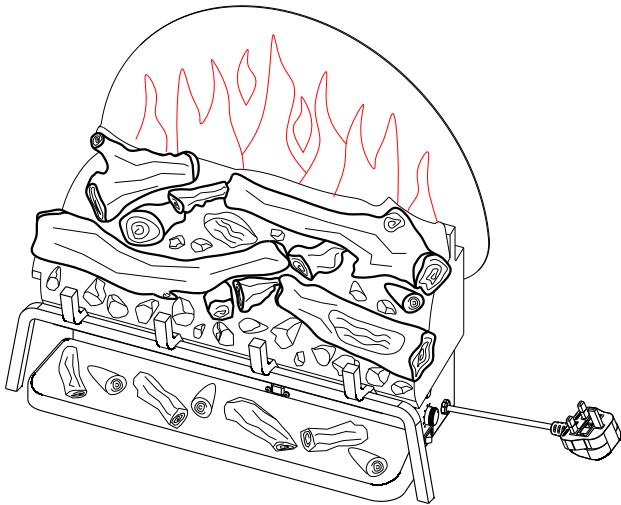

PLEASE READ THE INSTRUCTIONS CAREFULLY BEFORE
INSTALLING AND USING APPLIANCE.

SAVE THIS INSTRUCTION MANUAL FOR FUTURE REFERENCE.

IMPORTANT SAFETY INFORMATION

- Read all of the instructions before using this appliance.
- For indoor use only. This appliance is not suitable for use outside the house and only suitable for well insulated spaces or occasional use.
- DO NOT use this appliance in the immediate surroundings of a bath, a shower or a swimming pool.
- This fire must not be located immediately below or in front of a socket outlet. This appliance must be earthed.
- This appliance must not be supplied through an external switching device, such as a timer, or connected to a circuit that is regularly switched on and off by utility in order to avoid a hazard due to the inadvertent resetting of the thermal cut out.
- If the power cord is damaged, it must be repaired by the manufacturer, its authorized service centre or professional person.
-  The figure in the marking is “DO NOT COVER”

WARNING! in order to avoid overheating, do not allow the appliance to be covered or let the air inlet/outlet become obstructed.

- To reduce the risk of fire, keep textiles, curtains, or any other flammable material a minimum distance of 1 meter from the air outlet.
- Keep the power cord away from hot surfaces and hot conditions. DO NOT route the power lead in front of the appliance.
- DO NOT use this fire in rooms that have explosive fumes in them (for example petrol), or if you are using solvents, glue, aerosol spray or flammable paints, as these may catch fire.
- This appliance can be used by children aged from 8 years and above and persons with reduced physical, sensory or mental capabilities

or lack of experience and knowledge if they have been given supervision or instruction concerning use of the appliance in a safe way and understand the hazards involved.

- Children and vulnerable people must be supervised at all times when using this appliance, as some parts can become very hot and cause burns.
- Children aged between 3 and 8 years old should only switch on/off the appliance provided that it has been placed or installed in its intended normal operating position and instructions and supervision concerning the safe usage of the appliance are given.
- Cleaning and user maintenance shall not be made by children without supervision.
- This appliance shall not be played with by children.
- Children of less than 3 years should be kept away unless continuously supervised.
- Keep the power plug accessible after installation.
- DO NOT use if there are visible signs of damage to the appliance.
- DO NOT use this heater if it has been dropped.

WARNING! Informa on below for authorized person or service centre only:

A non-rewireable plug fitted with a 13A fuse is supplied. Should the fuse or plug need replacing, and you are competent to do so , it must be replaced with a 13A fuse or plug being 13A approved.

TECHNICAL SPECIFICATIONS

Supply Voltage: AC 230-240V 50Hz

Maximum power consumption: 1.8-2KW

Power for flame and fuel bed effect: 3.2W

HEAT OUTPUT:

Nominal heat output (P_{nom}): 2KW

Minimum heat output (indicated) (P_{min}): 1KW

Maximum continuous heat output (P_{max}): 2KW

TYPE OF HEAT OUTPUT/ROOM TEMPERATURE CONTROL	
Single stage heat output and no room temperature control	NO
Two or more manual stages, no room temperature control	NO
With mechanical thermostat room temperature control	NO
With electronic room temperature control	YES
Electronic room temperature control plus day timer	NO
Electronic room temperature control plus week timer	NO
OTHER CONTROL OPTIONS	
Room temperature control, with presence detection	NO
Room temperature control, with open window detection	NO
With distance control option	NO
With adaptive start control	NO
With working time limitation	NO
With black bulb sensor	NO

APPLIANCE DIMENSIONS

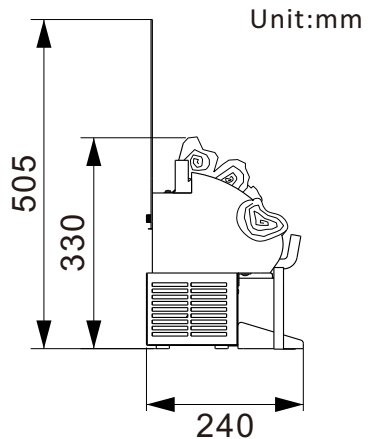
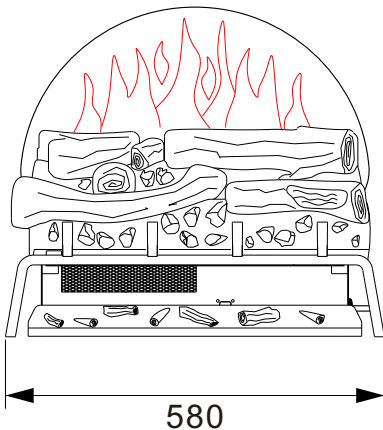





INSTALLATION INSTRUCTIONS

WARNING! DO NOT use this appliance if any part has been under water. Immediately call a qualified service technician to inspect and to replace any part of the electrical system if necessary.

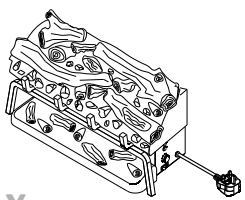
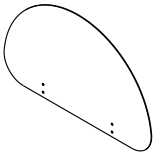
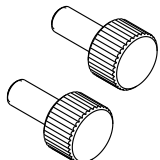
1. CHECK

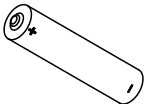
Please check that all the following parts are received without damages.

 1x	 1x	 2x
Firebox	Display Screen	Screw M5*12
 1x	 2x	 1x
Remote Handset	Battery	Instruction

2. INSTALL THE DISPLAY SCREEN

Fix the display screen to the back of firebox by using 2 flat head screws. You can lower the height of the screen by fixing it through the top holes.

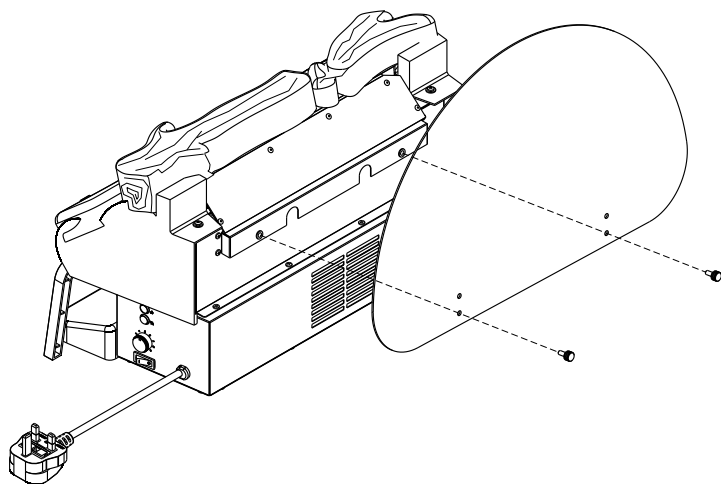

3. INSERT INTO THE OPENING

This unit does not require any special venting. It is recommended to install the fire in an opening with the following minimum dimensions for best flame effect.

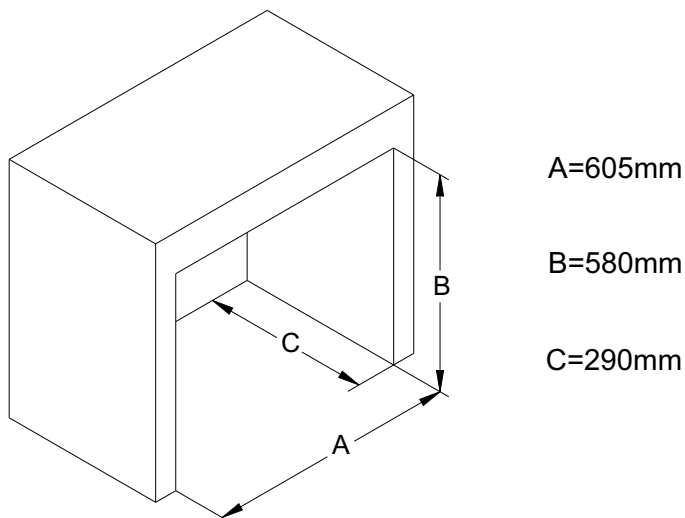

OPERATING INSTRUCTION





1. GENERAL

WARNING! Do not operate the appliance if it is damaged or has malfunctioned. If you suspect the appliance is damaged or has malfunctioned, call a qualified service engineer to inspect the appliance, and replace any part of the electrical system, if necessary, before reuse.

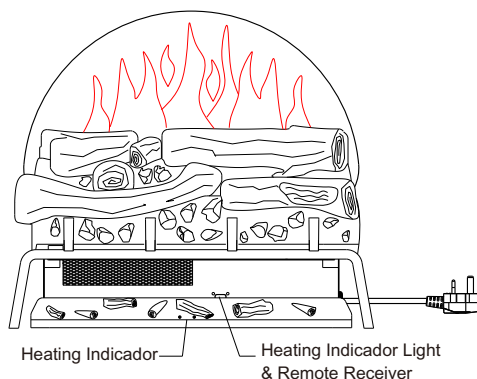
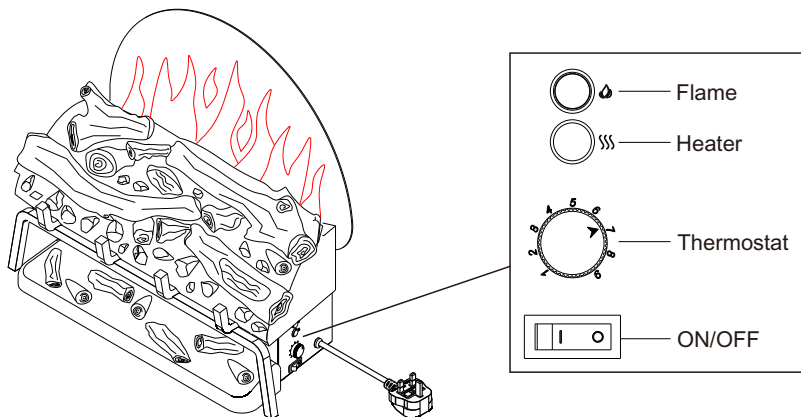
- MAKE SURE the plug fits right in the outlet. Faulty wall outlet connections or loose plugs can cause the outlet to overheat.
- The appliance can be operated manually or by remote control.

2. MANUAL CONTROL





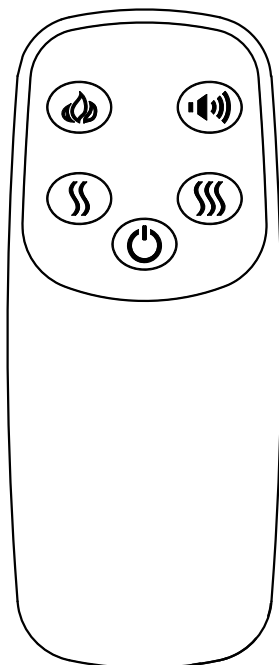

Button	Name	Function
	On/OFF Switch	<p>Turn on the appliance with the main switch at “I” position and a long beep sound will be heard.</p> <p>Note: The remote control will lost the memory for function settings when the switch is turned at OFF Position “O”.</p>
	Flame	<p>Repeatedly press to cycle from Flame A –Flame B – Flame C – Flame Off.</p> <p>Flame A: full bright flame + little blue Flame B: full bright flame Flame C: half bright flame</p>
	Heater	<p>Repeatedly press to cycle from Low–High–Off. The indicator light on the bottom of the firebox will illuminate when the heater is turned on. The indicator light will go out within 10s.</p> <p>Low: (●○) High: (●●)</p> <p>Note:</p> <ul style="list-style-type: none"> • Heater can be used without flame. • The heater will work when the temperature set by thermostat is higher than room temperature. • The fan works about 10s ahead of the heater, and stops about 10s later than the heater. • The indicator light in the lower fuel bed always illuminates when heater is on.
	Thermostat	<p>Turn it to setting 9 first and when the room has reached a desired level, turn the rotary switch counterclockwise slowly until the thermostat just ‘clicks’ off. The thermostat will then maintain the room at this selected level. To increase the temperature, turn the rotary switch clockwise to a higher setting.</p>

3. REMOTE CONTROL

- **NOTE:**
- Remote control can be used only when the main power switch is on. Aim the remote control at the remote receiver.



Button	Name	Function
	Power	Press to turn on the appliance or turn off and put it into standby mode with previous settings saved. For the first time use, Flame A will be turned on.
	Flame	Repeatedly press to cycle from Flame A –Flame B – Flame C – Flame Off.

Button	Name	Function
	Low Heat	Press to turn on the heater on half heat setting or turn off the heater.
	High Heat	Press to turn on the heater on full heat setting or turn off the heater.
	Crackling	Press to turn on the crackling and cycle through high crackling sound - normal crackling sound - low crackling sound - high crackling with wind sound - normal crackling with wind sound - low crackling with wind sound - sound off

Temperature Limiting Control

This heater is equipped with a Temperature Limiting Control. Should the heater reach an unsafe temperature, the heater will automatically turn off. To reset:

- Unplug the power cord from the outlet.
- Switch off the appliance via manual control panel. Wait at least 5 minutes.
- Inspect the fireplace to make sure no vents are blocked, or clogged with dust or lint. If they are, use a vacuum to clean the vent areas.
- With the power switch in the OFF position, plug the power cord back into the outlet.

If it switches off again, UNPLUG THE HEATER RIGHT AWAY! Have the outlets, wiring, and breaker box inspected by a professional. Make necessary repairs before using the heater.

CLEANING & MAINTENANCE

ALWAYS turn the heater **OFF** and unplug the power cord from the outlet before cleaning, performing maintenance, or moving this fireplace. Fail to do so could result in electric shock, fire, or personal injury.

CLEANING

NEVER immerse in water or spray with water, which could result in electric shock, fire, or personal injury.

The appliance should be occasionally cleaned using a dry cloth. Do not use detergents, abrasive cleaners or furniture polish.

To clean the appliance, use a lightly damp cloth and ensure any moisture is dried fully using a lint free cloth.

Ensure that the heater vent is kept dust free by occasionally vacuuming the area using a brush attachment.

WARNING! Abrasive cleaners should not be used on the glass panel. Liquids should not be sprayed directly onto any surface of the unit.

MAINTENANCE OF MOTORS

The motors used on the fan and flame effect are pre-lubricated for extended bearing life and require no further lubrication. Electrical components are integrated in the fireplace and are not serviceable by the consumer. However, periodic cleaning/vacuuming of the fan/heater unit is recommended.

Use only replacement parts supplied by the manufacturer. Use of any other parts, or modifying the fireplace in any way, will void all warranties.

No internal parts are replaceable or serviceable.