

ASSEMBLY INSTRUCTIONS

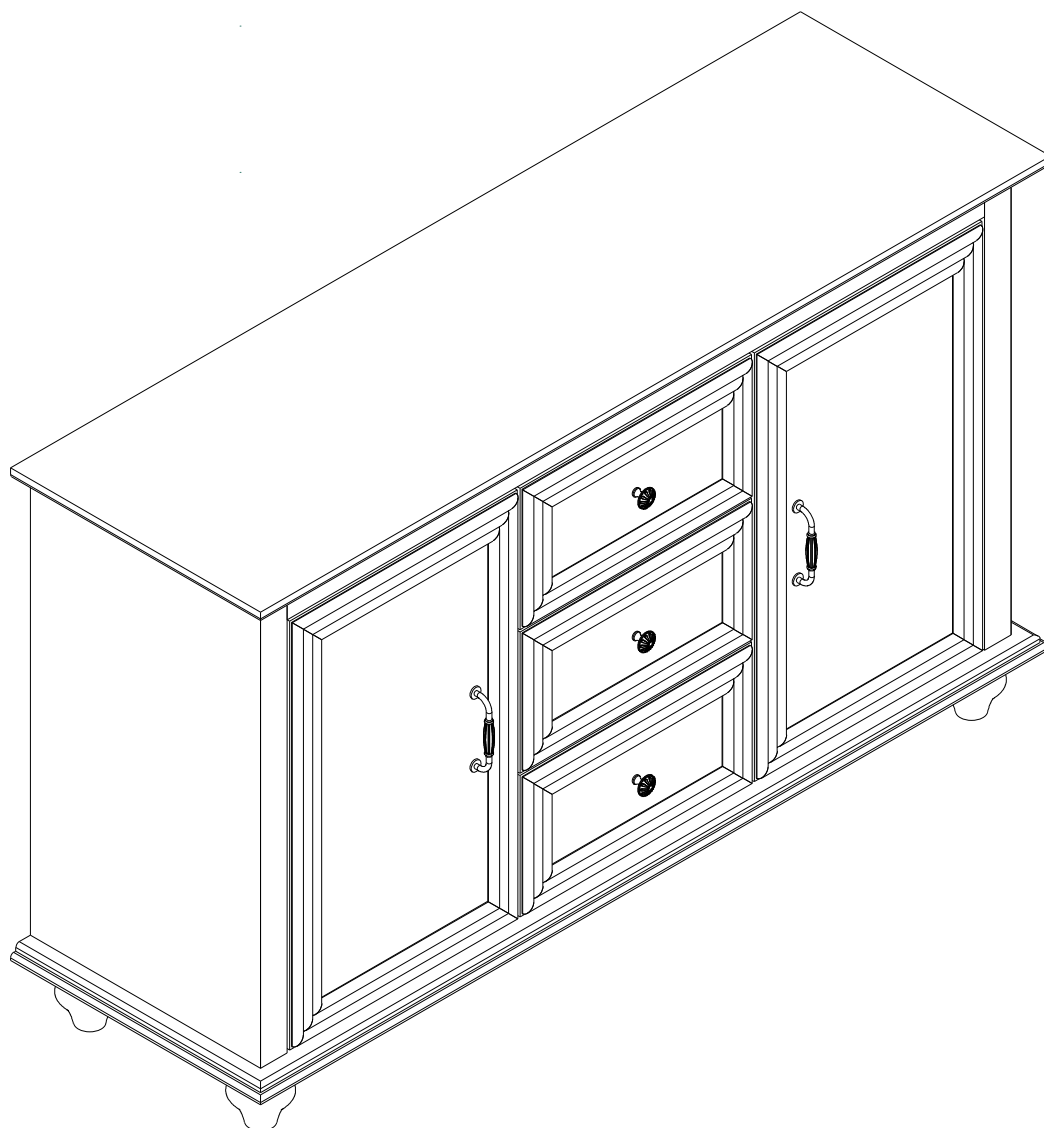

Notice:

1. Follow the installation instructions. Please confirm all accessories are preset before installation.
2. Do not fully tighten the screws during initial assembly. Fully tighten screws only once all pieces which are correctly assembled.
3. If you encounter any problems during installation, please contact our customer service.
4. Please unbox the item from the side with an open-label and put a carpet on the floor to avoid scratching it.

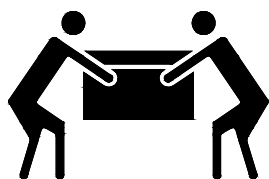

Recommended installers:2

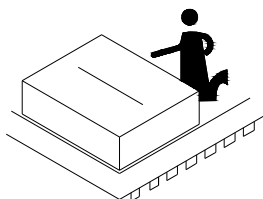

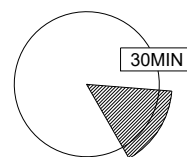

Put a carpet on the floor
before unpacking



Estimate installation time:
30minutes



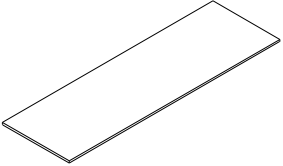
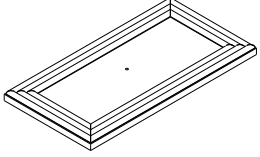
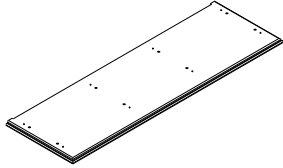
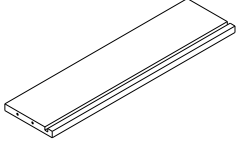
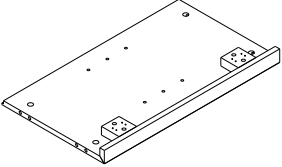
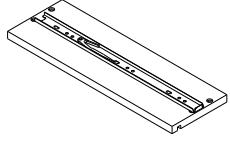
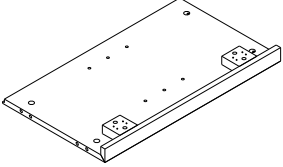
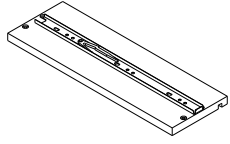
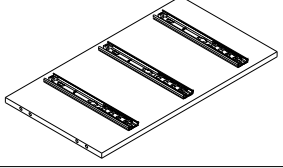
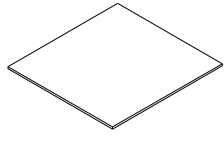
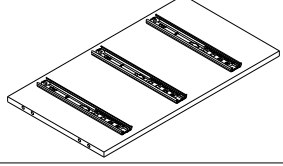
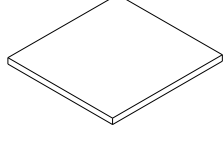
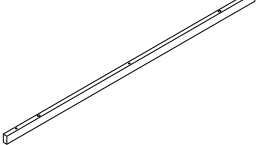
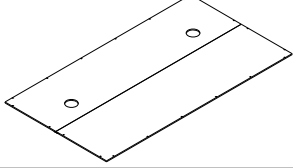
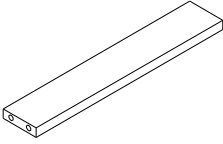

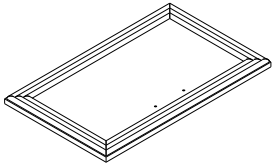

ASSEMBLY INSTRUCTIONS

PART LIST

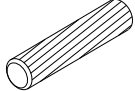
Item no.	Reference Image	Qty	Item no.	Reference Image	Qty
(A)		X1	(J)		X3
(B)		X1	(K)		X3
(C)		X1	(L)		X3
(D)		X1	(M)		X3
(E)		X1	(N)		X3
(F)		X1	(O)		X2
(G)		X1	(P)		X1
(H)		X2	(Q)		X4
(I)		X2			

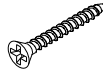
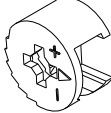
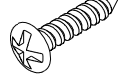
ASSEMBLY INSTRUCTIONS

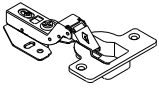
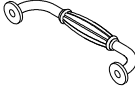
HARDWARE LIST

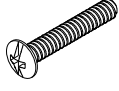
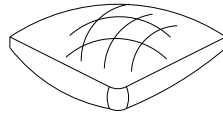
Item no.	Reference Image	Qty	Item no.	Reference Image	Qty
1	 Ø8*30mm	X22+2	7		X8
2		X20+2	8	 Ø3.5*30mm	X27+2
3		X20+2	9	 Ø3*15mm	X22+2
4		X3	10		X4
5		X2	11	 Ø3*14mm	X24+2
6	 Ø5*3/4"	X7	12		X2

ASSEMBLY INSTRUCTIONS

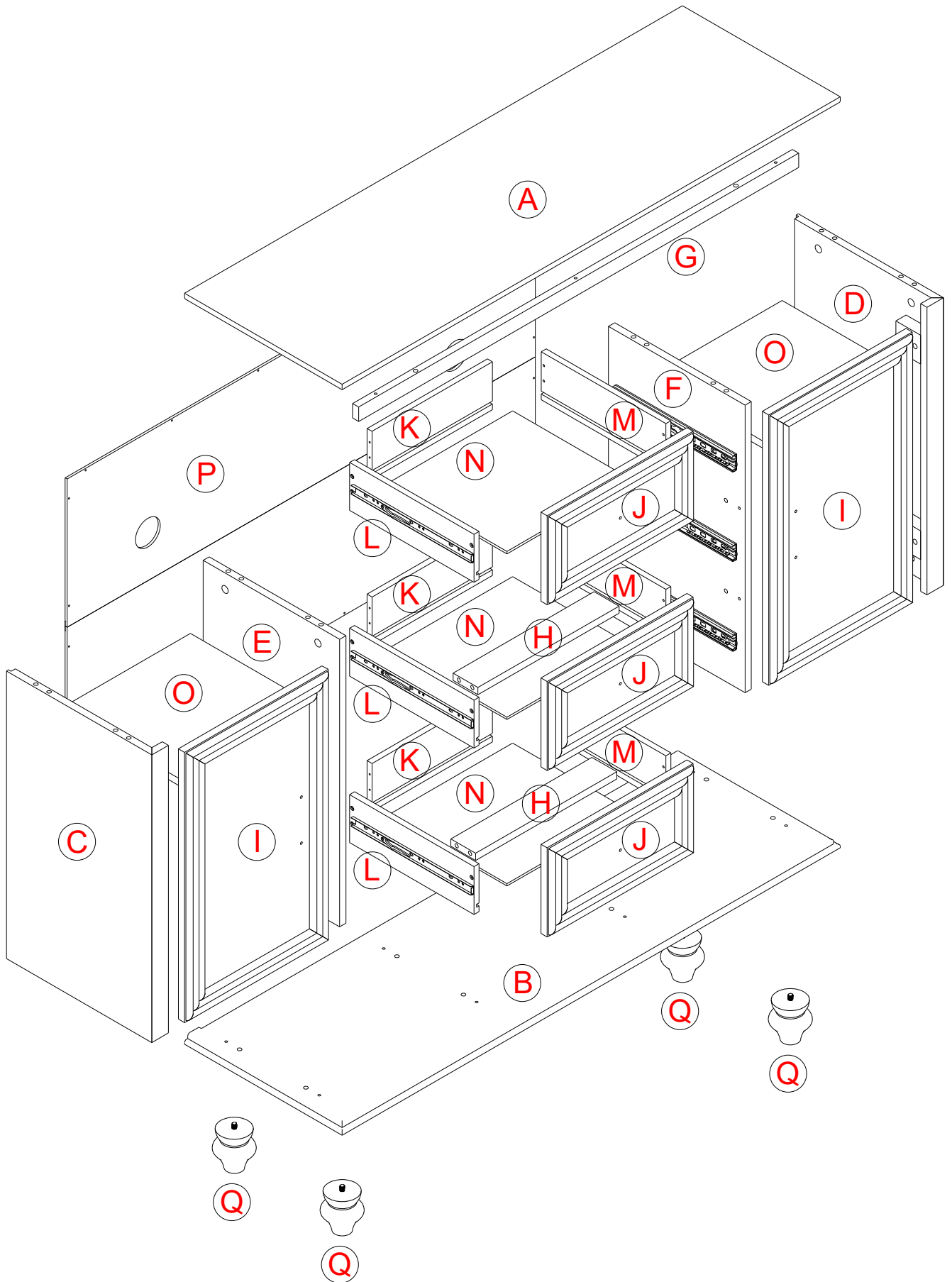

ASSEMBLY INSTRUCTIONS

1

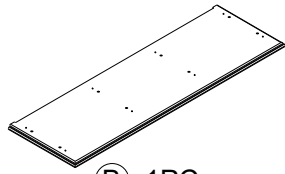

(B) 1PC

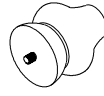

(Q) 4PC

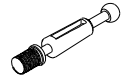

(2) 8PCS

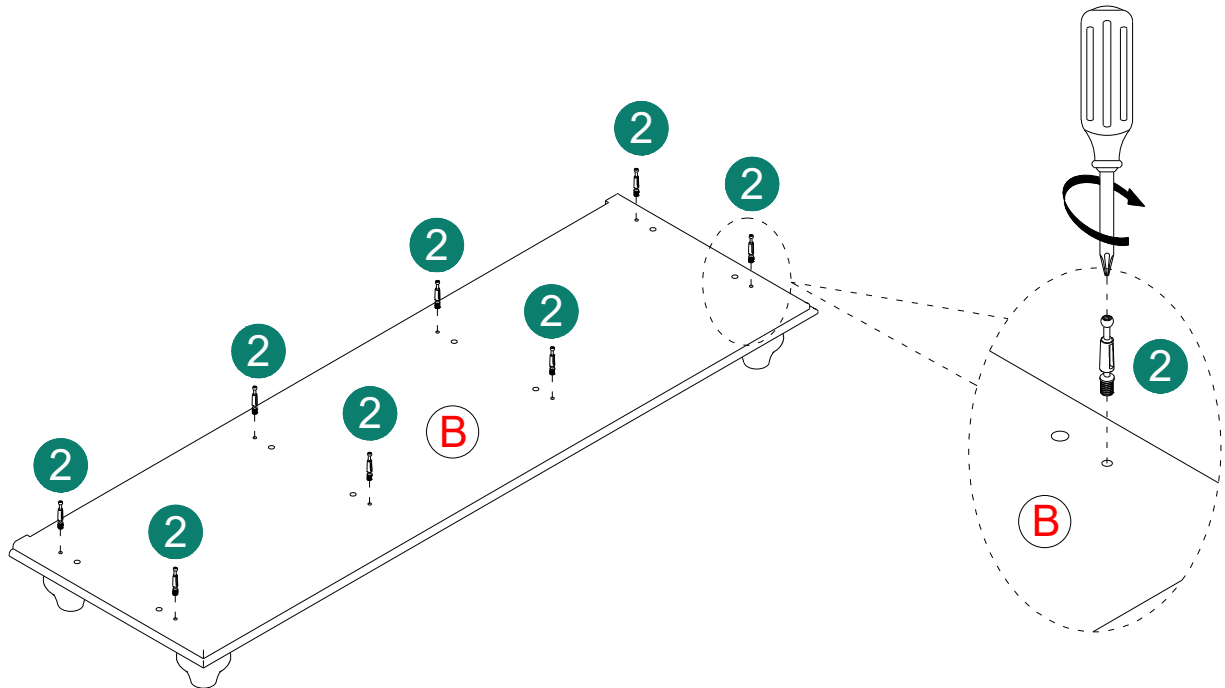
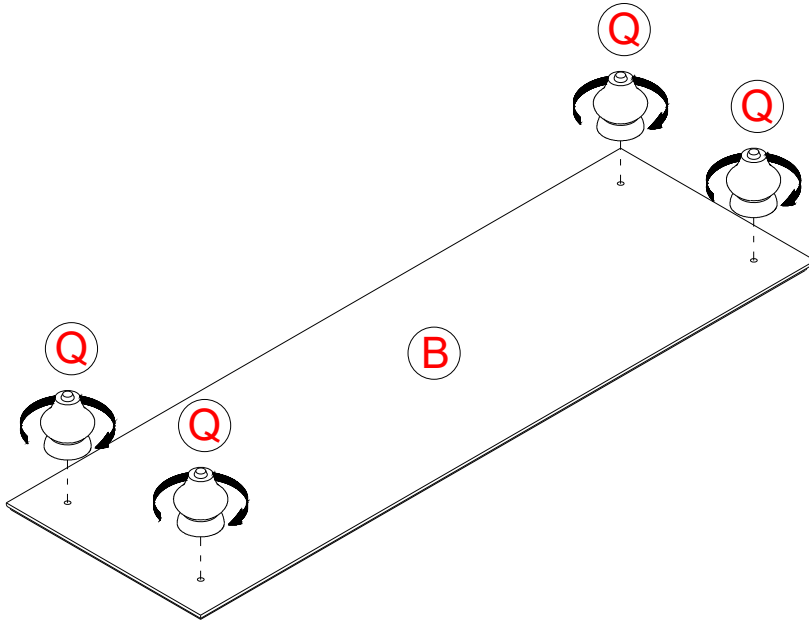

ASSEMBLY INSTRUCTIONS

2

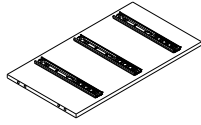

Ⓔ 1PC

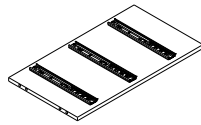

Ⓕ 1PC



Ⓖ 4PCS

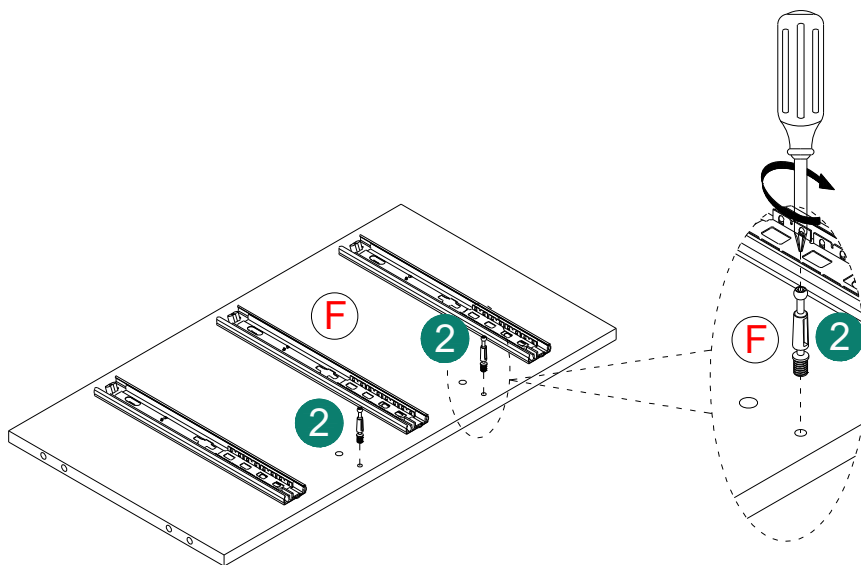
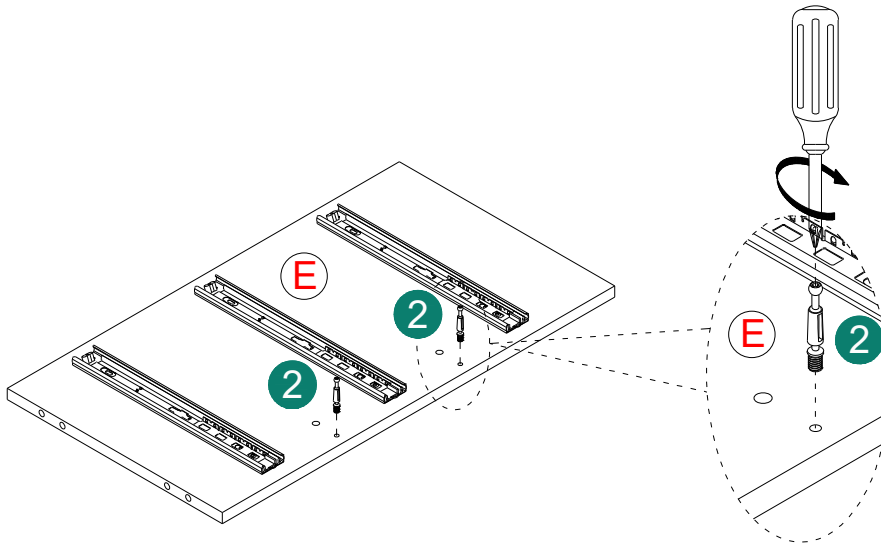

ASSEMBLY INSTRUCTIONS

3

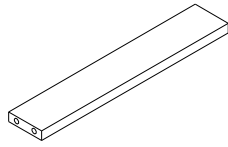

(H) 2PC

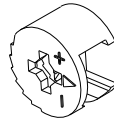

(3) 4PCS

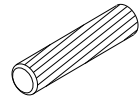

(1) 4PCS

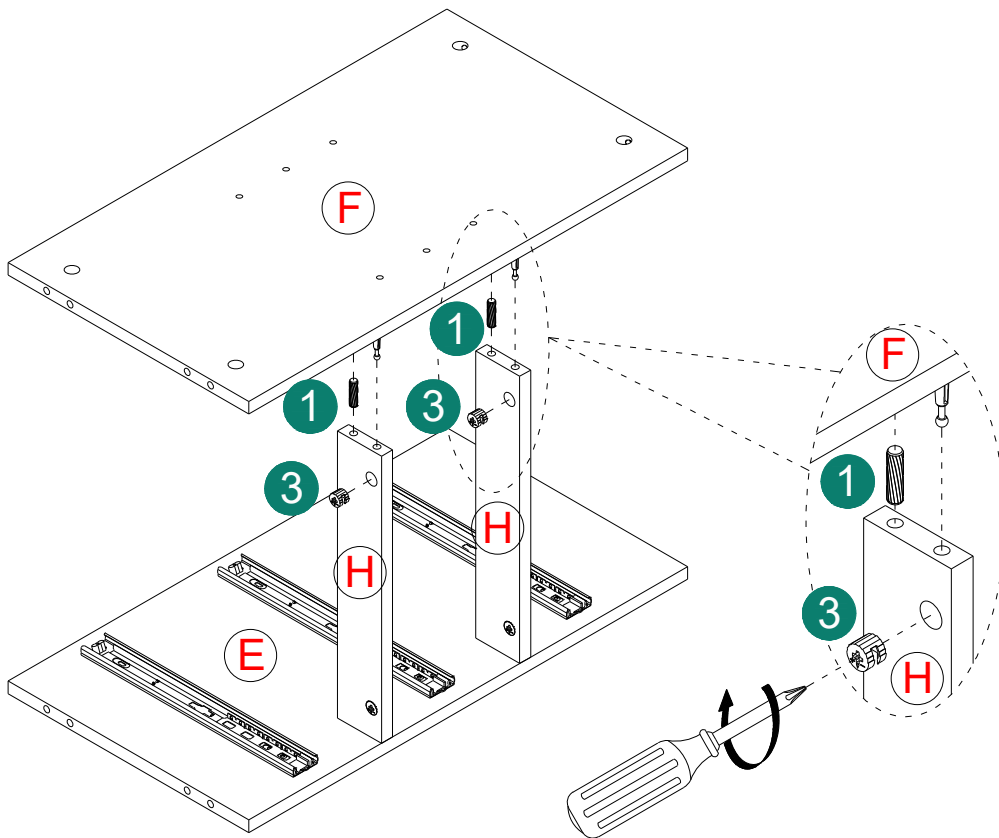
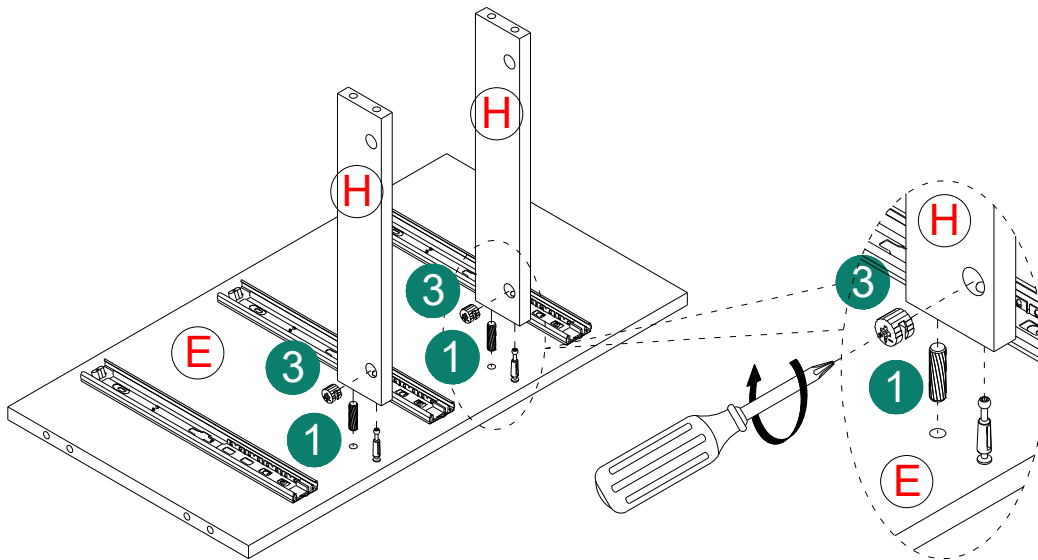

ASSEMBLY INSTRUCTIONS

5

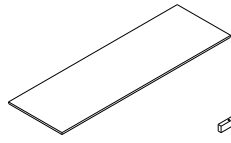

(A) 1PC

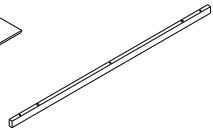

(G) 1PC

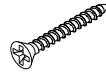

Ø3.5*30mm

(8) 3PCS



(2) 8PCS

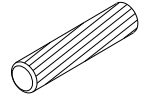

(1) 2PCS

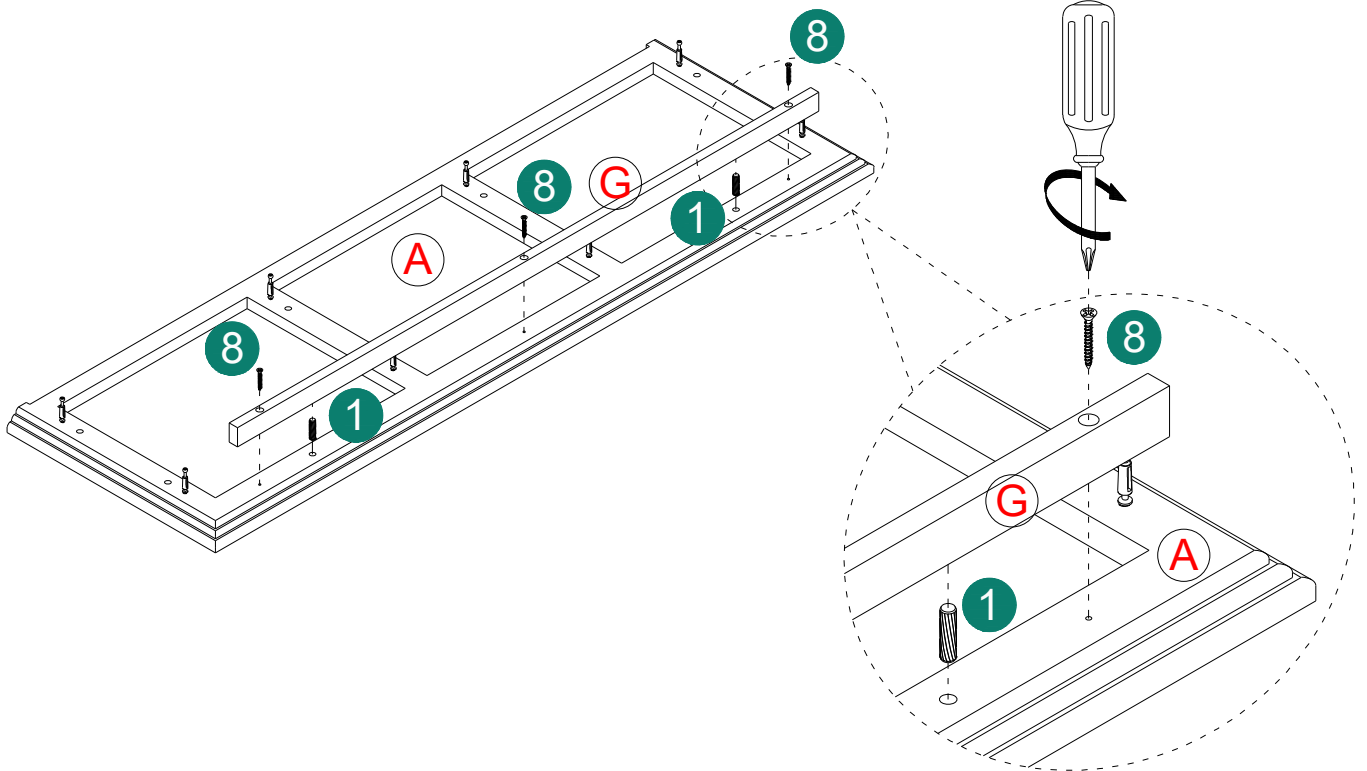
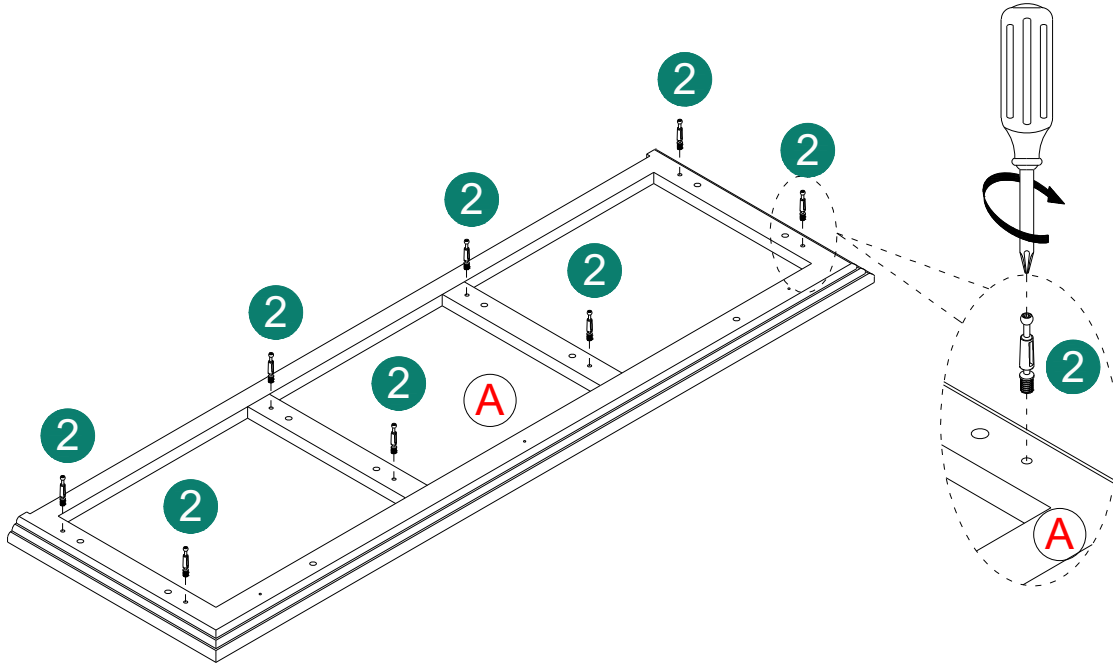

ASSEMBLY INSTRUCTIONS

6

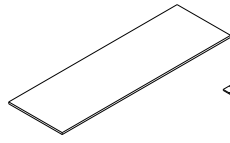

(A) 1PC

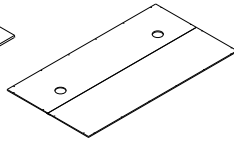

(P) 1PC

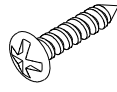

Ø3*15mm

(9) 22PCS

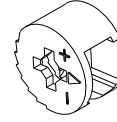

(3) 8PCS

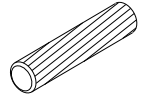

(1) 8PCS

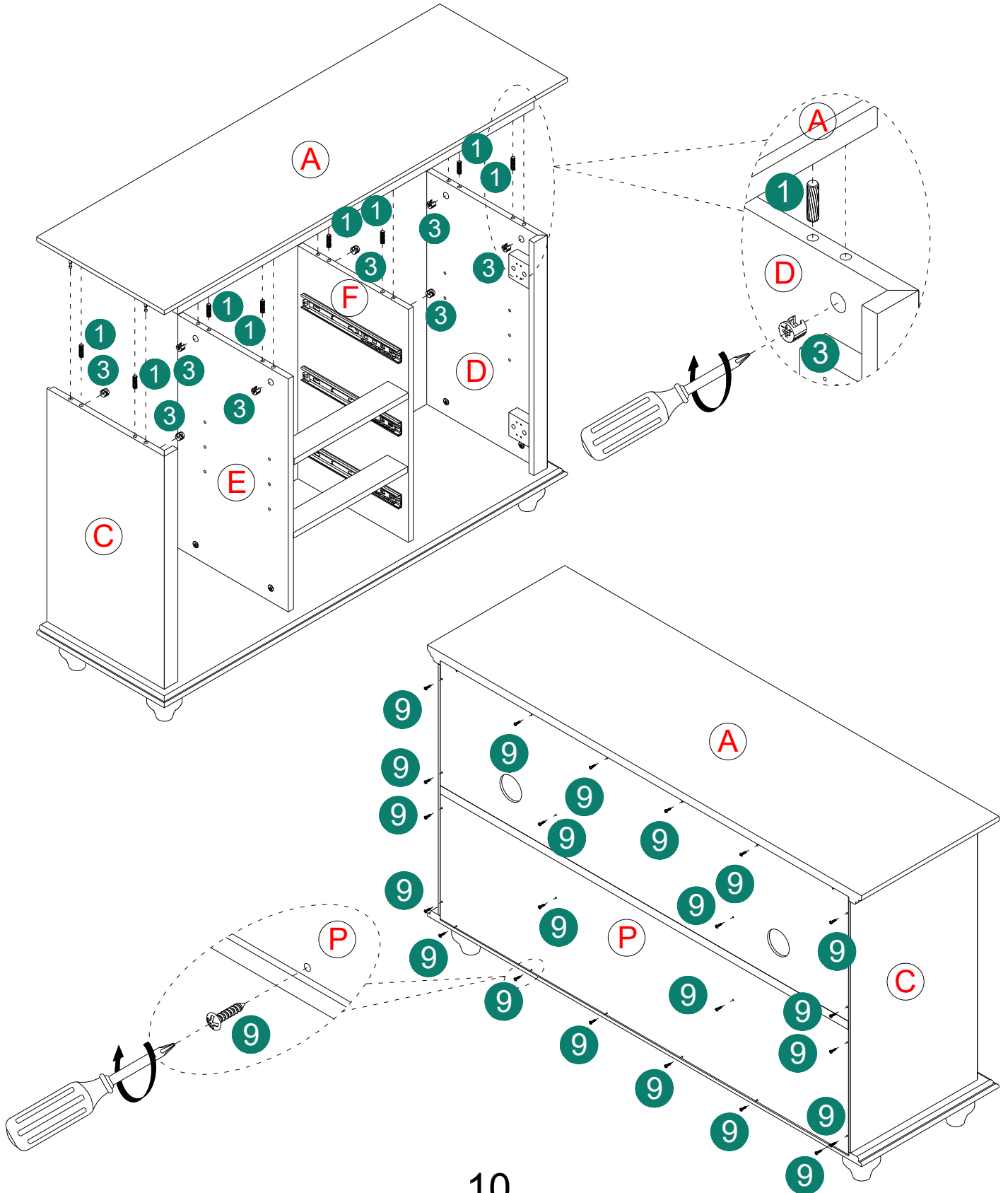

ASSEMBLY INSTRUCTIONS

7

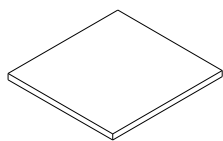

0 2PC



7 8PCS

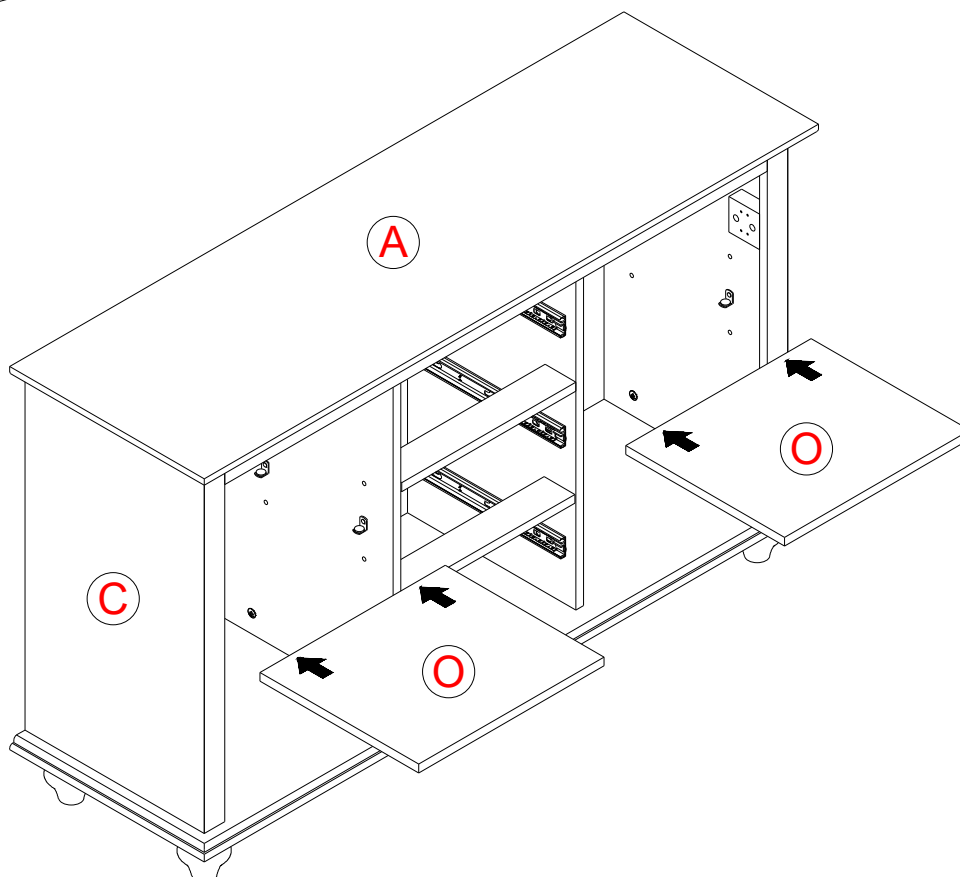
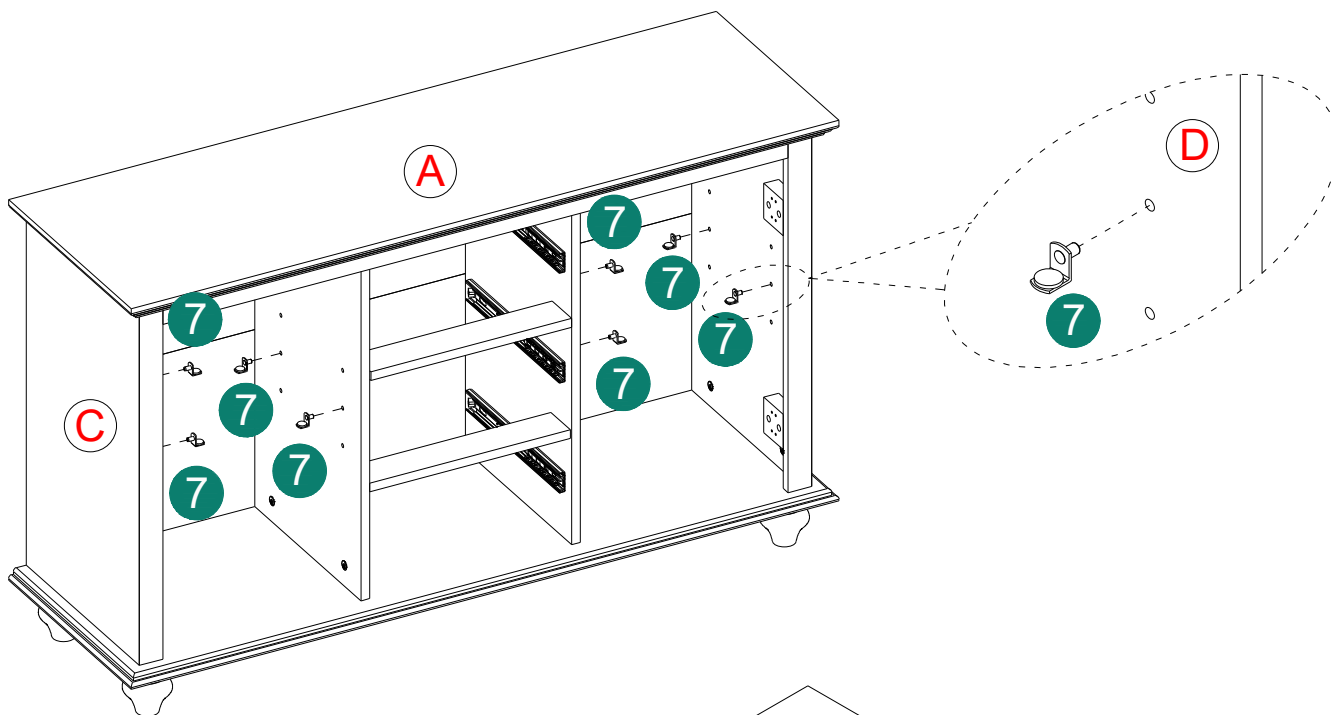

ASSEMBLY INSTRUCTIONS

8

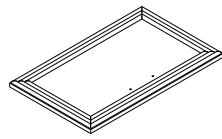

1 2PC

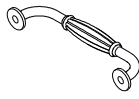

5 2PCS



Ø5*3/4"

6 4PCS

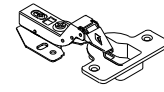

10 4PCS

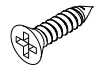

Ø3*14mm

11 24PCS

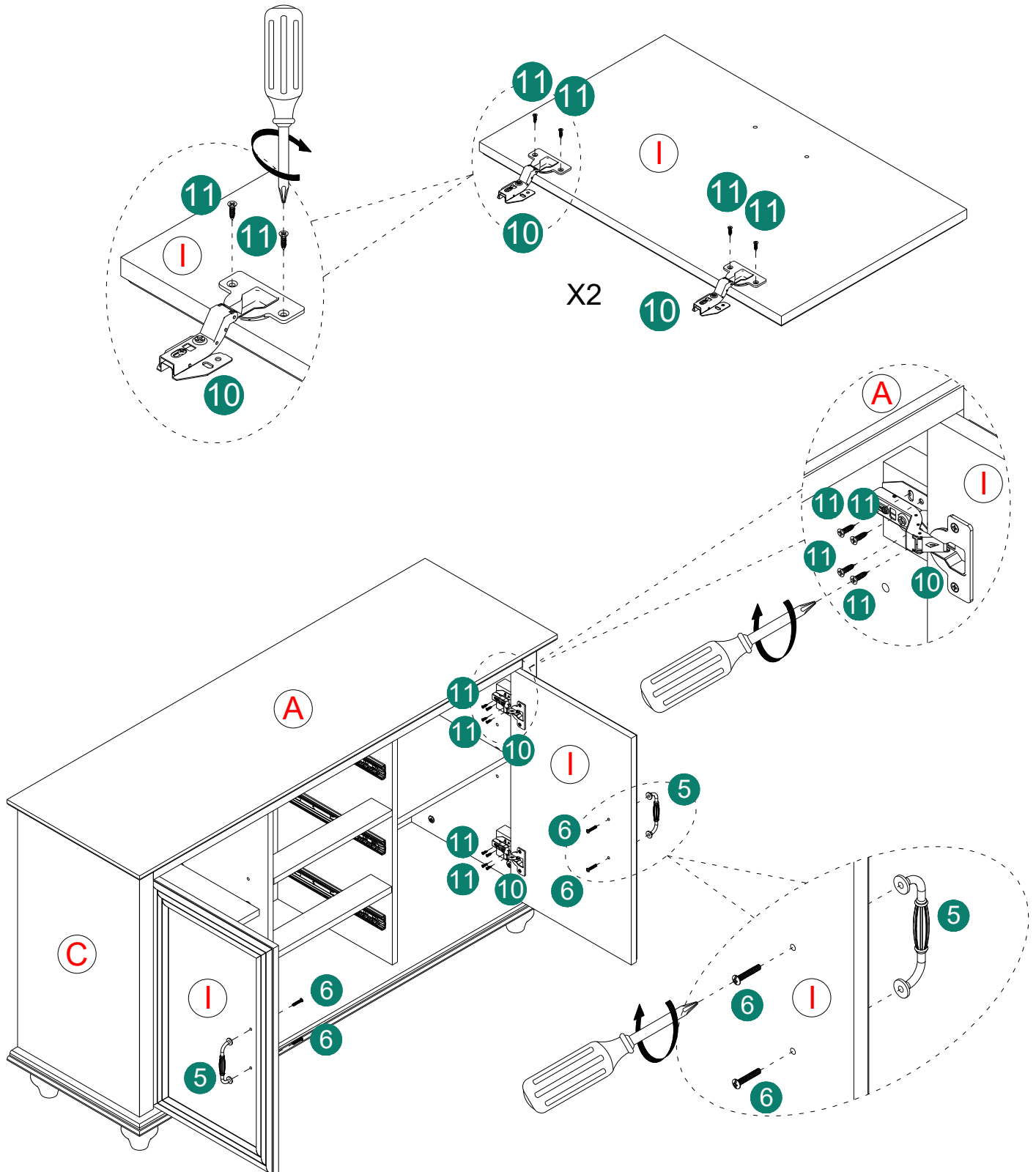

ASSEMBLY INSTRUCTIONS

9

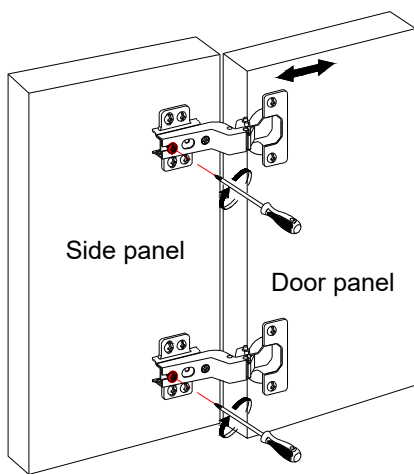

1

Front-to-Back Direction Adjustment:

Rotate the screws on the door hinges shown in the image. The door panel can be moved front-back.

Adjustment range: 4mm

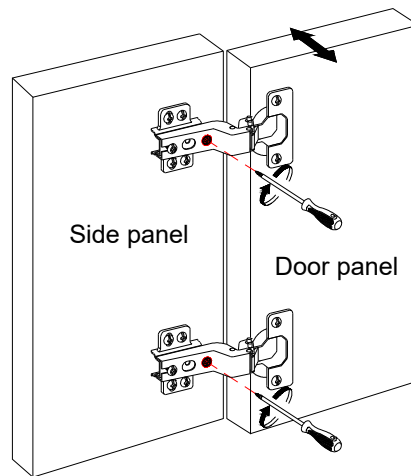

2

Left-Right Direction Adjustment:

Rotate the screws on the door hinges shown in the image. The door panel can be moved left-right.

Adjustment range: 3mm

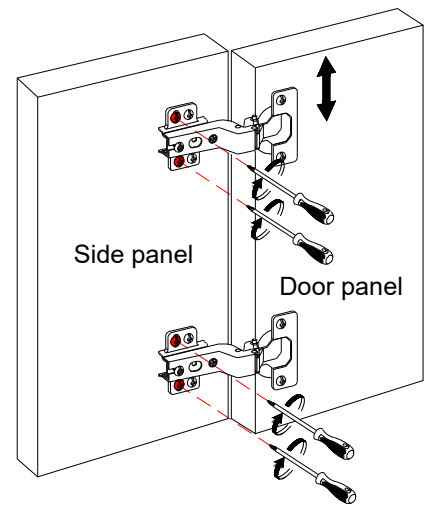

3

Up-Down Direction Adjustment:

Rotate the screws on the door hinges shown in the image. The door panel can be moved up-down.

Adjustment range: 4mm

ASSEMBLY INSTRUCTIONS

10

Common Door Panel Issues:

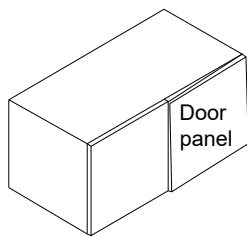

Door panel is not straight

Adjust the door hinges

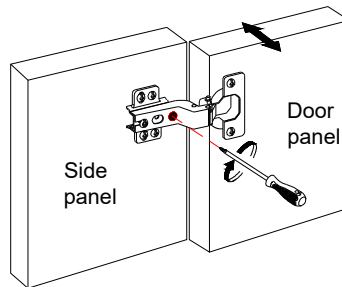
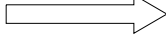

Finished

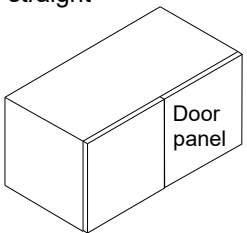
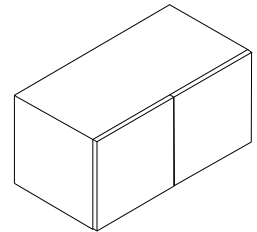

The gap between door panels is too large

Adjust the door hinges

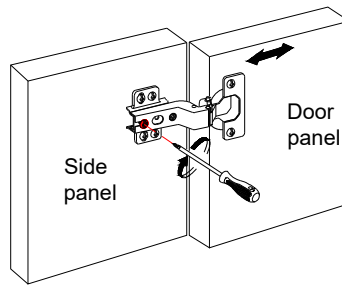
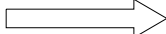

Finished

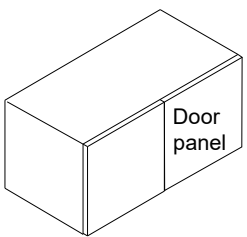
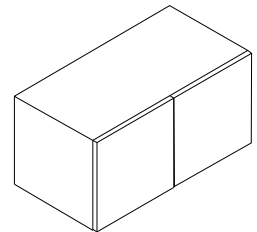

The door panels are not coplanar

Adjust the door hinges

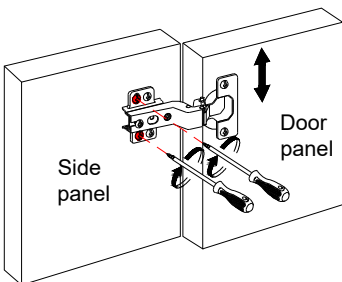
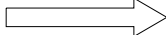

Finished

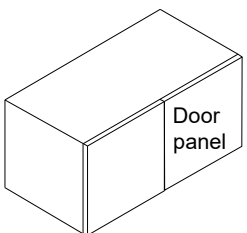
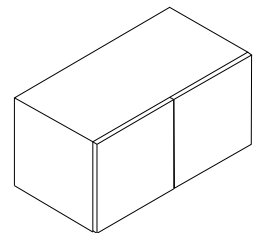
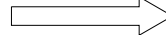

The two door panels are not at the same height

Adjust the door hinges

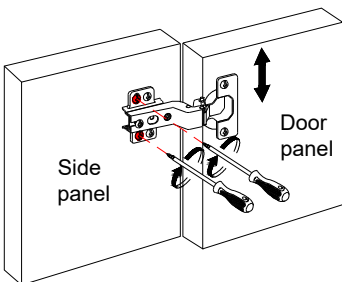
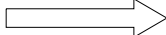

Finished

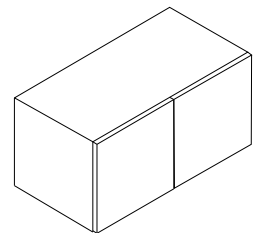
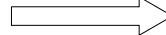

ASSEMBLY INSTRUCTIONS

12

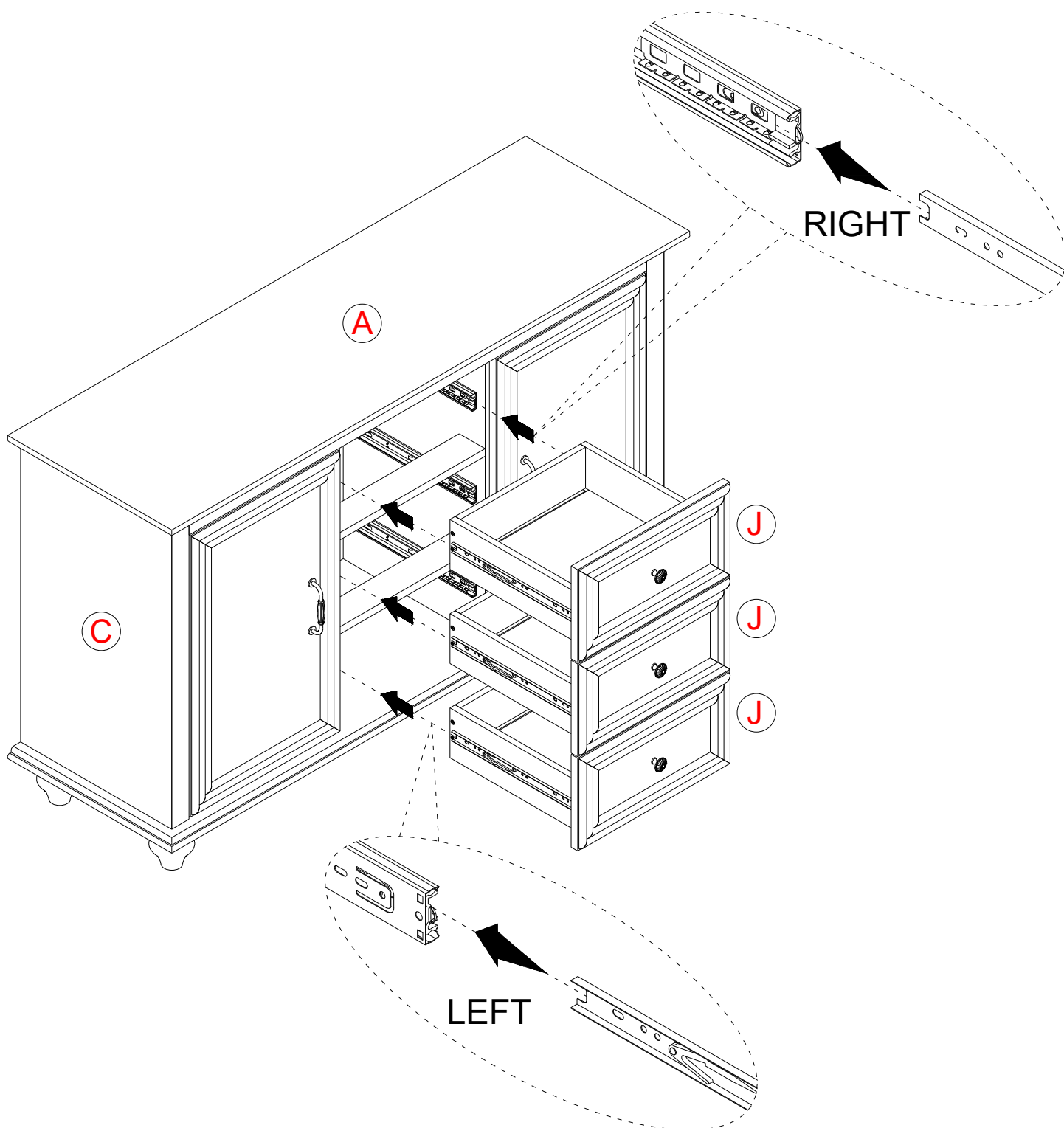

ASSEMBLY INSTRUCTIONS

13

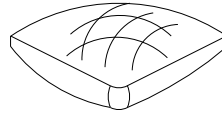

12 2set

A

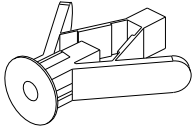

2pcs

B

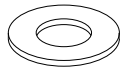

4pcs

C

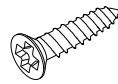

Ø8*3/4"
2pcs

D

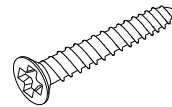

Ø8*1-1/2"
2pcs

E

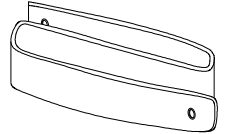

2pcs

WALL

