

Pure & Easy

# ASSEMBLY INSTRUCTIONS

FTPLCG-01108 FTPLCG-01109  
FTPLCG-01110 FTPLCG-01111

JSSBJJ-V1

# NOTICE

IMPORTANT, RETAIN FOR FUTURE REFERENCE: READ CAREFULLY  
WICHTIG, FÜR SPÄTERE NACHSCHLAGE AUFBEWAHREN: SORGFÄLTIG LESEN  
IMPORTANTE, GUARDAR PARA REFERENCIA FUTURA: LEER ATENTAMENTE  
IMPORTANTE, CONSERVARE PER RIFERIMENTI FUTURI: LEGGERE ATTENTAMENTE  
IMPORTANT, À CONSERVER POUR RÉFÉRENCE FUTURE : LIRE ATTENTIVEMENT

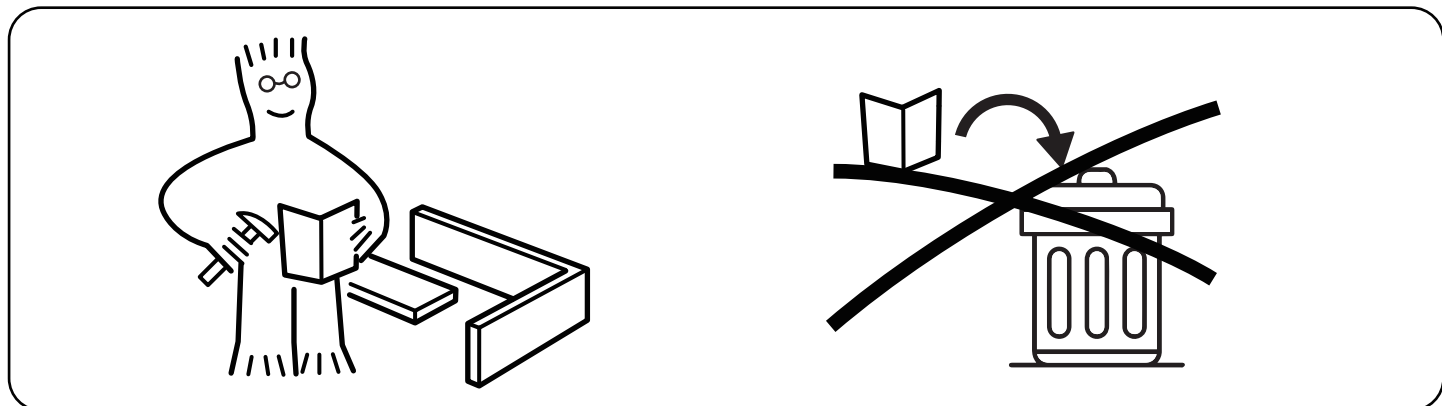

Assemble on a flat, clean and soft surface.  
Auf einer flachen, sauberen und weichen Oberfläche zusammenbauen.  
Assembler sur une surface plate, propre et douce.  
Assemblare su una superficie piatta, pulita e morbida.  
Ensamblar sobre una superficie plana, limpia y suave.

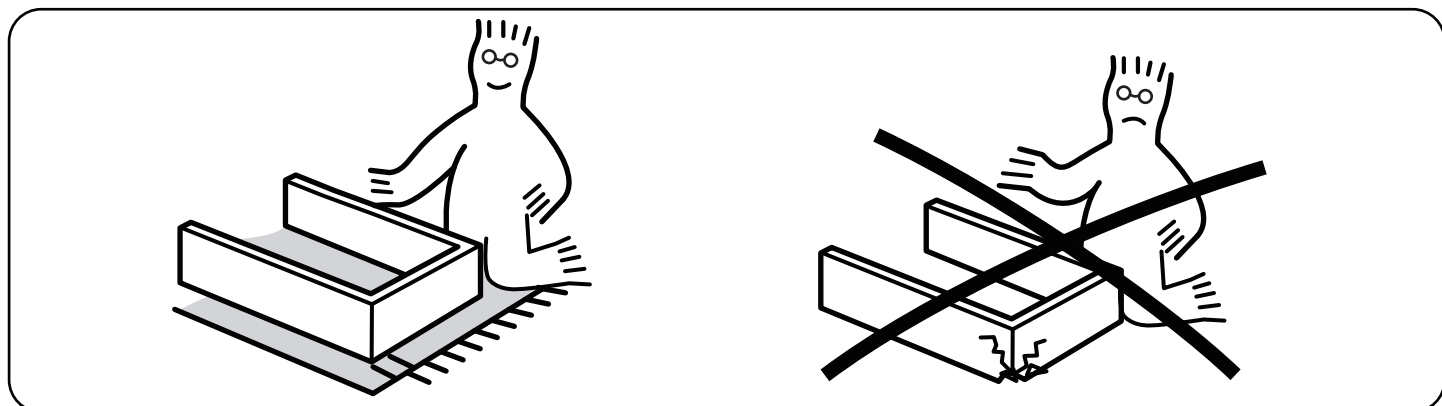

Professional installation is highly recommended.  
Eine professionelle Installation wird dringend empfohlen.  
Une installation professionnelle est fortement recommandée.  
Si raccomanda vivamente l'installazione professionale.  
Se recomienda altamente la instalación profesional.



Periodically Check That All Components Are Tightly Secured.  
Überprüfen Sie Regelmäßig, Dass Alle Komponenten Fest Gesichert Sind.  
Vérifiez Périodiquement Que Tous Les Composants Sont Bien Fixés.  
Controllare Periodicamente Che Tutti I Componenti Siano Ben Fissati.  
Verifique Periódicamente Que Todos Los Componentes Estén Bien Asegurados.

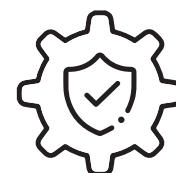

It is recommended that multiple people assemble this product.  
Es wird empfohlen, dass mehrere Personen dieses Produkt zusammenbauen.  
Il est recommandé que plusieurs personnes assemblent ce produit.  
Si raccomanda che più persone assemblino questo prodotto.  
Se recomienda que varias personas ensamblen este producto.

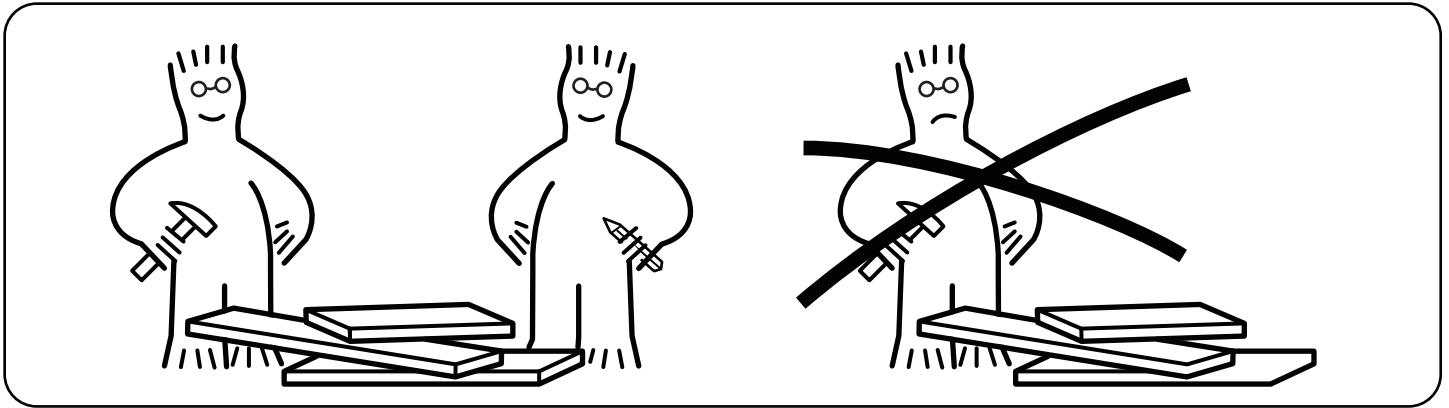

Please have the following auxiliary tools ready:

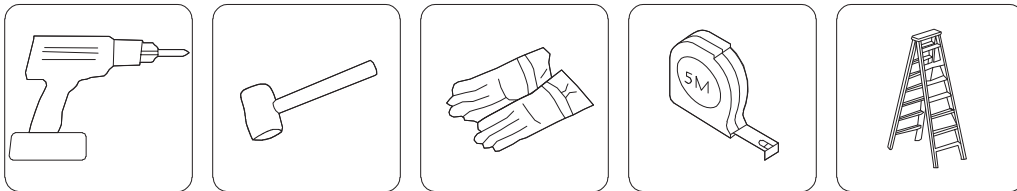



# WARNING

- Must use ground nails, ropes, and expansions screws for whichever ground you install on for stability to avoid devastating injuries for people inside or nearby and property damage caused by a collapsing gazebo.
- Do not use this gazebo in high winds, heavy snow, or inclement weather. It is not designed to withstand strong gusts of wind, heavy snow accumulation, or other inclement weather. Must take precautions when the wind speed exceeds 25Mph, and clear snow when it accumulates more than 2 inches.
- Before use, thoroughly inspect the gazebo to make sure all bolts, nuts, and buckles have been completely tightened and securely fastened.
- Warranty does not cover damages, losses, or injuries resulting from improper installation, misuse, not using stability accessories mentioned above, non snow cleaning, failure to take precautionary measures, etc.

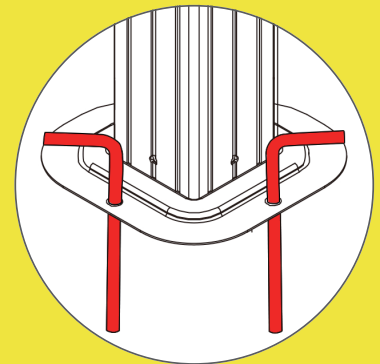
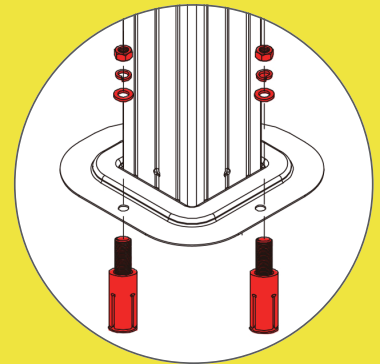



The following installation methods will provide better wind resistance performance, extend the product's lifespan, and help you maximize its value, delivering an even better user experience.

**1**

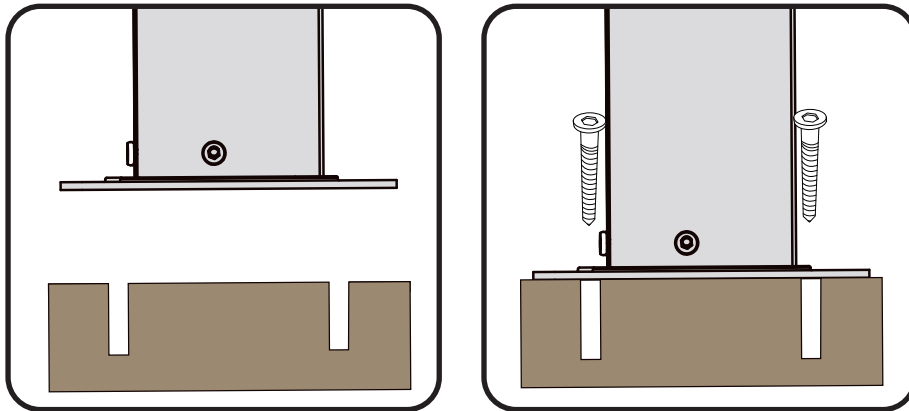



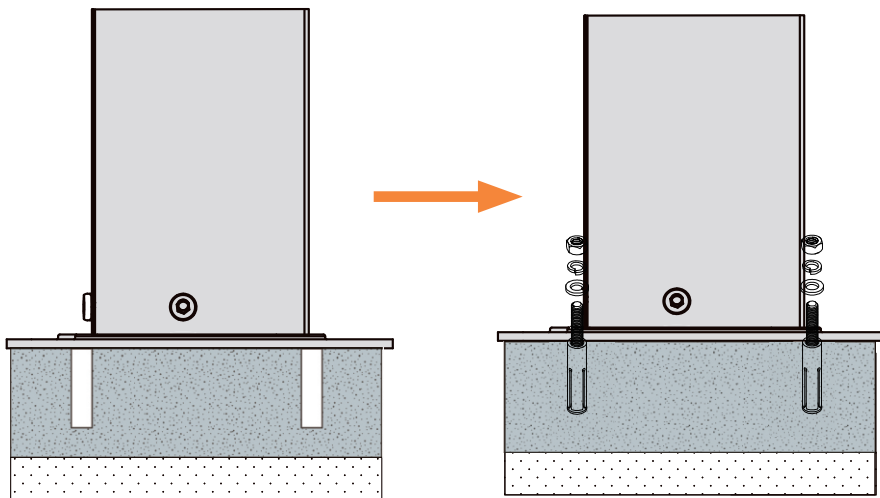







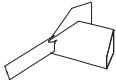



If the deck you are installing is made of hardwood and has a depth exceeding 40mm, you can use ST8\*35mm screws to secure it in place. (This hardware is not included with the product, so you will need to purchase it separately.)















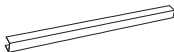

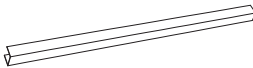





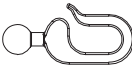

**2**

The best option is to fix it on a concrete surface. You can use the expansion bolts that are pre-configured with the product to secure it in place.

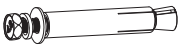
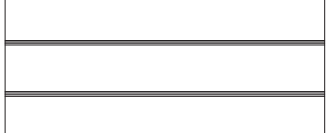
# PARTS

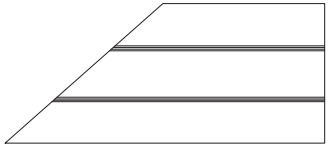
Item no. Nr. N° d'article Articolo No. Artículo No.	Reference Image Referenzbild Image de référence Immagine di riferimento Imagen de referencia	Qty. Menge Qté. Qtà Cant.	Item no. Nr. N° d'article Articolo No. Artículo No.	Reference Image Referenzbild Image de référence Immagine di riferimento Imagen de referencia	Qty. Menge Qté. Qtà Cant.
<b>A1</b>		X4	<b>F1</b>		X4
<b>A2</b>		X4	<b>F2</b>		X4
<b>B2</b>		X4	<b>G1</b>		X4
<b>C</b>		X8	<b>G2</b>		X4
<b>D1</b>		X8	<b>J2</b>		X4
<b>D2</b>		X4	<b>K1</b>		X4
<b>E1</b>		X4	<b>L</b>		X4
<b>E2</b>		X4	<b>L2</b>		X4

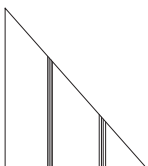
Item no. Nr. N° d'article Articolo No. Artículo No.	Reference Image Referenzbild Image de référence Immagine di riferimento Imagen de referencia	Qty. Menge Qté. Qtà Cant.	Item no. Nr. N° d'article Articolo No. Artículo No.	Reference Image Referenzbild Image de référence Immagine di riferimento Imagen de referencia	Qty. Menge Qté. Qtà Cant.
<b>N</b>		<b>X1</b>	<b>V2</b>		<b>X8</b>
<b>P</b>		<b>X1</b>	<b>#1</b>	 <b>M6 X 15MM</b>	<b>X100</b>
<b>Q1</b>		<b>X8</b>	<b>#2</b>	 <b>M6 X 35MM</b>	<b>X25</b>
<b>Q2</b>		<b>X20</b>	<b>#3</b>	 <b>M6</b>	<b>X12</b>
<b>R</b>		<b>X2</b>	<b>#4</b>	 <b>M5 X 20MM</b>	<b>X28</b>
<b>U1</b>		<b>X8</b>	<b>#5</b>		<b>X12</b>
<b>U2</b>		<b>X20</b>	<b>#6</b>		<b>X1</b>
<b>V1</b>		<b>X80</b>	<b>#7</b>		<b>X1</b>

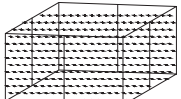
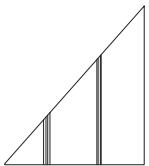
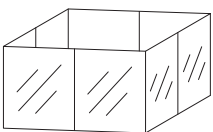
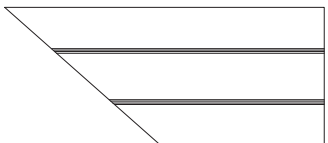
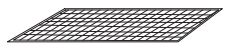
Item no. Nr. N° d'article Articolo No. Artículo No.	Reference Image Referenzbild Image de référence Immagine di riferimento Imagen de referencia	Qty. Menge Qté. Qtà Cant.	Item no. Nr. N° d'article Articolo No. Artículo No.	Reference Image Referenzbild Image de référence Immagine di riferimento Imagen de referencia	Qty. Menge Qté. Qtà Cant.
#8		X12	EE		X4
#9		X16	FF		X4
AA		X4	GG		X4
BB		X4	X		X1
CC		X4	Y		X1
DD		X4	Z		X1



# ASSEMBLY

**1**

**X4**



B2 4pcs



J2 4pcs



#1 12pcs



#3 12pcs

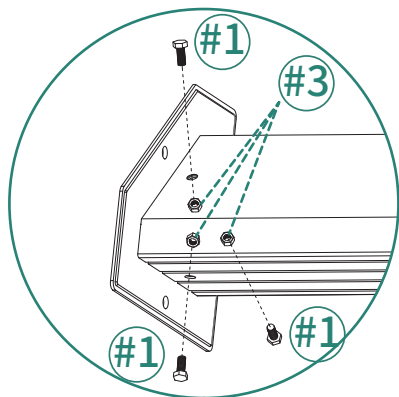
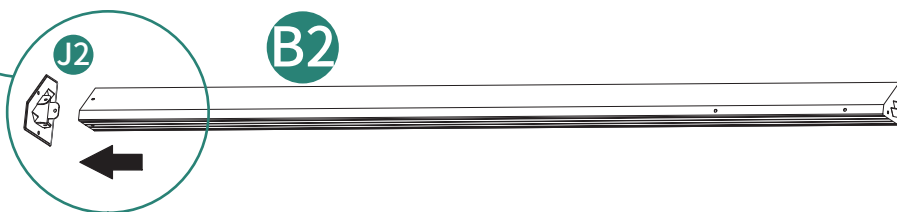
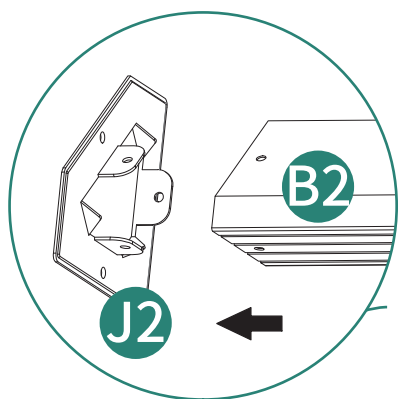

# 2

## X4



A1 4pcs

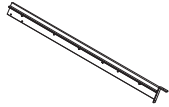

A2 4pcs

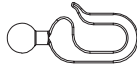

V1 80pcs



V2 8pcs



K1 4pcs



#1 24pcs

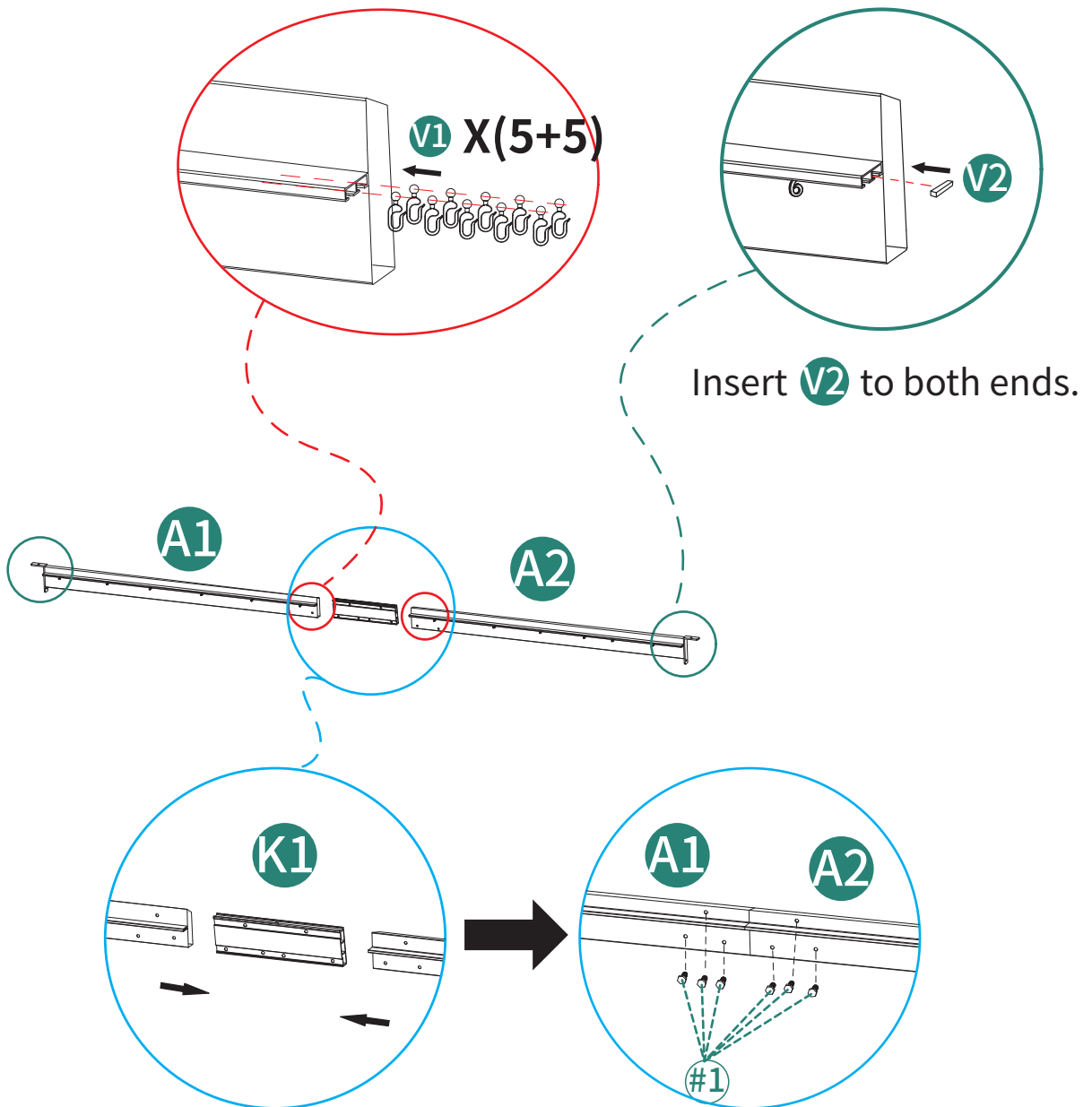

**3**



#1 16pcs

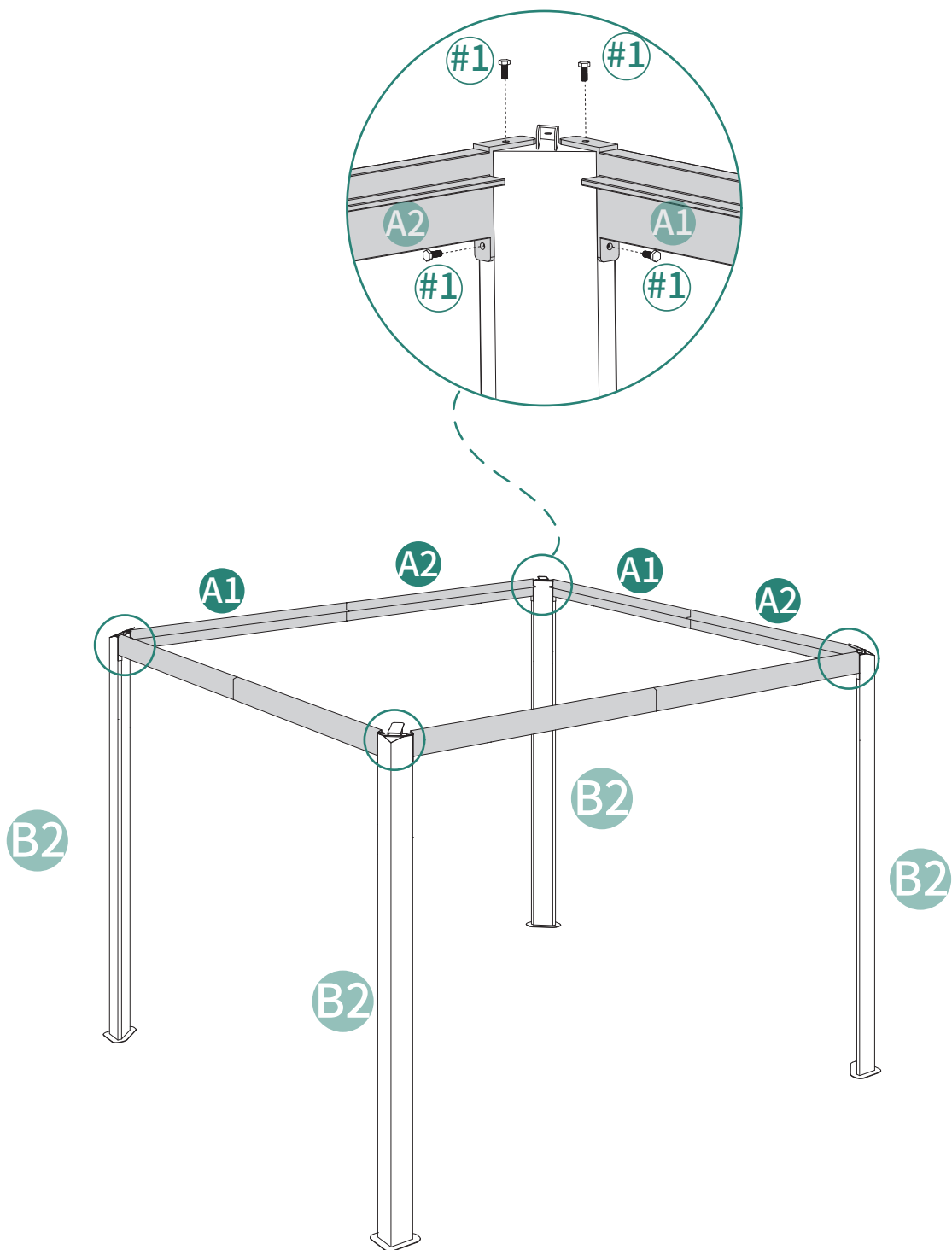

4



Ⓒ8pcs



#116pcs

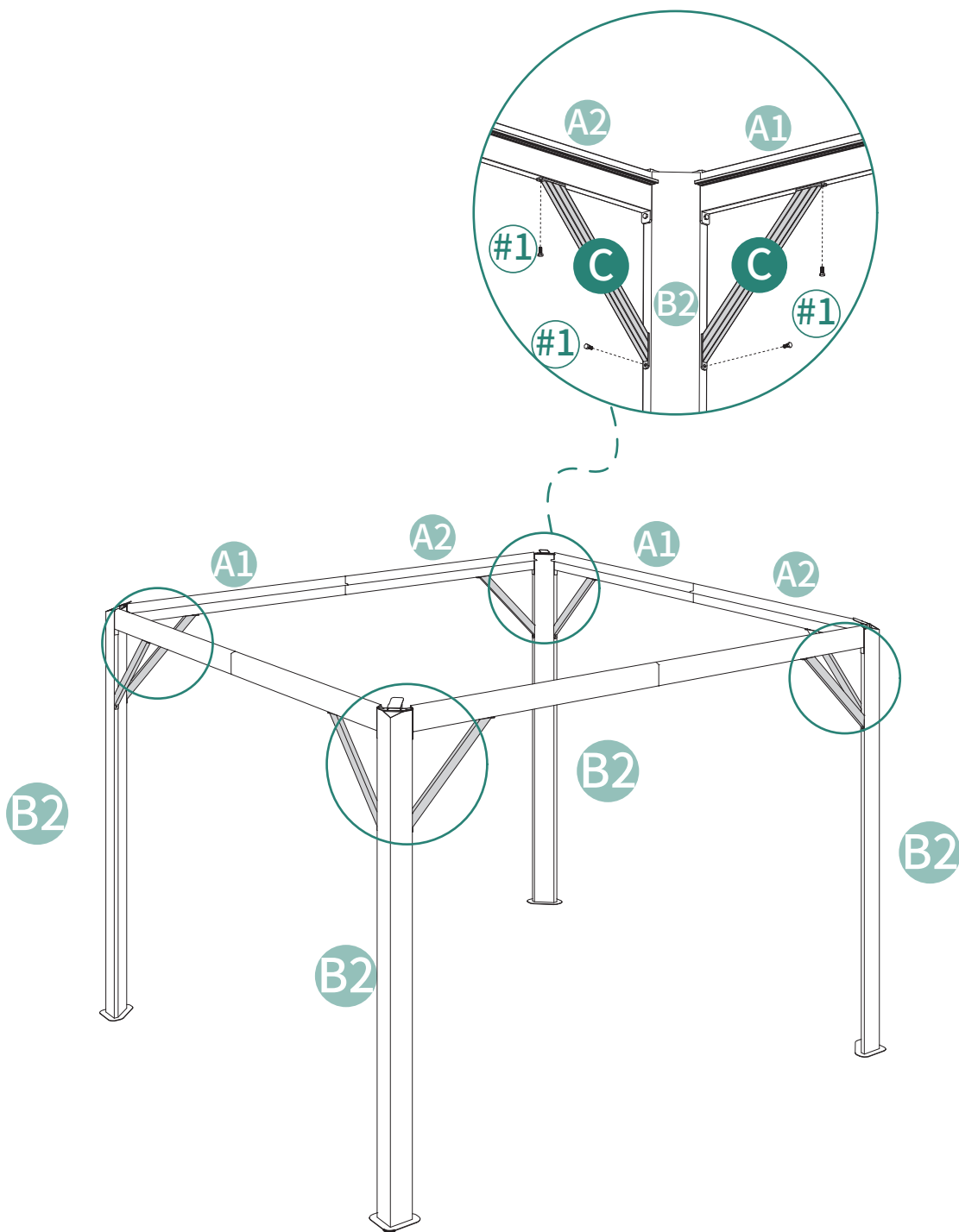

5

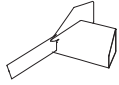

F1 4pcs



F2 4pcs



#1 8pcs

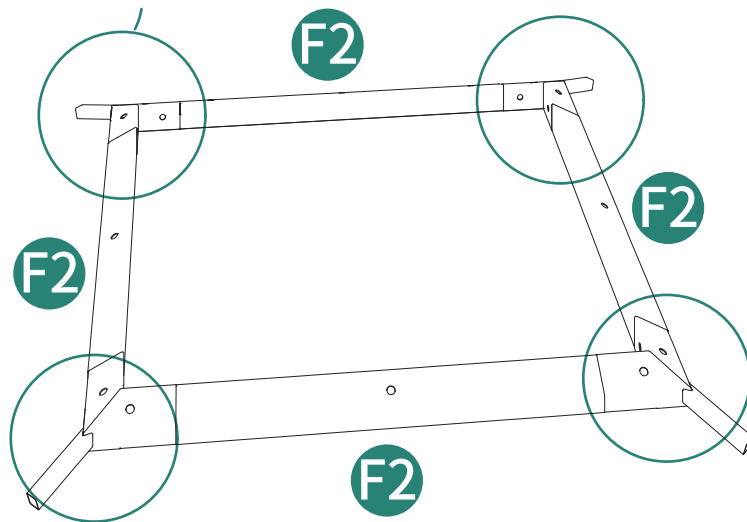
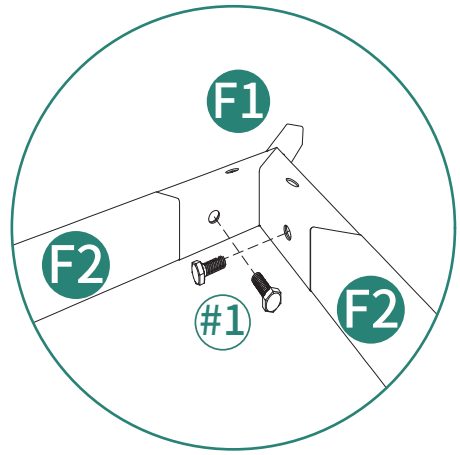
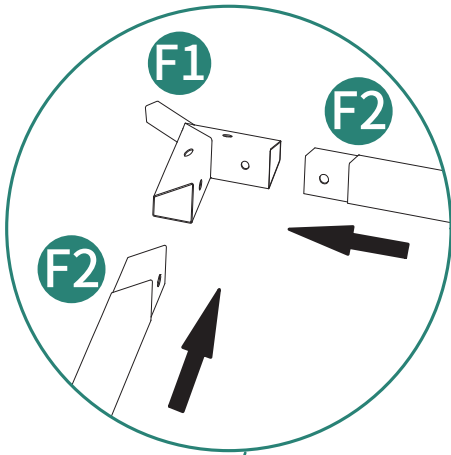

6



G1 4pcs



#1 4pcs

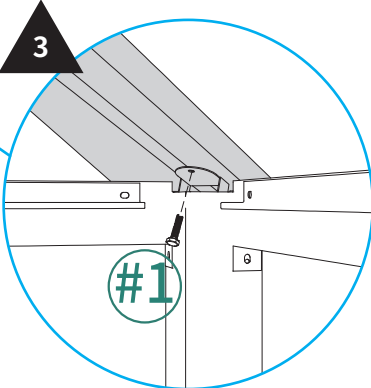
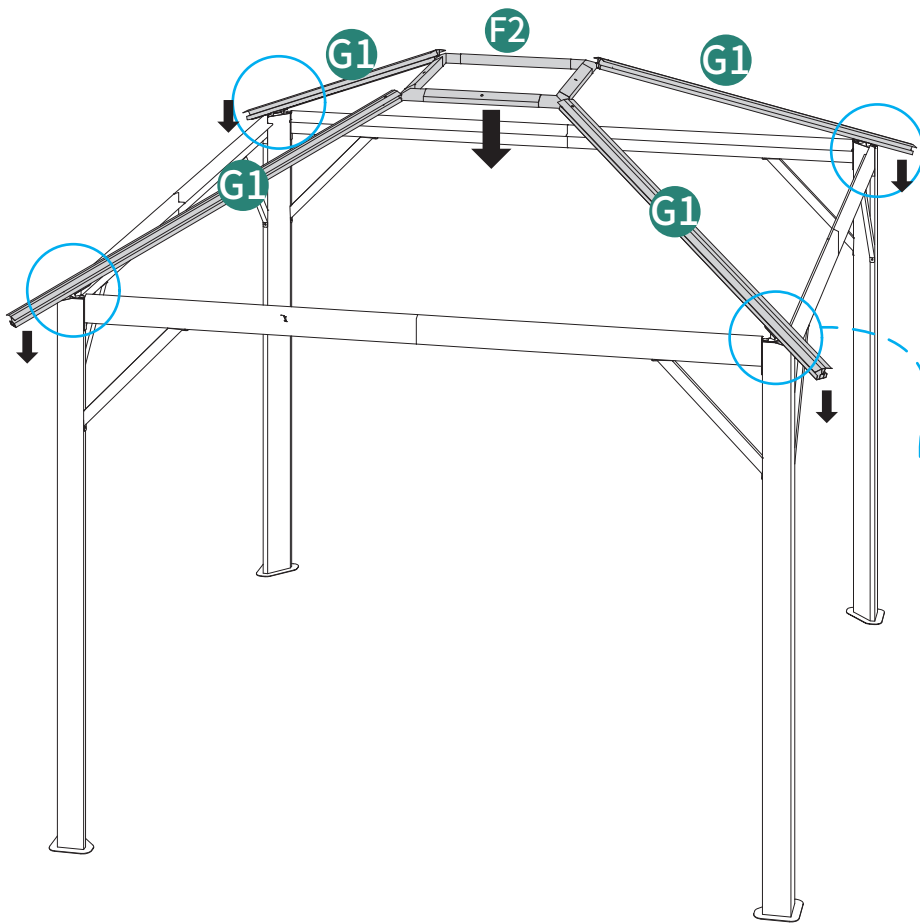
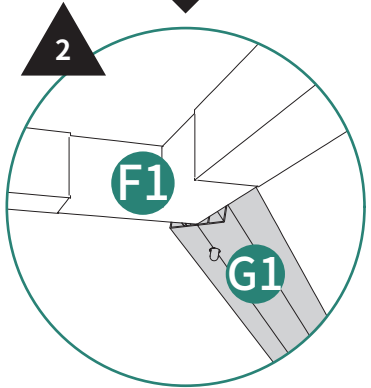
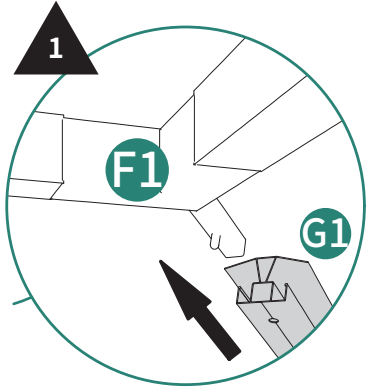
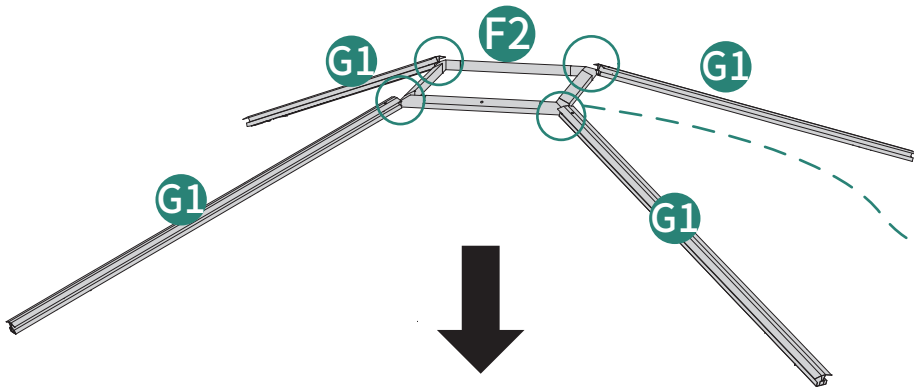

# 7

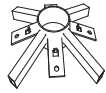

Ⓟ1pc



Ⓞ24pcs



Ⓞ24pcs



Ⓝ18pcs

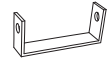

Ⓞ4pcs

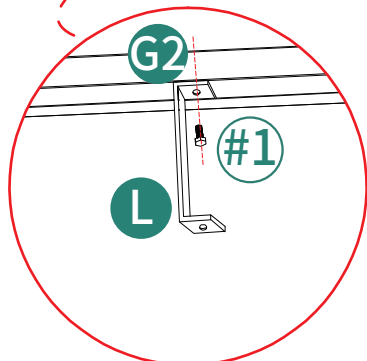
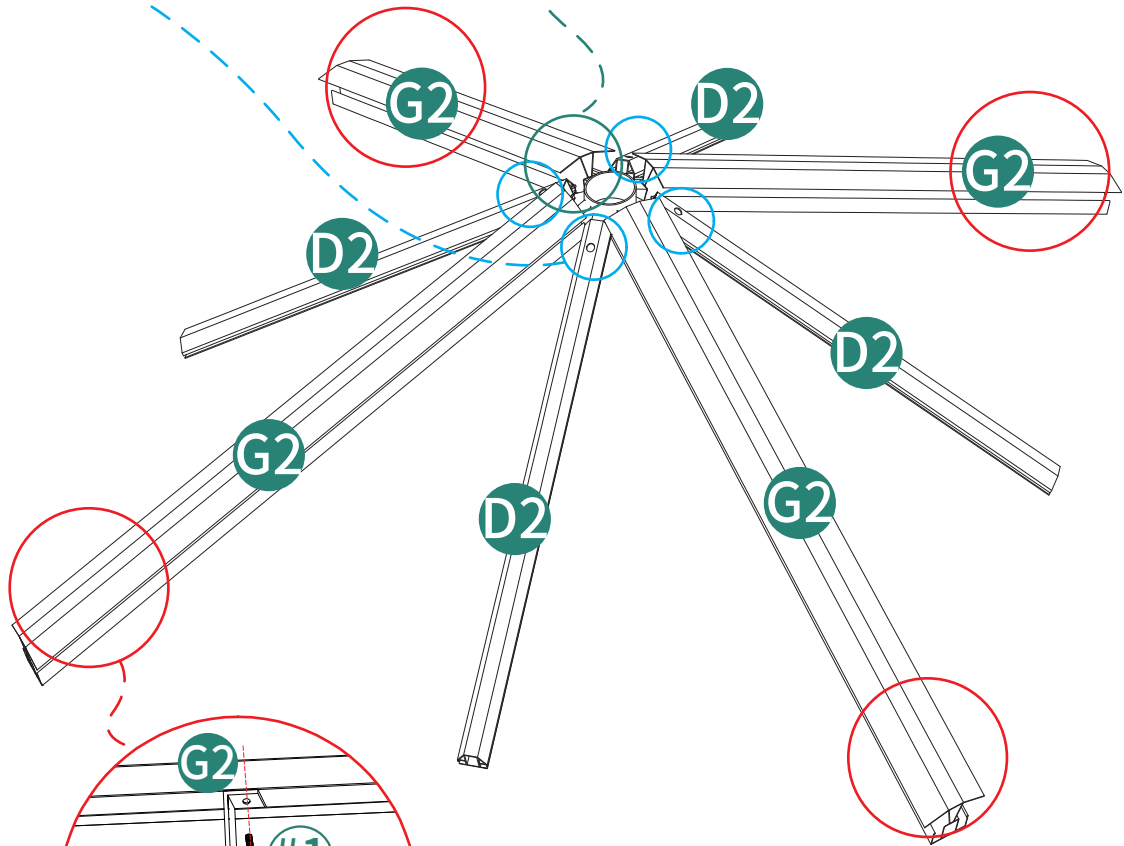
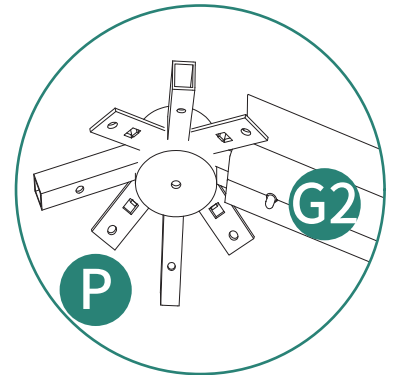
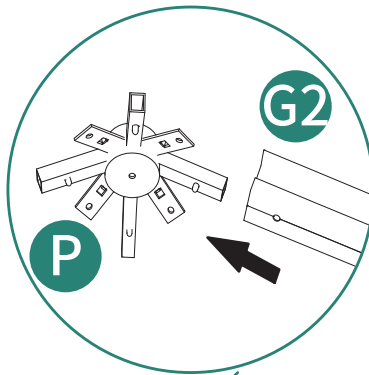
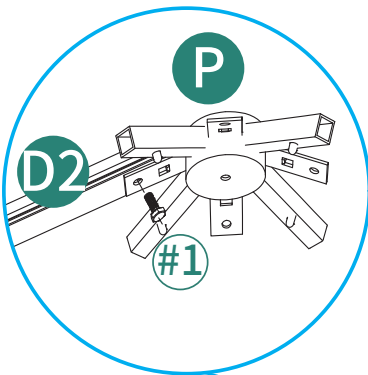

8



Ⓝ1pc



#21pc



#14pcs

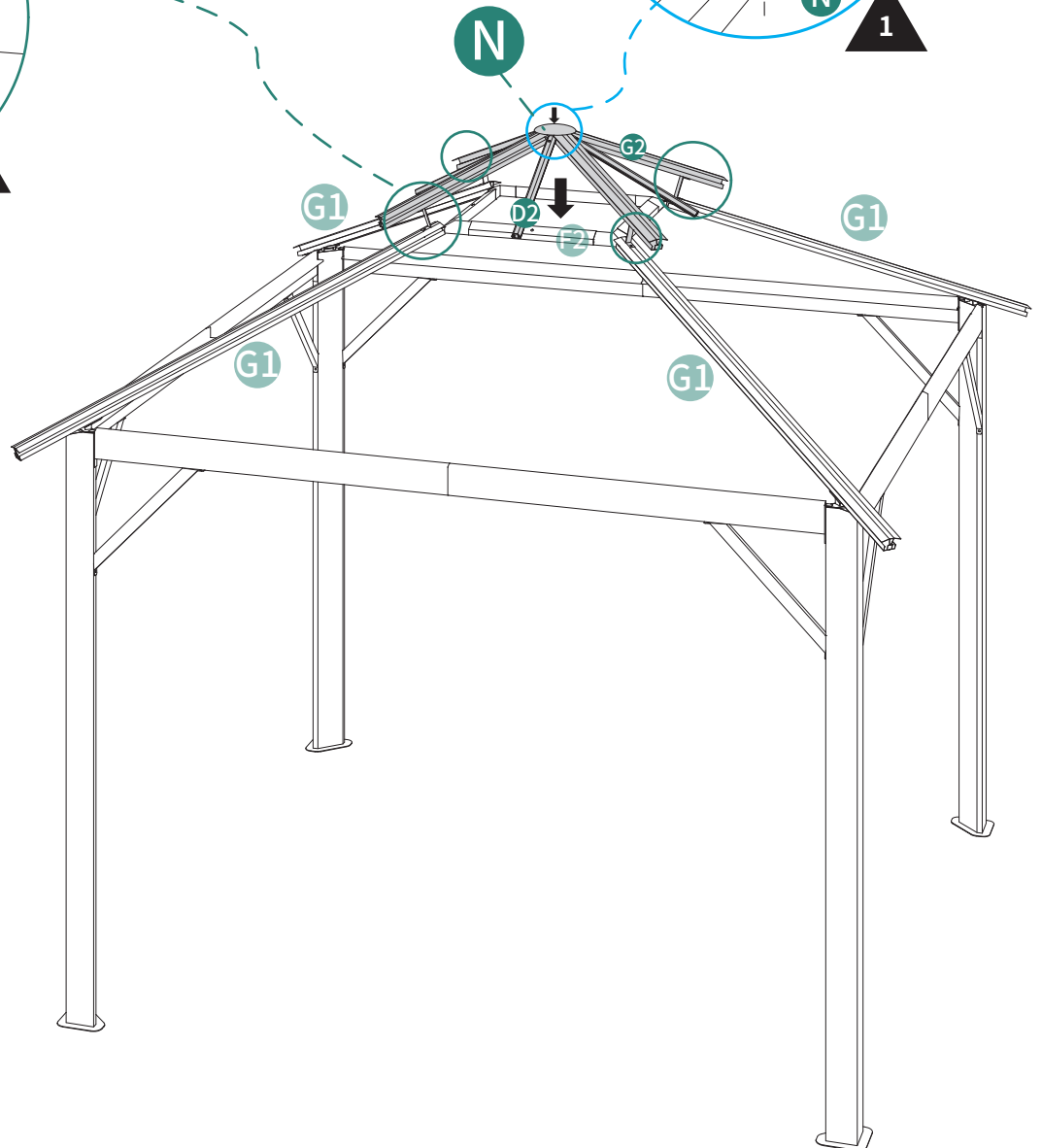
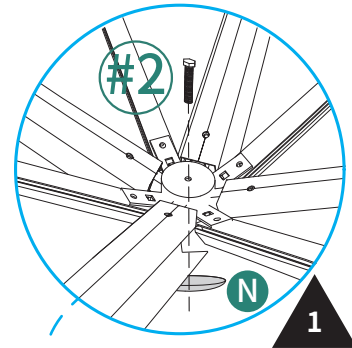
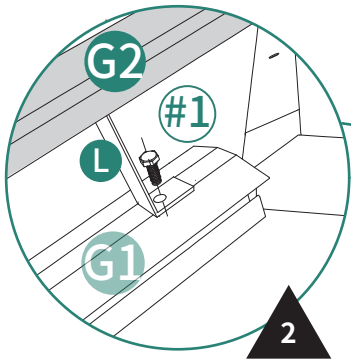

9

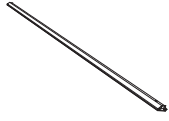

D1 8pcs



E1 4pcs



E2 4pcs



#2 24pcs

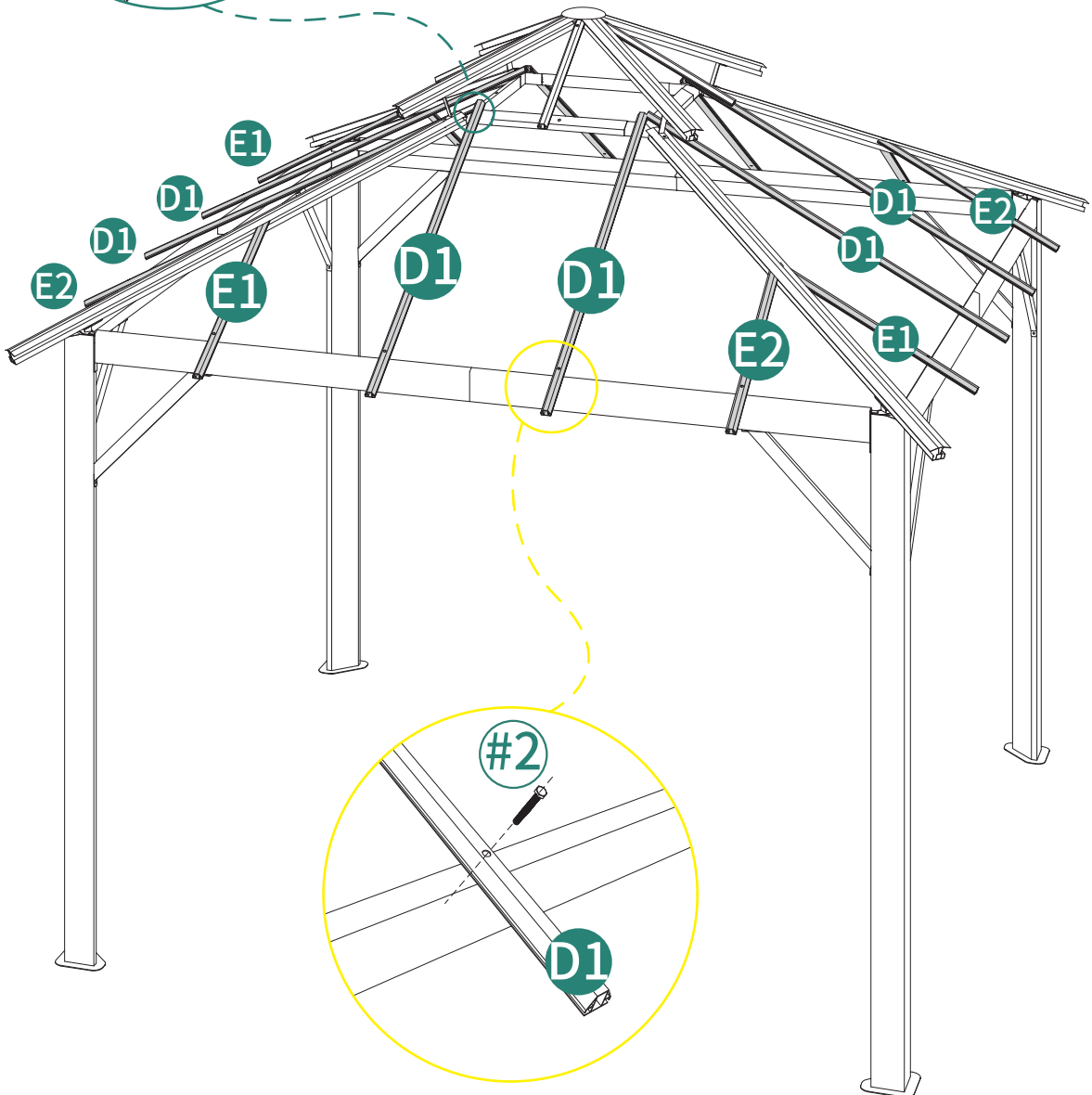
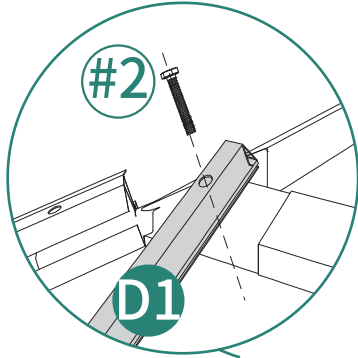

# 10

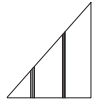

AA 4pcs

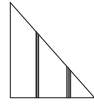

BB 4pcs



U2 4pcs



#4 8pcs

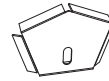

U1 4pcs

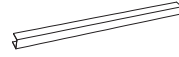

Q1 8pcs

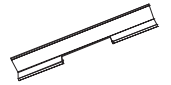

#9 8pcs

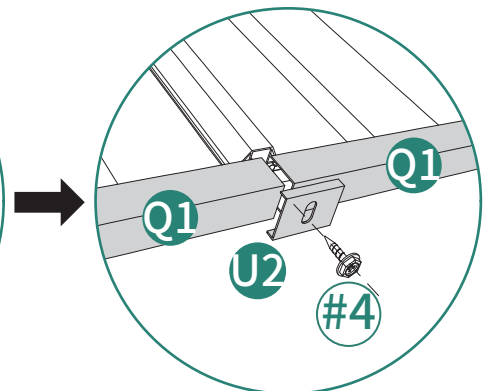
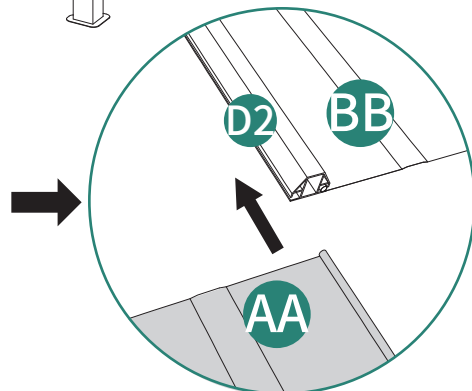
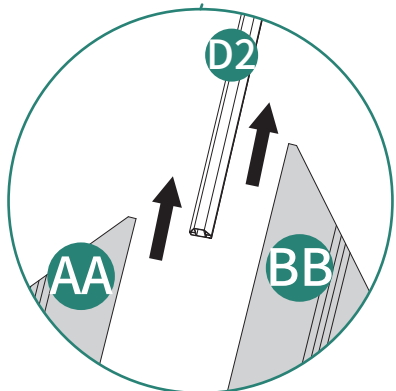
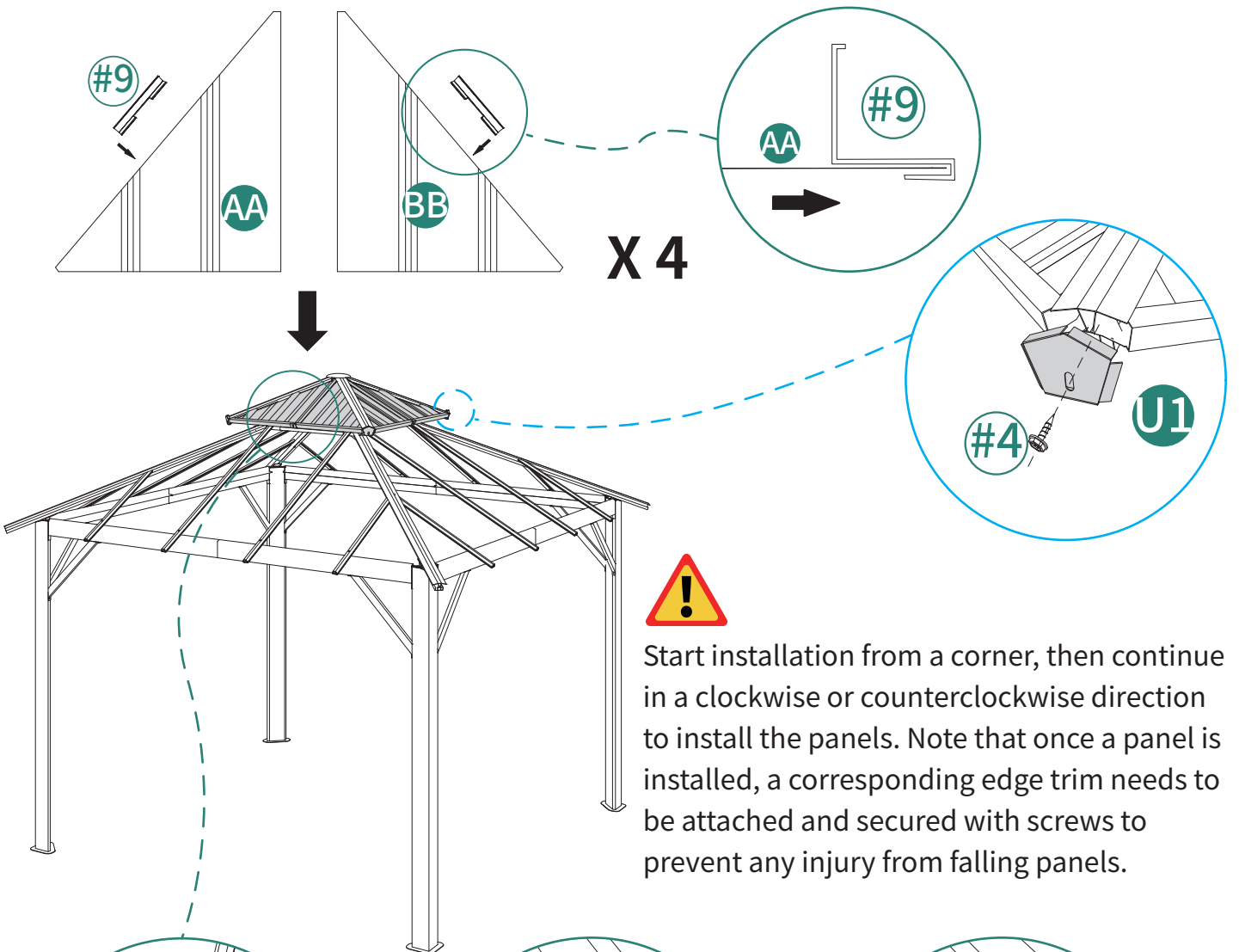

# 11

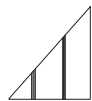

CC 4pcs

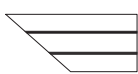

DD 4pcs

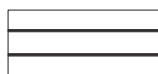

EE 4pcs



Q2 12pcs



U2 8pcs



#4 8pcs

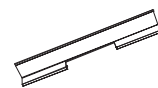

#9 4pcs



Start installation from a corner, then continue in a clockwise or counterclockwise direction to install the panels. Note that once a panel is installed, a corresponding edge trim needs to be attached and secured with screws to prevent any injury from falling panels.

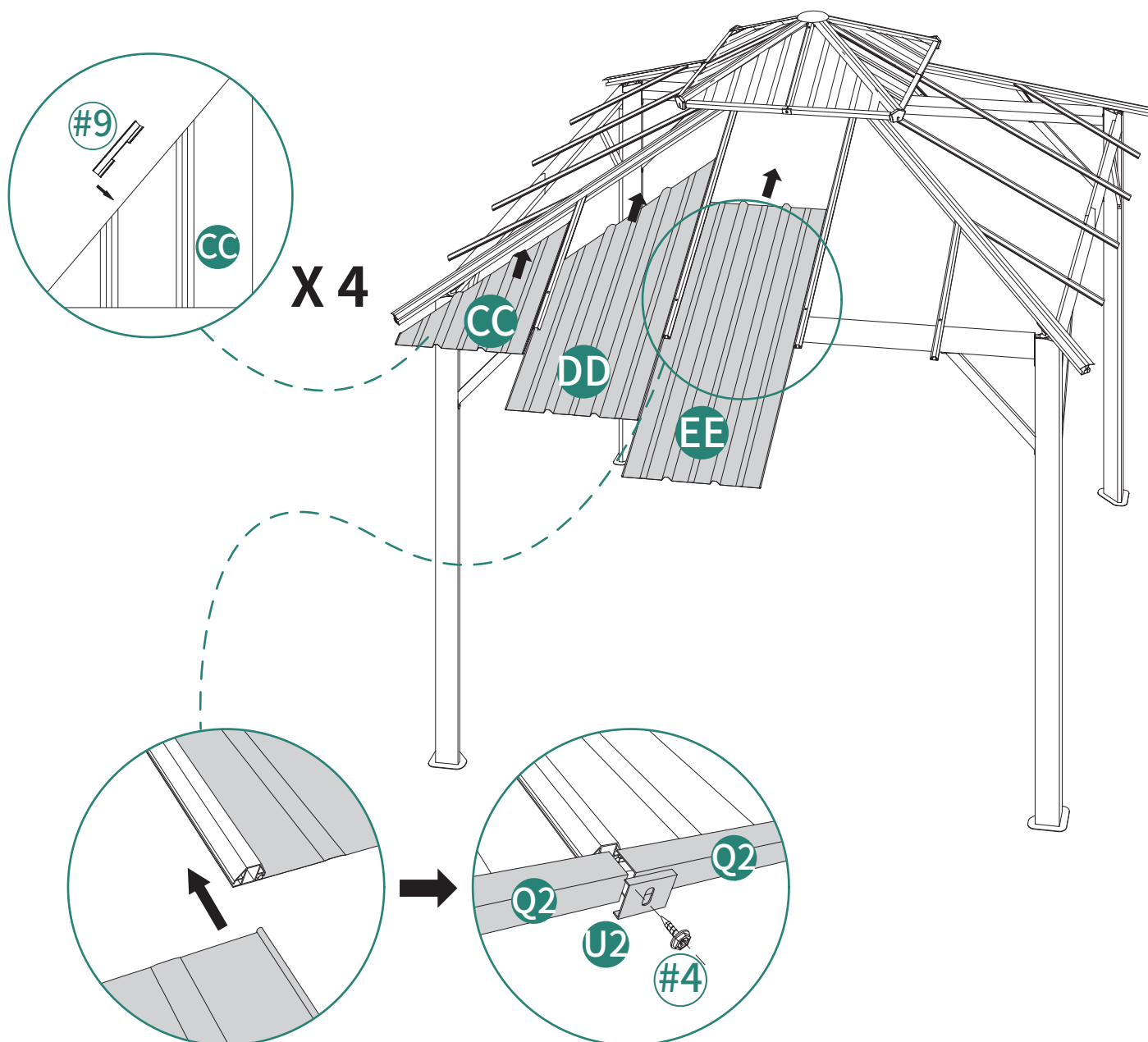

# 12

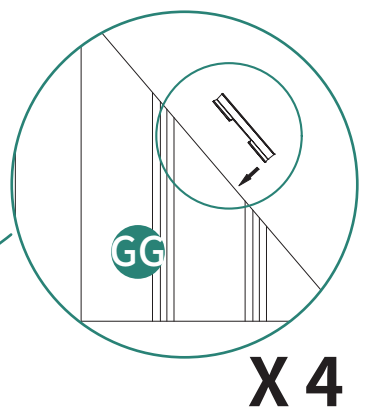
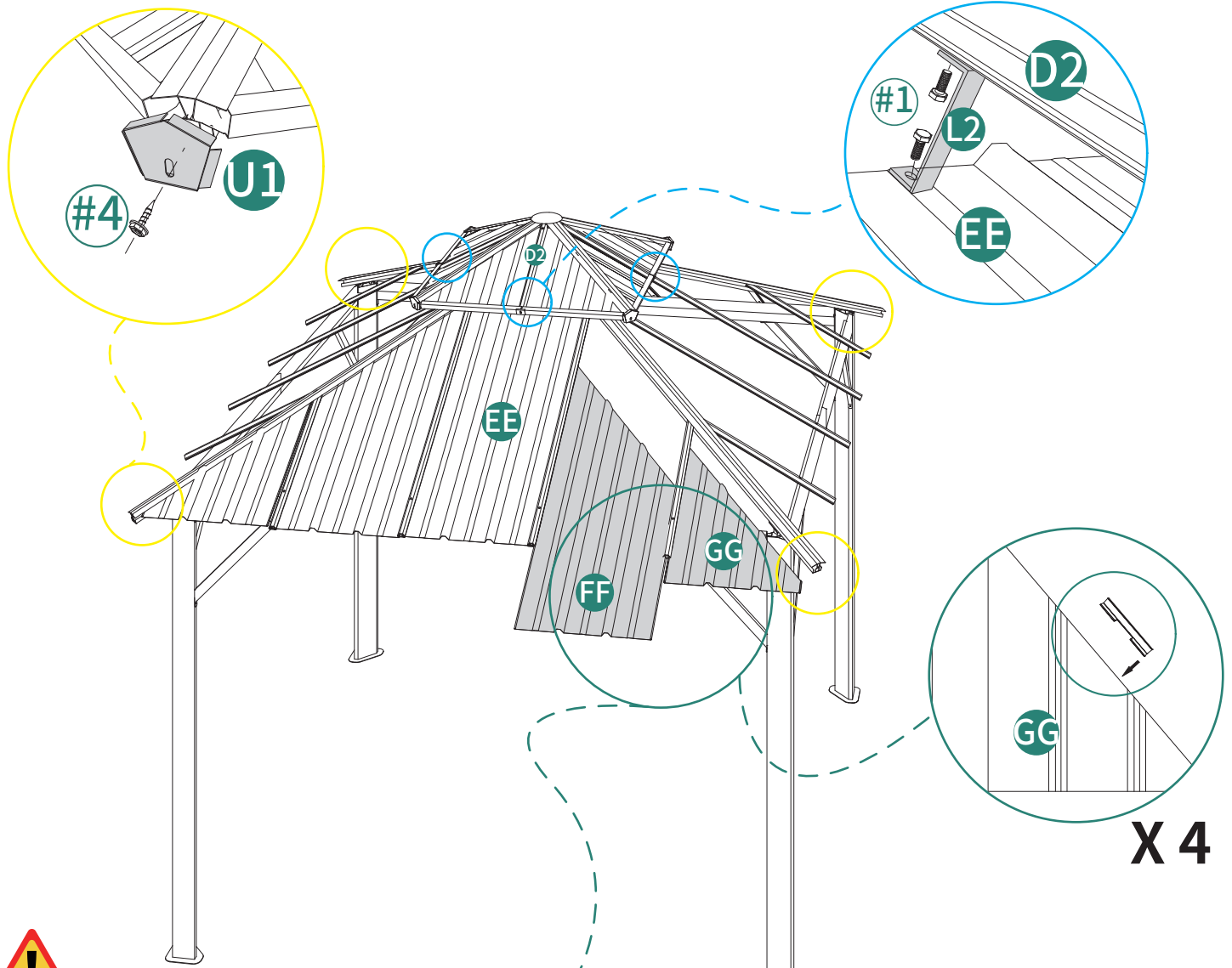
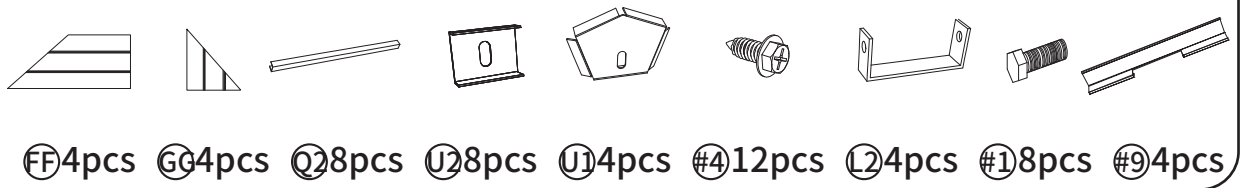

Start installation from a corner, then continue in a clockwise or counterclockwise direction to install the panels. Note that once a panel is installed, a corresponding edge trim needs to be attached and secured with screws to prevent any injury from falling panels.

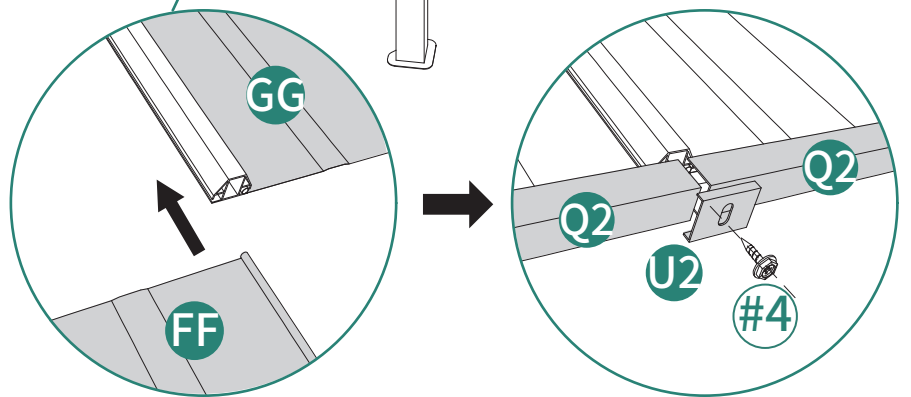

# 13

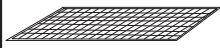

Ⓩ1pc



Ⓜ2pcs

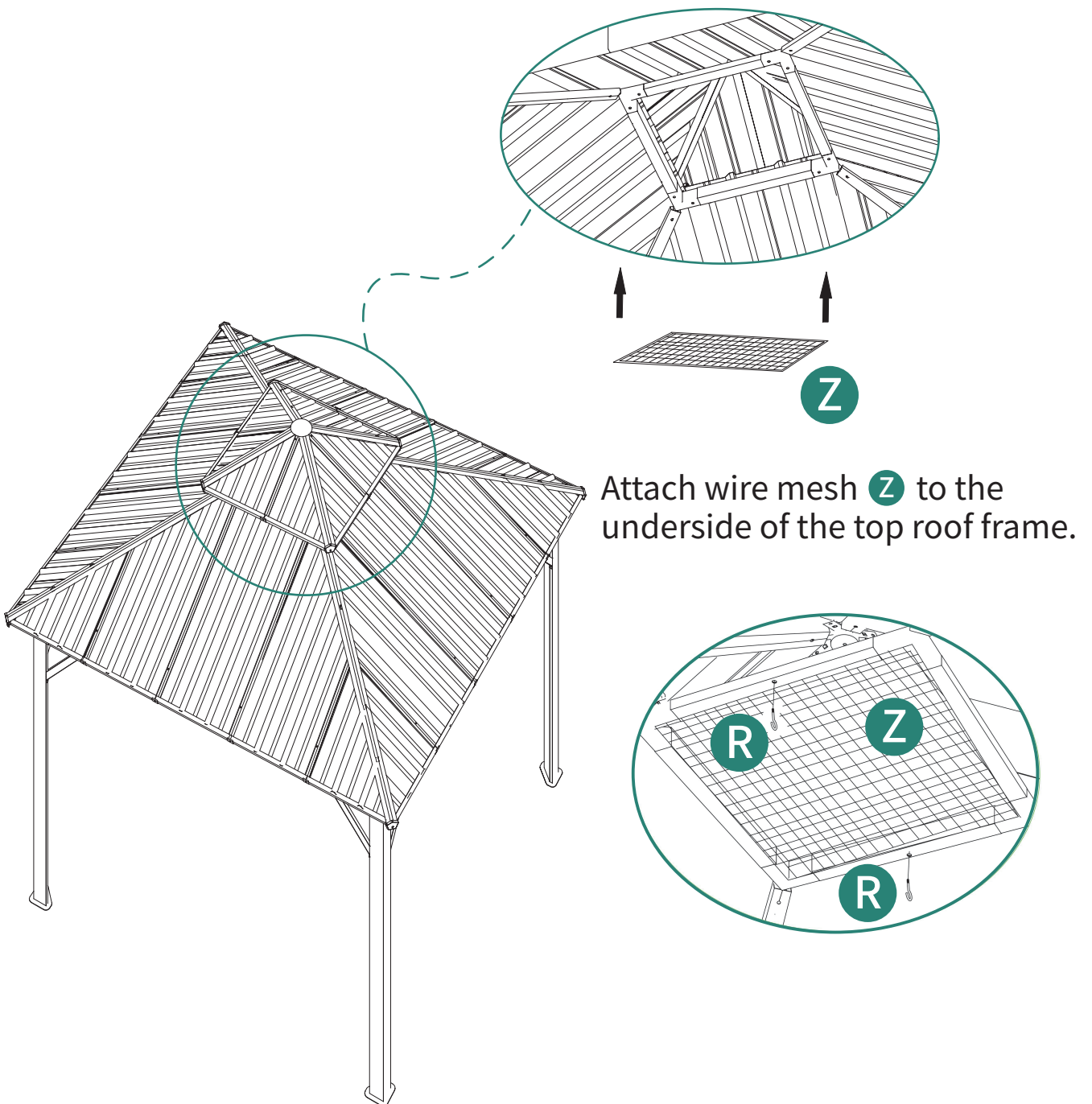

14

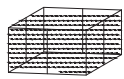

⊗ 1pc

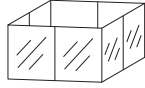

⊙ 1pc

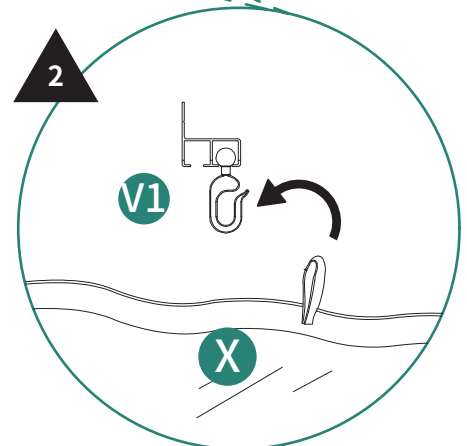
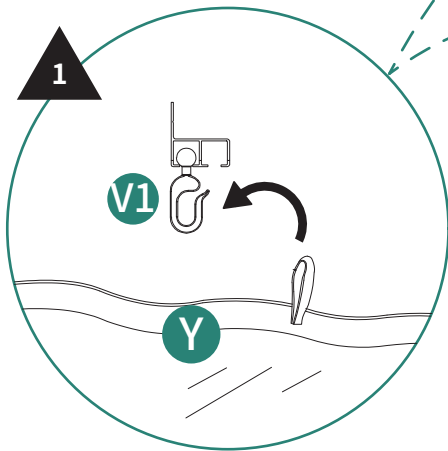
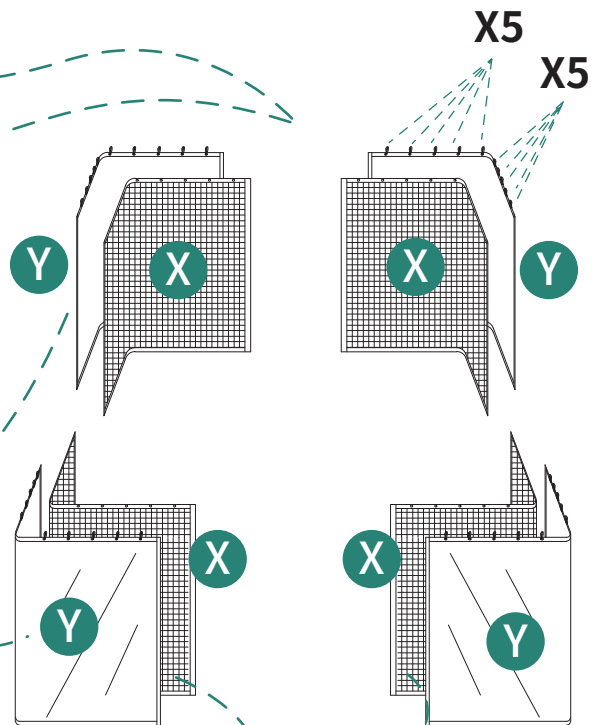
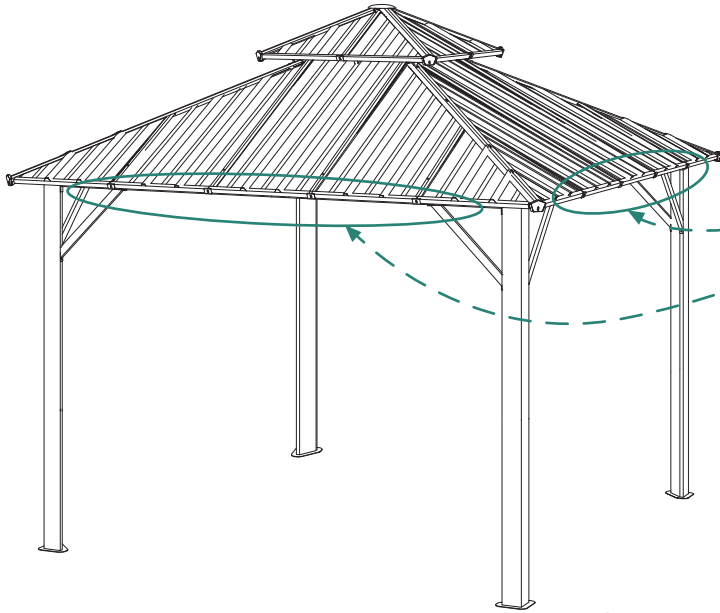

# 15

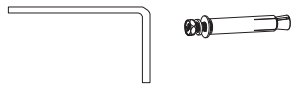

#5 12pcs #8 12pcs

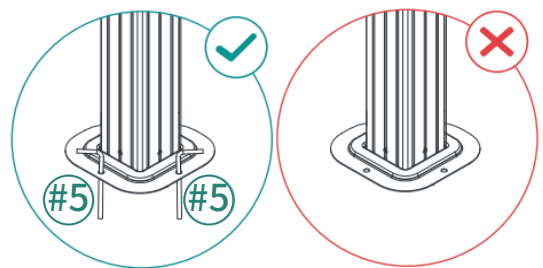
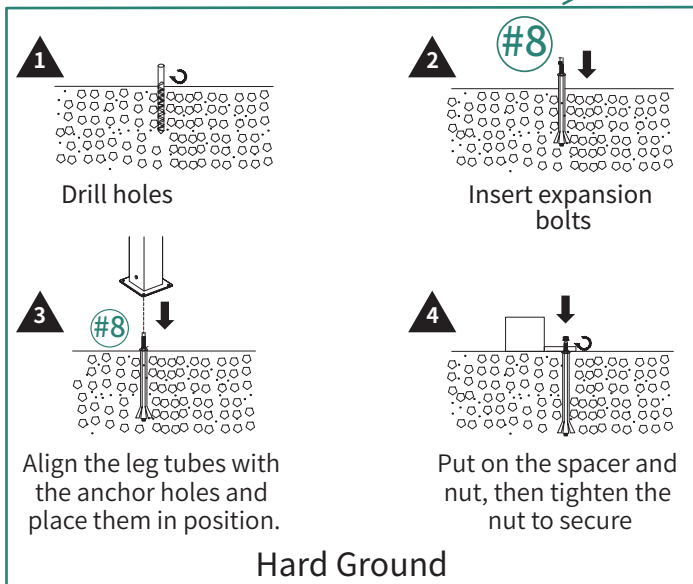
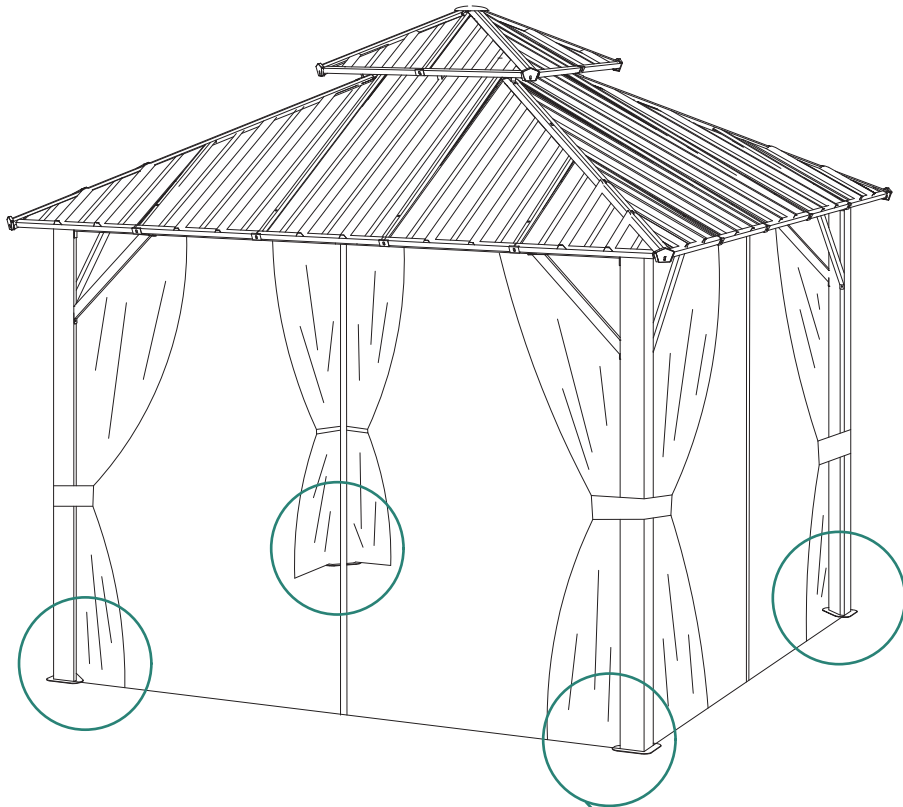

Soft Ground

# 16

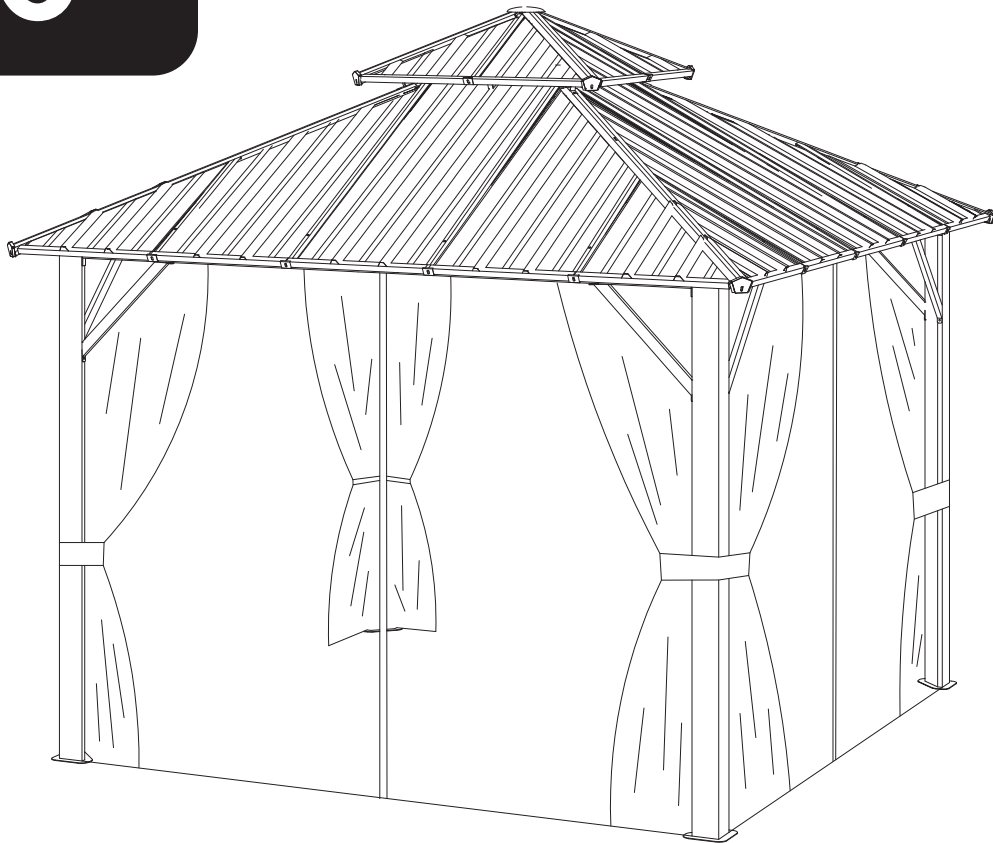

**1. The product must be installed on a solid base, such as cement or a floor, to prevent damage from strong winds and potential property or health risks.**

2. If the product cannot be securely fixed, you must detach and store it properly before heavy winds occur.

**3. The manufacturer will not be liable for any losses or damages if these instructions and recommendations are not followed.**

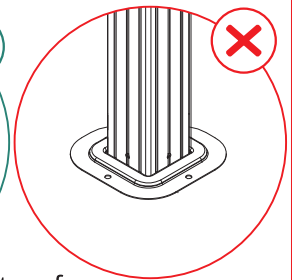
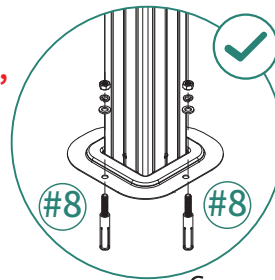

Cement surfaces

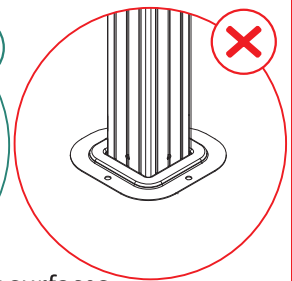
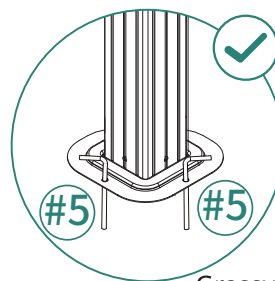

Grassy surfaces

17

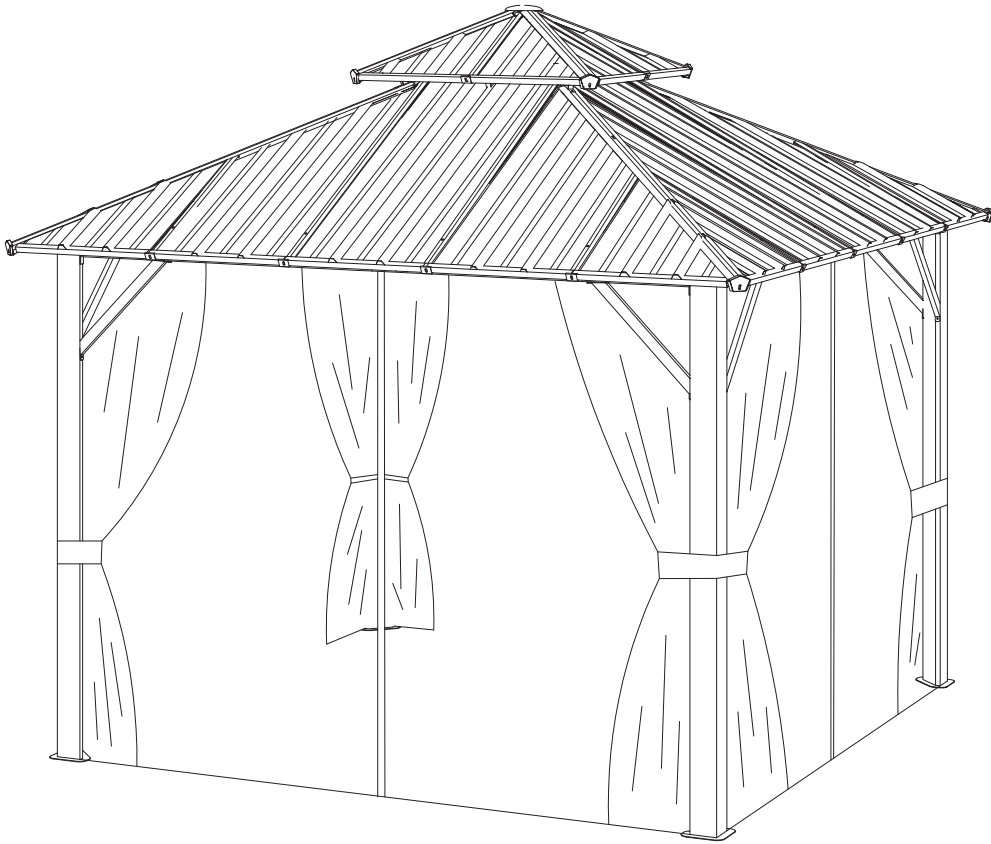

Installation Completed

Installation Abgeschlossen

Installation Complétée

Installazione Completata

Instalación Completada

# HELP CENTER



Inquiry



Assembly issue



Missing parts

If you encounter any difficulties during assembly, please contact us.

Wenn Sie während der Montage auf Schwierigkeiten stoßen, kontaktieren Sie uns bitte.

Si vous rencontrez des difficultés lors du montage, veuillez nous contacter.

Se incontri difficoltà durante il montaggio, ti preghiamo di contattarci.

Si encuentras alguna dificultad durante el ensamblaje, por favor contáctanos.

# DISCLAIMER

Manufacturer and seller expressly disclaim any and all liability for personal injury, property damage or loss, whether direct, indirect, or incidental, resulting from the incorrect attachment, improper use, inadequate maintenance, unapproved modification, or neglect of this product.

Der Hersteller und Verkäufer lehnen ausdrücklich jegliche Haftung für Personenschäden, Sachschäden oder Verluste ab, egal ob direkt, indirekt oder zufällig, die durch falsche Anbringung, unsachgemäßen Gebrauch, unzureichende Wartung, nicht genehmigte Änderungen oder Vernachlässigung dieses Produkts entstehen.

El fabricante y vendedor renuncian expresamente a toda responsabilidad por lesiones personales, daños materiales o pérdidas, ya sean directos, indirectos o incidentales, derivados de la incorrecta colocación, uso inadecuado, mantenimiento insuficiente, modificación no aprobada o negligencia de este producto.

Il produttore e il venditore declinano espressamente ogni responsabilità per lesioni personali, danni materiali o perdite, dirette, indirette o incidentali, derivanti dall'errato fissaggio, uso improprio, manutenzione inadeguata, modifica non autorizzata o negligenza di questo prodotto.

Le fabricant et le vendeur déclinent expressément toute responsabilité en cas de blessures corporelles, de dommages matériels ou de pertes, qu'ils soient directs, indirects ou accessoires, résultant de la fixation incorrecte, de l'utilisation inappropriée, de l'entretien insuffisant, de la modification non approuvée ou de la négligence de ce produit.