

ASSEMBLY INSTRUCTIONS

TEAKWOOD GARDEN BENCH (ATF60, ATF87)

PARTS

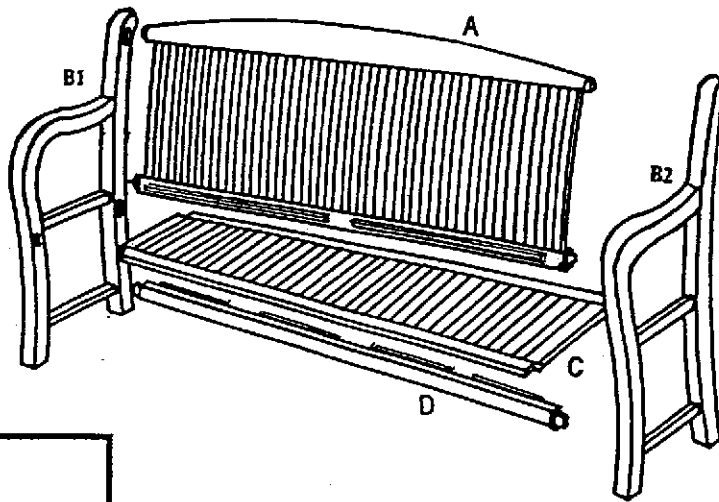

STEP 1

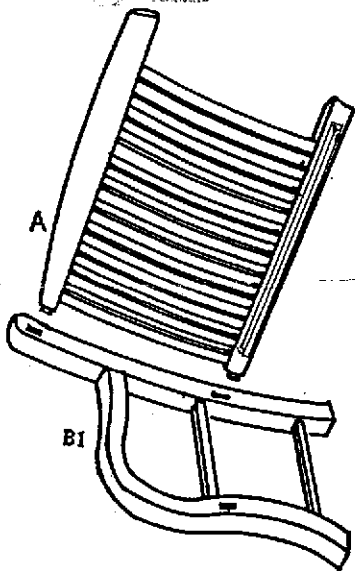

STEP 3

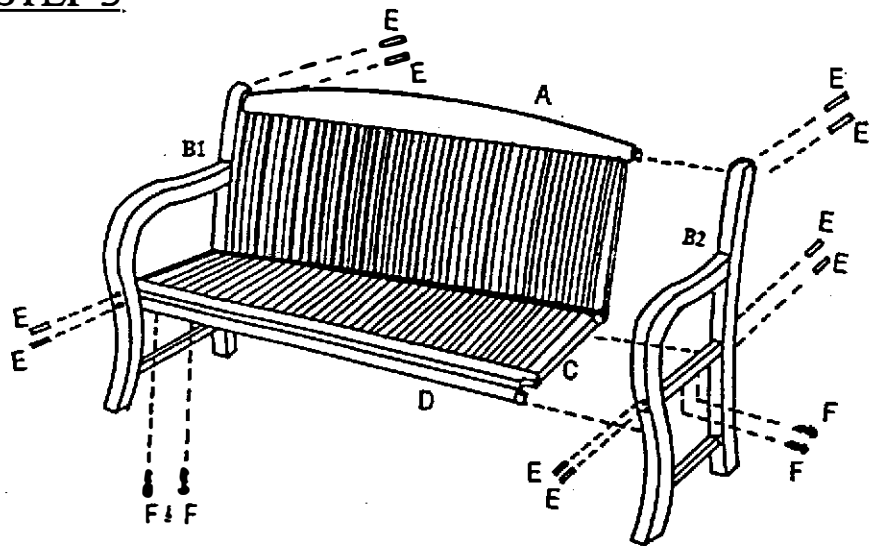

STEP 2

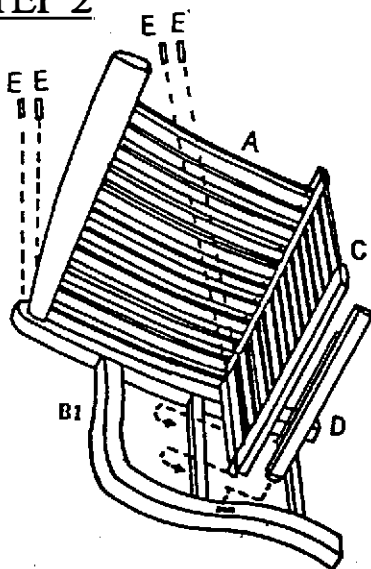

STEP 4

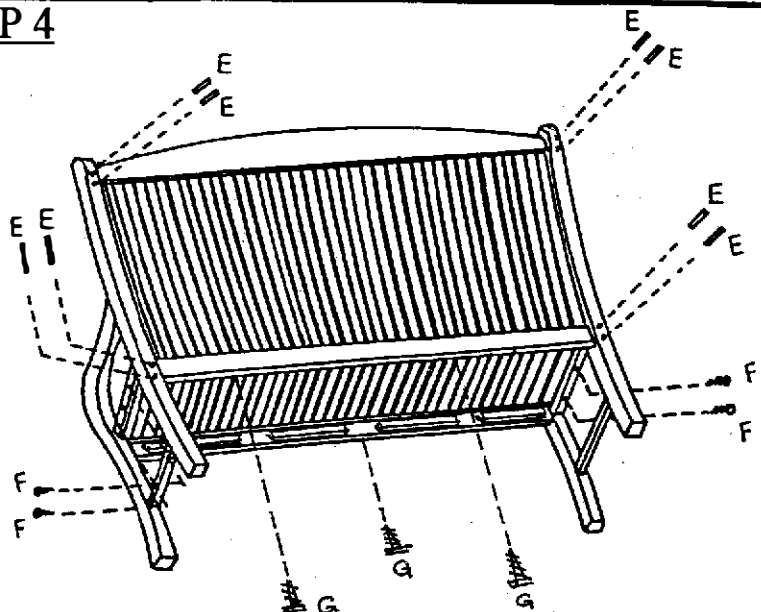

ASSEMBLY INSTRUCTIONS

TEAKWOOD GARDEN BENCH (ATF60, ATF87)

STEP 5-7.

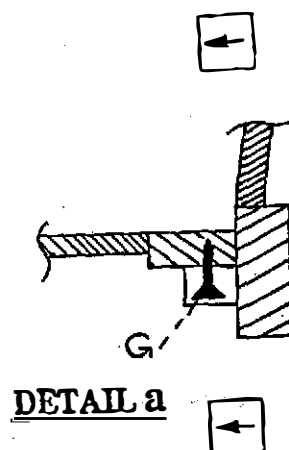
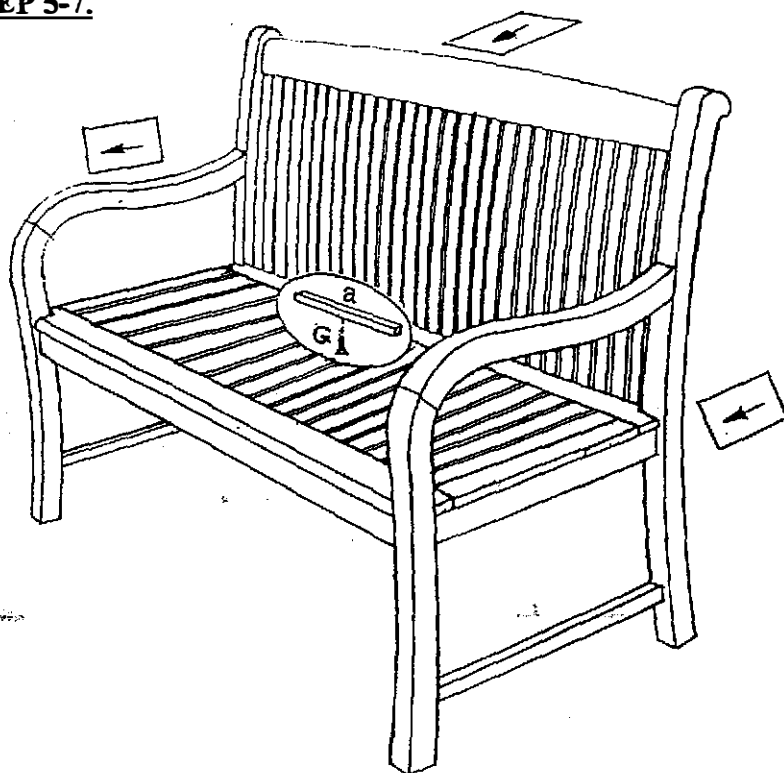

DETAIL a

PRESS BACKREST FIRMLY TO THE BACKSEAT
WHILE TIGHTENING THE SCREW (G)

Assembly instructions :







Unpack and lay parts on clean flat soft surface to avoid marring wood.

- Step 1 Lay the side frame (B1) on the floor . Insert the backrest (A) carefully into the side frame.
- Step 2 Insert seat (C) and front bar (D) carefully into the side frame as drawing of step 2.
- Step 3 With side frame (B1), backrest (A) seat (C) and front bar (D) now firmly in place on one side, put the other side frame (B2) onto the other side of (A) , (C) and (D)
- Step 4 Dip the wooden dowels (E) into glue and insert them into the 12 holes at the front legs and back legs as in drawing of step 4.
- Step 5 Press both side frame (B1) & (B2) tightly to the seat and tighten the long screws (F) from underneath at the specific holes.
- Step 6 Press the front cross bar up against the front seat and tighten up the short screws (G) from underneath.
- Step 7 Press the back of the backrest to the back of seat (C) and tighten up the short screw (G) from underneath.

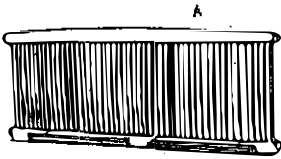
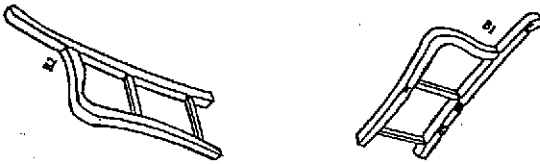
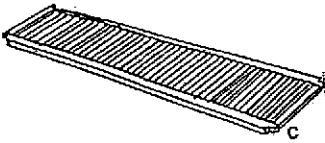
BE CAREFUL!!! Keep pressing the back of backrest close to the back seat while tightening up the screws.

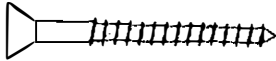
ASSEMBLY INSTRUCTIONS

TEAKWOOD GARDEN BENCH (GB-986-L)

NO.	PARTS	QTY.
A	BACKREST 	1
B1 B2	ARM-LEGS 	2
C	SEAT SLATS 	1
D	FRONT STRETCHER 	1
E	LONG DOWEL 	12 (2 EXTRAS)
F	SCREW LONG 	4+1
G	SCREW SHORT 	3+1
H	SANDPAPER 	1
I	GLUE 	1