

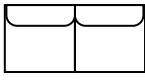









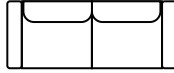



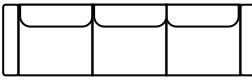



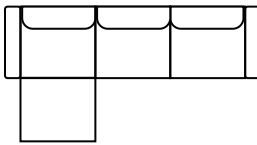





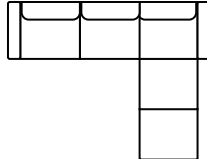



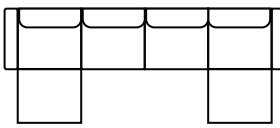

Assembly Manual

Modular Sofa



! Do not start the assembly process until all boxes are present.

<p>2-piece Armless</p> 	<p>Box × 2</p> <div style="display: flex; justify-content: space-around;"> <div data-bbox="392 215 492 279">  <p>Armless Chair</p> </div> <div data-bbox="537 215 638 279">  <p>Armless Chair</p> </div> </div>
<p>2-piece</p> 	<p>Box × 3</p> <div style="display: flex; justify-content: space-around;"> <div data-bbox="392 399 470 462">  <p>Arms</p> </div> <div data-bbox="509 406 621 470">  <p>Left Seat & Backrest</p> </div> <div data-bbox="672 406 784 470">  <p>Right Seat & Backrest</p> </div> </div>
<p>3-piece</p> 	<p>Box × 4</p> <div style="display: flex; justify-content: space-around;"> <div data-bbox="392 590 470 654">  <p>Arms</p> </div> <div data-bbox="509 598 621 662">  <p>Left Seat & Backrest</p> </div> <div data-bbox="672 598 784 662">  <p>Right Seat & Backrest</p> </div> <div data-bbox="840 598 946 662">  <p>Armless Chair</p> </div> </div>
<p>4-piece</p> 	<p>Box × 5</p> <div style="display: flex; justify-content: space-around;"> <div data-bbox="392 774 470 837">  <p>Arms</p> </div> <div data-bbox="509 782 621 845">  <p>Left Seat & Backrest</p> </div> <div data-bbox="672 782 784 845">  <p>Right Seat & Backrest</p> </div> <div data-bbox="828 782 946 845">  <p>Ottoman</p> </div> </div> <div style="display: flex; justify-content: space-around; margin-top: 10px;"> <div data-bbox="392 877 492 941">  <p>Armless Chair</p> </div> </div>
<p>5-piece</p> 	<p>Box × 6</p> <div style="display: flex; justify-content: space-around;"> <div data-bbox="392 1037 470 1101">  <p>Arms</p> </div> <div data-bbox="509 1045 621 1109">  <p>Left Seat & Backrest</p> </div> <div data-bbox="672 1045 784 1109">  <p>Right Seat & Backrest</p> </div> <div data-bbox="845 1045 952 1109">  <p>Armless Chair</p> </div> </div> <div style="display: flex; justify-content: space-around; margin-top: 10px;"> <div data-bbox="392 1141 509 1204">  <p>Ottoman</p> </div> <div data-bbox="537 1141 655 1204">  <p>Ottoman</p> </div> </div>
<p>6-piece</p> 	<p>Box × 7</p> <div style="display: flex; justify-content: space-around;"> <div data-bbox="392 1300 470 1364">  <p>Arms</p> </div> <div data-bbox="509 1308 621 1372">  <p>Left Seat & Backrest</p> </div> <div data-bbox="672 1308 784 1372">  <p>Right Seat & Backrest</p> </div> </div> <div style="display: flex; justify-content: space-around; margin-top: 10px;"> <div data-bbox="392 1404 492 1468">  <p>Armless Chair</p> </div> <div data-bbox="537 1404 638 1468">  <p>Armless Chair</p> </div> <div data-bbox="677 1404 795 1468">  <p>Ottoman</p> </div> <div data-bbox="828 1404 946 1468">  <p>Ottoman</p> </div> </div>

Assembly Manual

Left Armchair



Parts

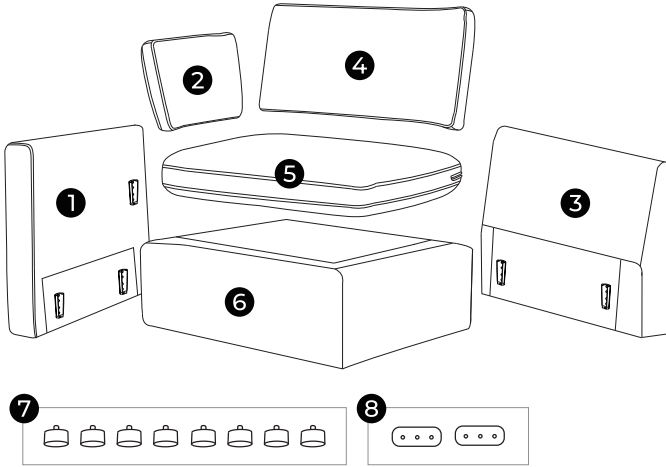

- ① Left Arm
- ② Arm Pillow
- ③ Left Backrest
- ④ Back Cushion
- ⑤ Seat Cushion
- ⑥ Left Seat Base
- ⑦ Leg × 8
- ⑧ Connector x 2

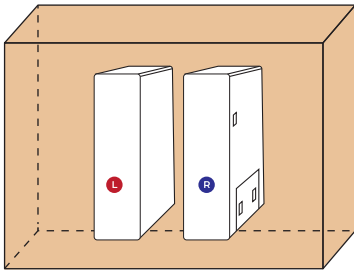

Note: Left & Right Arms are packed together in Arms Box.



Arms PIECES INCLUDED

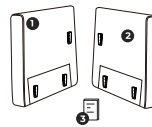

- ① Left Arm x 1
- ② Right Arm x 1
- ③ Assembly Manual x 1

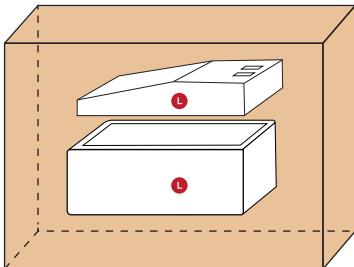

Left Seat & Backrest PIECES INCLUDED

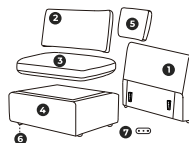

- ① Backrest x 1
- ② Back Cushion x 1
- ③ Seat Cushion x 1
- ④ Seat Base x 1
- ⑤ Arm Pillow x 1
- ⑥ Leg x 8
- ⑦ Connector x 2

Left Armchair

Step 1

Take out the Left Arm (L) from Arms Box.

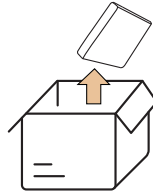
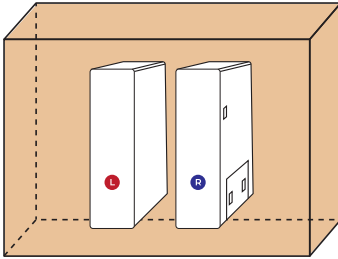

Step 2

Take out the Left Seat and Backrest from Left Seat & Backrest Box.

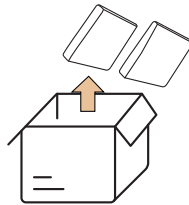
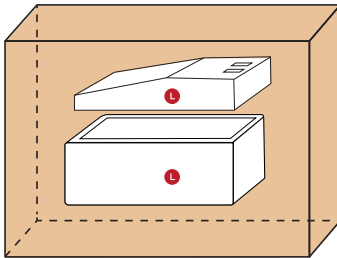

Step 3

Remove the three wood sticks at the base of the seat to take out the Seat Cushion, Back Cushion, Arm Pillow, and Metal Connectors (2 pieces). ⚠ Remove the sticks one by one. Push the stick down and rotate it towards the corner of the base and pull it out. Once all sticks are out, take out the cushions carefully.

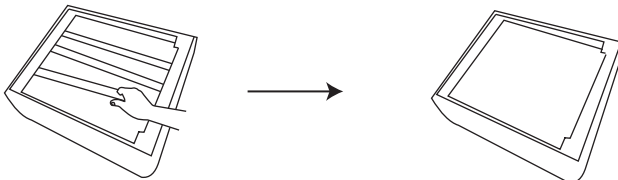

Left Armchair

Step 4

Take out the Legs (8 pieces) from the bottom of the Backrest.

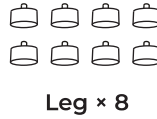
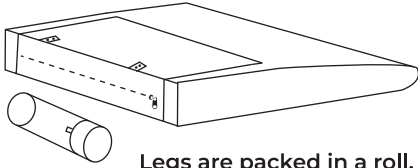

Step 5

Rotate the Legs firmly.

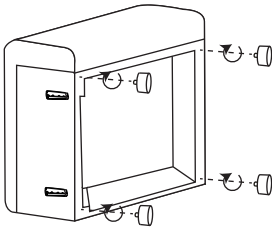

Left Seat

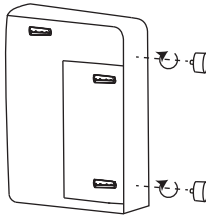

Left Arm

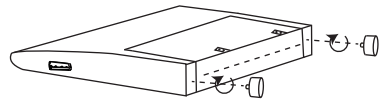

Left Backrest

Step 6

Slide the Left Backrest into the Left Seat.

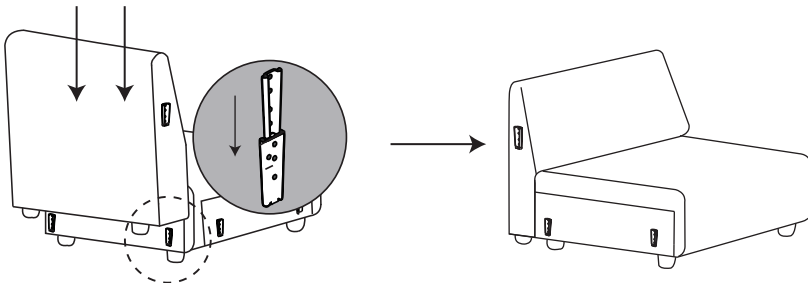

Left Armchair

Step 7

Slide the Left Arm into the Left Seat and Backrest.

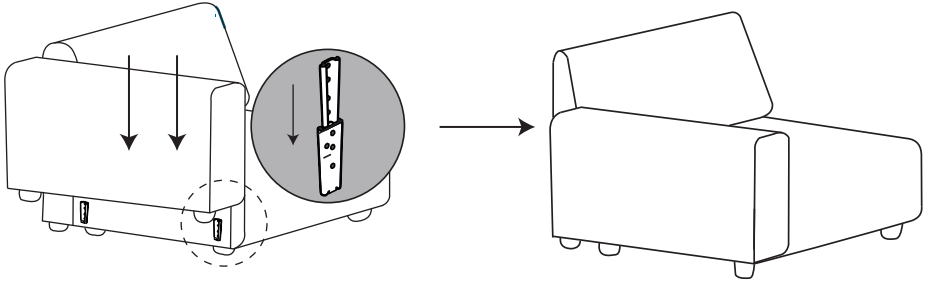

Step 8

Fluff the Seat Cushion, Back Cushion, and Arm Pillow, and put them on the chair to complete the assembly of your Left Armchair.

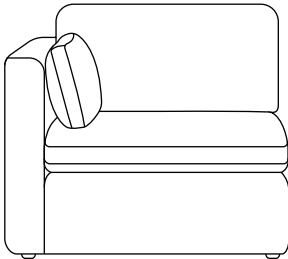

Congratulations!
Left Armchair is ready!

Tips

For now, please keep the Metal Connectors aside and you may need them after you have completed the assembly of all modules (See Page 18 to 20 for details).

Right Armchair



Parts

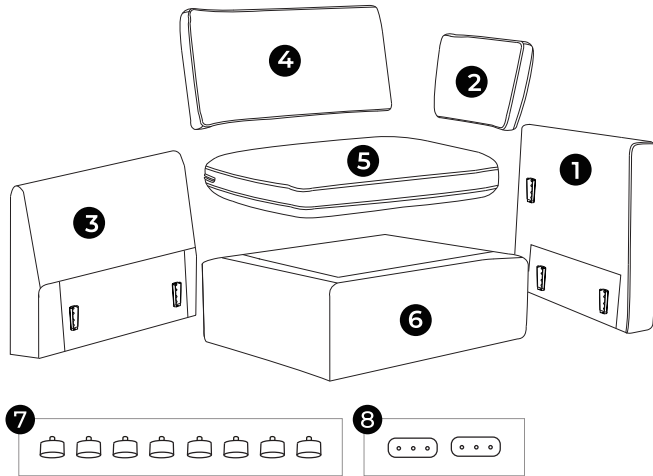

- 1 Right Arm
- 2 Arm Pillow
- 3 Right Backrest
- 4 Back Cushion
- 5 Seat Cushion
- 6 Right Seat Base
- 7 Leg × 8
- 8 Connector × 2

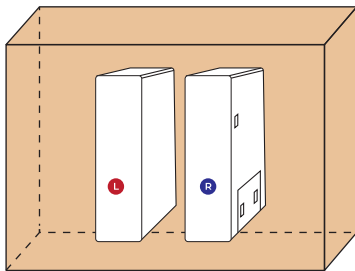

Arms PIECES INCLUDED

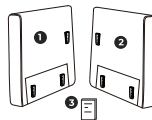

- 1 Left Arm x 1
- 2 Right Arm x 1
- 3 Assembly Manual x 1

Note: Left & Right Arms are packed together in Arms Box.

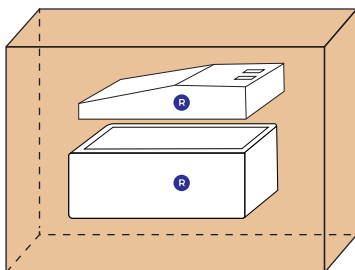

Right Seat & Backrest PIECES INCLUDED

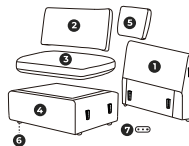

- 1 Backrest x 1
- 2 Back Cushion x 1
- 3 Seat Cushion x 1
- 4 Seat Base x 1
- 5 Arm Pillow
- 6 Leg x 8
- 7 Connector x 2

Right Armchair

Step 1

Take out the Right Arm (R) from Arms Box.

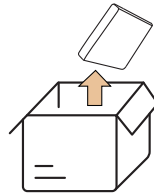
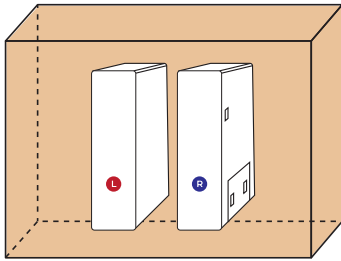

Step 2

Take out the Right Seat and Backrest from Right Seat & Backrest Box.

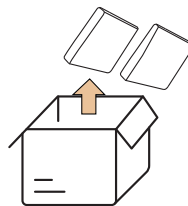
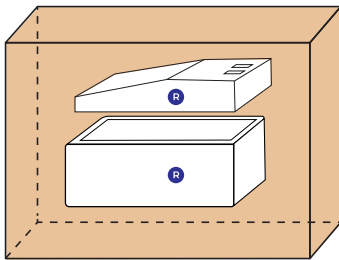

Step 3

Remove the three wood sticks at the base of the seat to take out the Seat Cushion, Back Cushion, Arm Pillow, and Metal Connectors (2 pieces). ⚠ Remove the sticks one by one. Push the stick down and rotate it towards the corner of the base and pull it out. Once all sticks are out, take out the cushions carefully.

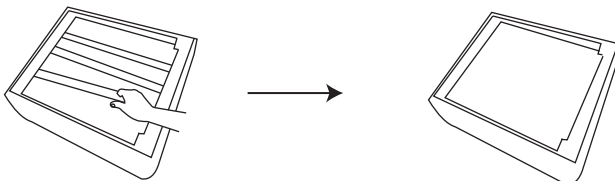

Right Armchair

Step 4

Take out the Legs (8 pieces) from the bottom of the Backrest.

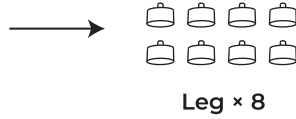
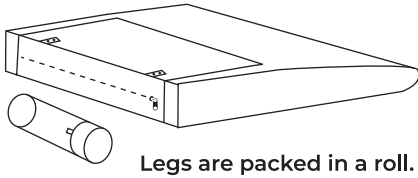

Step 5

Rotate the Legs firmly.

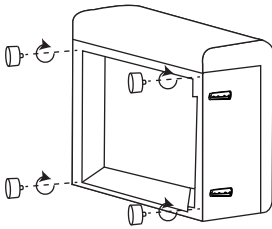

Right Seat

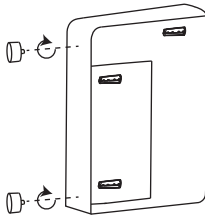

Right Arm

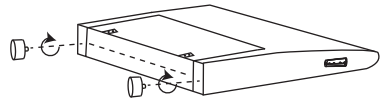

Right Backrest

Step 6

Slide the Right Backrest into the Right Seat.

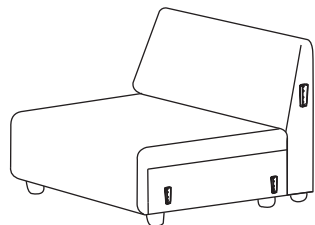
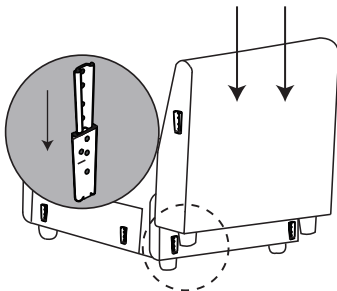

Right Armchair

Step 7

Slide the Right Arm into the Right Seat and Backrest.

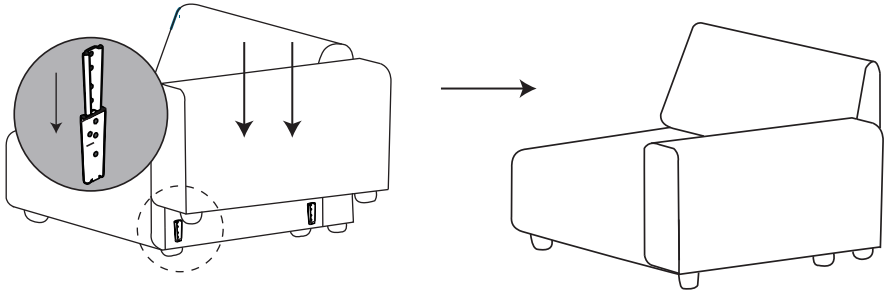

Step 8

Fluff the Seat Cushion, Back Cushion, and Arm Pillow, and put them on the chair to complete the assembly of your Right Armchair.

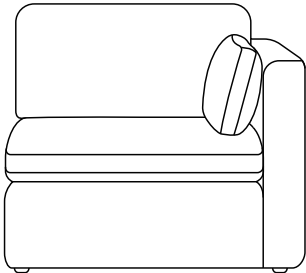

Congratulations!
Right Armchair is ready!

Tips

For now, please keep the Metal Connectors aside and you may need them after you have completed the assembly of all modules (See Page 18 to 20 for details).

Assembly Manual

Armless Chair



Parts

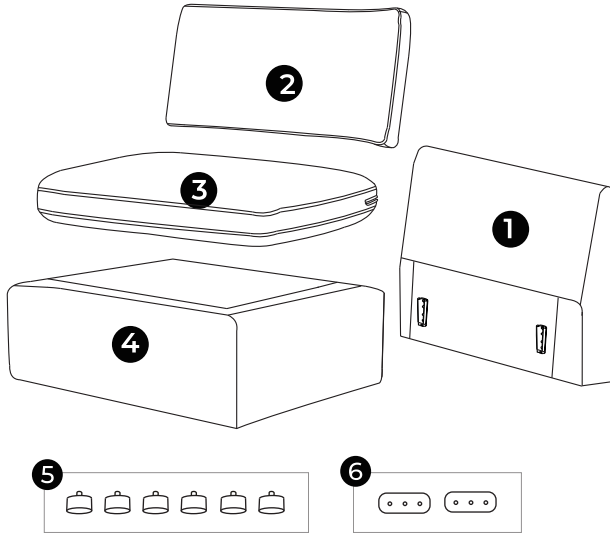

- ① Backrest
- ② Back Cushion
- ③ Seat Cushion
- ④ Seat Base
- ⑤ Leg × 6
- ⑥ Connector x 2

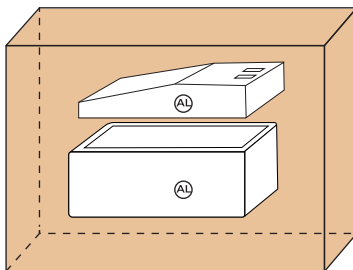

Armless Chair PIECES INCLUDED

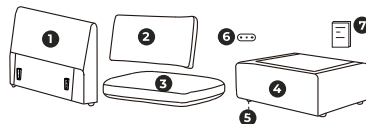

- ① Backrest x 1
- ② Back Cushion x 1
- ③ Seat Cushion x 1
- ④ Seat Base x 1
- ⑤ Leg x 6
- ⑥ Connector x 2
- ⑦ Assembly Manual x 1

Assembly Manual

Armless Chair

Step 1

Take out the Seat and Backrest from Armless Box.

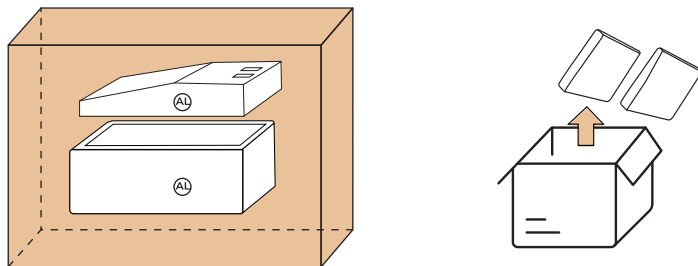

Step 2

Remove the three wood sticks at the base of the seat to take out the Seat Cushion, Back Cushion, and Metal Connectors (2 pieces).

- ⚠ Remove the sticks one by one. Push the stick down and rotate it towards the corner of the base and pull it out. Once all sticks are out, take out the cushions carefully.

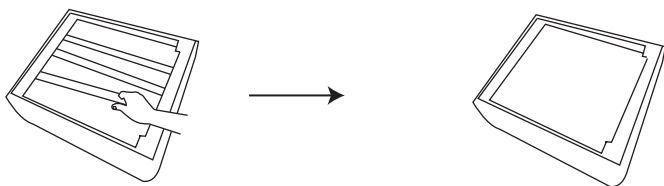

Step 3

Take out the Legs (6 pieces) from the bottom of the Backrest.

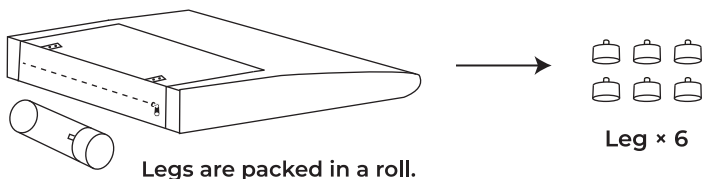

Assembly Manual

Armless Chair

Step 4

Rotate the Legs firmly.

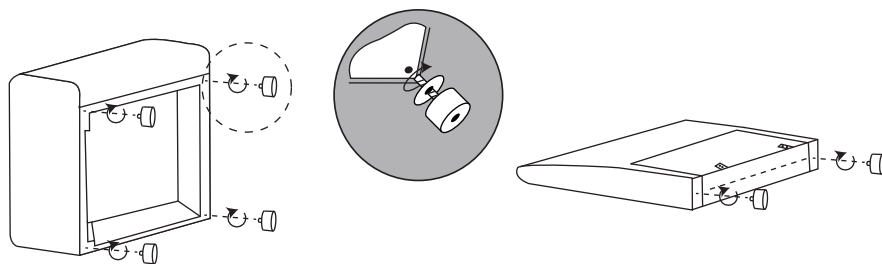

Seat Base

Backrest

Step 5

Slide the Backrest into the Seat.

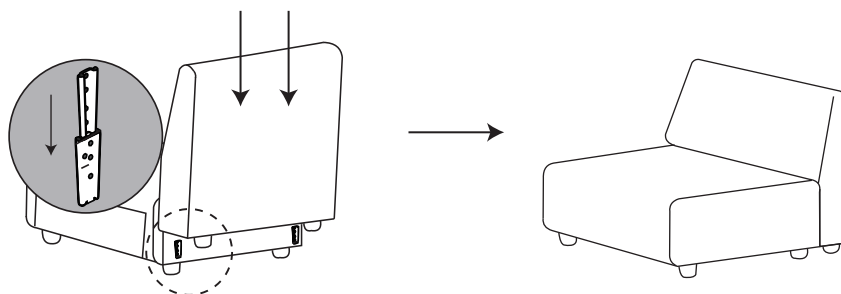

Armless Chair

Step 6

Fluff the Seat Cushion and Back Cushion. Put them on the chair to complete the assembly of your Armless Chair.

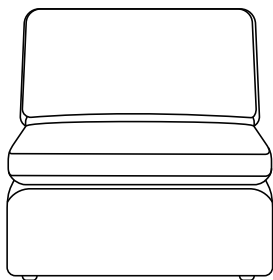

Congratulations!
Armless Chair is ready!

Tips

For now, please keep the Metal Connectors aside and you may need them after you have completed the assembly of all modules (See page 18 to 20 for details).

Ottoman



Parts

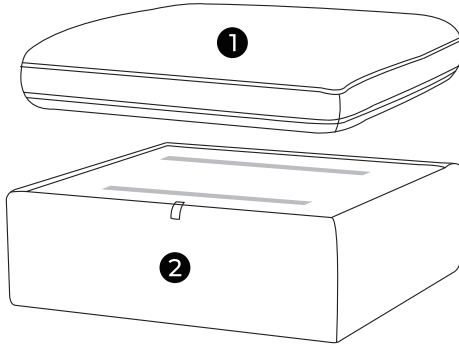

1 Seat Cushion

2 Seat Base

3 Leg x 4

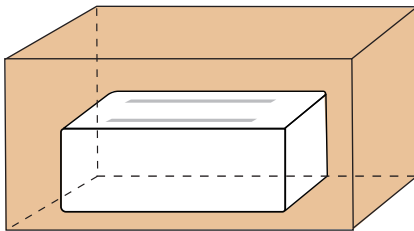

Ottoman PIECES INCLUDED

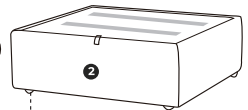
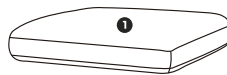

1 Seat Cushion x 1

2 Seat Base x 1

3 Leg x 4

4 Assembly Manual x 1

Ottoman

Step 1

Take out the Seat Base from Ottoman Box.

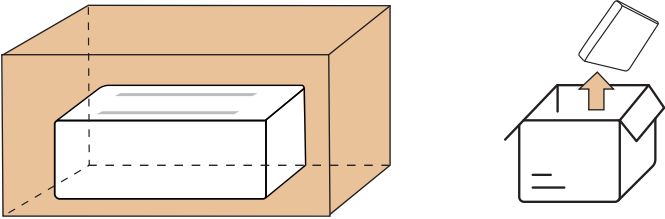

Step 2

Lift up the lid of the storage to take out Seat Cushion and Legs (4 pieces).

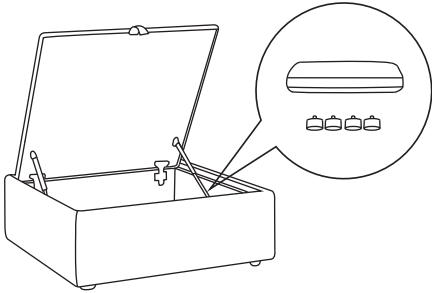

Step 3

Rotate the Legs firmly.

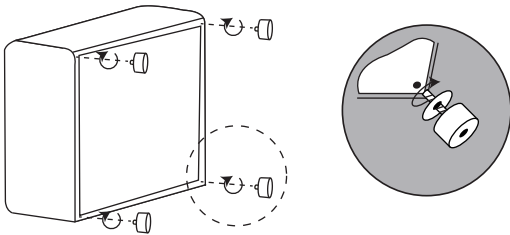

Ottoman

Step 4

Remove the velcro protectors on the top of the Seat.

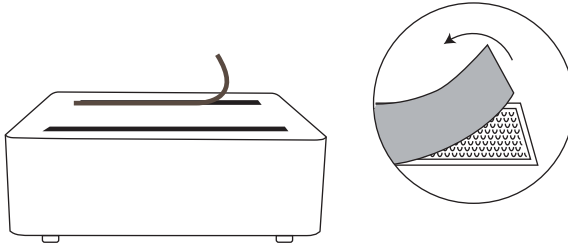

Step 5

Fluff the Seat Cushion. Attach it to the Seat Base to complete the assembly of your Ottoman.

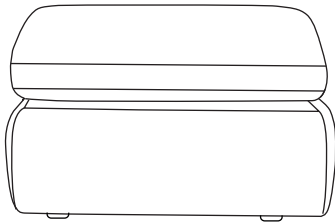

Congratulations!
Ottoman is ready!

Bonus Feature

Now you have successfully completed the assembly of each module. Based on the number of modules you purchased, you may remix your Delaney in multiple configurations. In the diagrams on following pages, there are several configurations for your reference. After you decide which configuration you love the most, you may connect the chairs with Metal Connectors. In addition to non-slip legs, these Metal Connectors are provided to further help prevent the chairs from sliding apart.

Step 1: Put the chairs side by side, with the base of the chair facing you.

Step 2: Attach the Metal Connectors by screwing on the legs firmly. You may have a few extra Metal Connectors left over. They are included in case you want to connect additional modules in the future. We recommend storing them in the little zip-top bag in case you decide to expand your Delaney later.

Note: Ottoman is a standalone piece and cannot be attached to any chair with Metal Connectors.

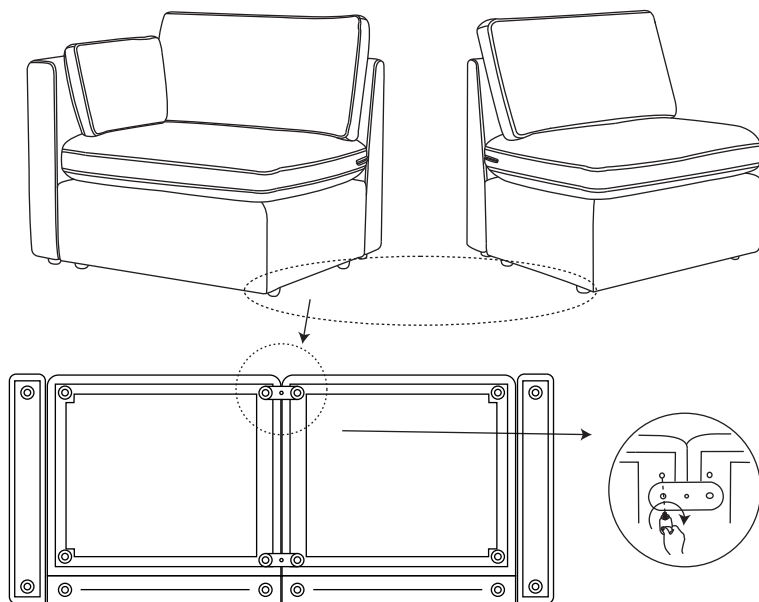

Modular Sofa

Multiple Configurations

2-piece Armless



W 68" x D 33" x H 35"

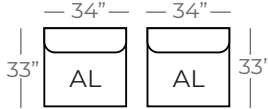

2-piece Sofa



W 78" x D 33" x H 35"

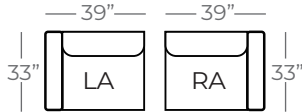

3-piece Sofa



W 112" x D 33" x H 35"

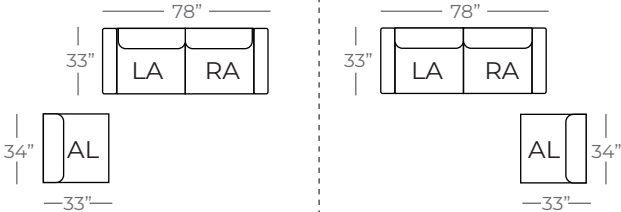

4-piece Sofa-Chaise



W 112" x D 66" x H 35"

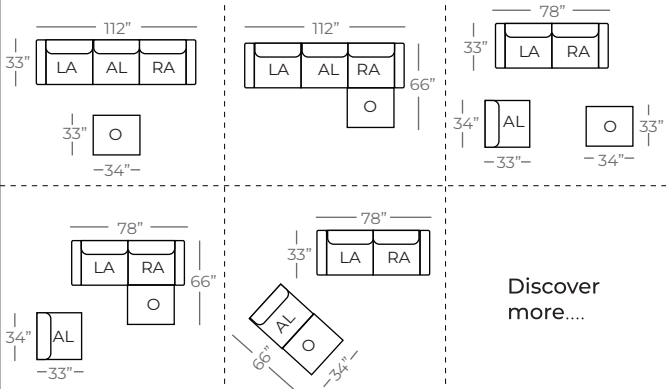

Discover more....

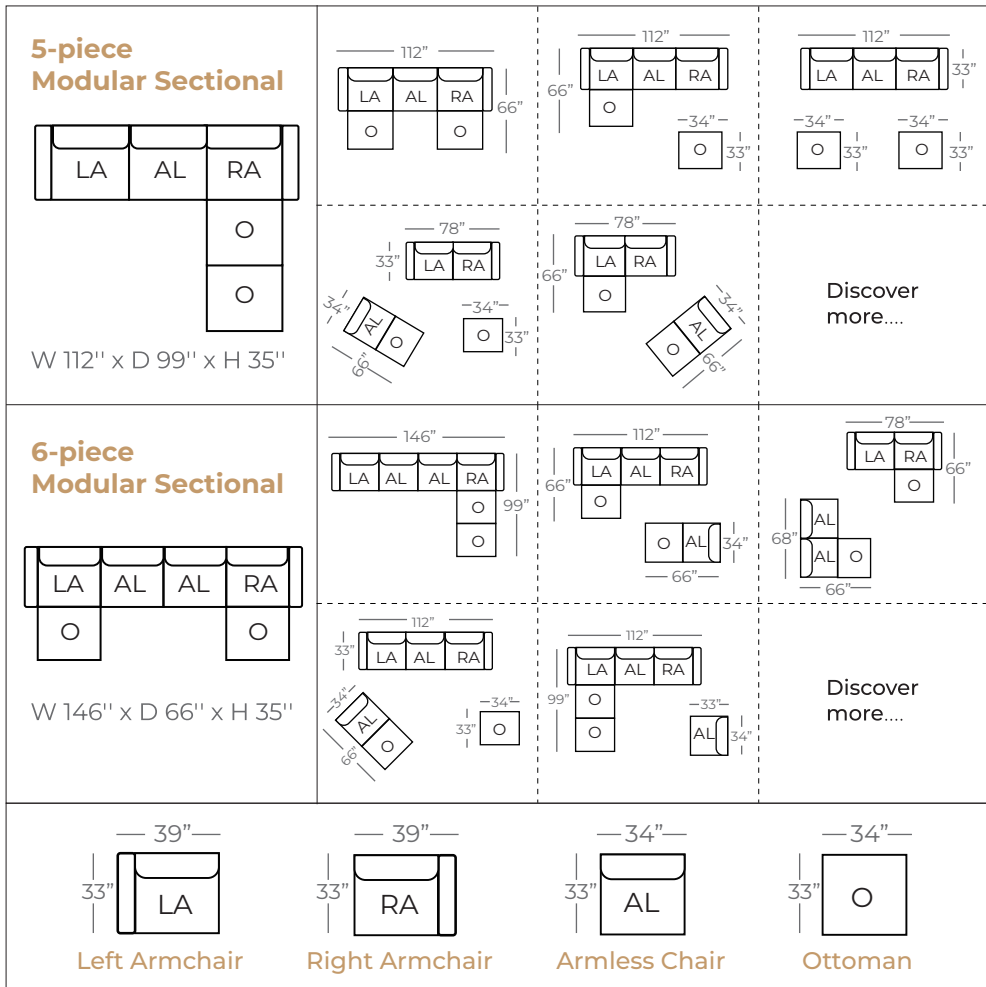

Care Instruction

For non-removable areas:

Blot and spot clean immediately with a clean, absorbent cloth and a water-free stain remover (Cleaning Code: S).

For cushion covers:

- Ⓟ Dry clean only.
- ☒ Do not tumble dry.
- ☒ Do not bleach.
- ☒ Iron at low temperature (230°F / 110°C or below).