

ASSEMBLY INSTRUCTIONS

BED - TWIN

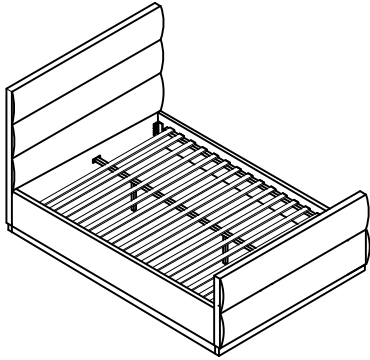

+ Do Not Use Power Tools



+ Suggested Adults

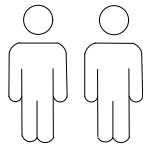

NOTE :

- 1 Read instructions cover to cover.
- 2 Save all packaging until assembly is completed.

1 IMPORTANT SAFETY INFORMATION

Do not assemble the product if any of the following parts arrived damaged:

- Part #③ -Side Rails
- Part #④ -Slats joint
- Part #⑤ -Center Support Bar
- Part #⑥ -Support Legs

2 IMPORTANT ASSEMBLY INFORMATION

Assembly Step ② Ensure the side rail bracket is fully hooked onto bolt **A** loosely threaded with both washers on the **OUTSIDE** of the bracket first, then proceed to fully tightening all 4 corners.

*Slats come packed in the bottom of headboard carton.

+ Parts Included

① Head Board (1pc)

② Foot Board (1pc)

③ Side Rails (2pcs)

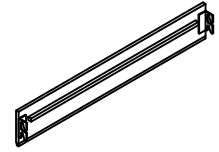
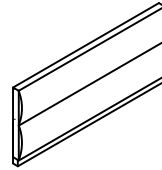
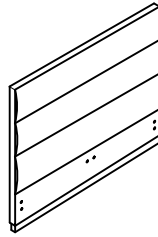

④ Slats joint (1set=13pcs)

⑤ Center Support Bar (1pc)

⑥ Support Legs (2pcs)

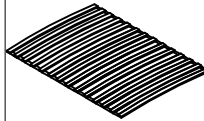

*Slats come packed in the bottom of headboard carton.

⑦ Head board Legs (2pcs)

⑧ Foot board Legs (1pc)

⑨ Side Rails Legs (2pcs)

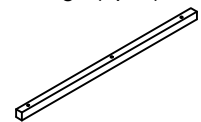

+ Hardware Included

A Bolt M8*35mm (16pcs)

B Nut M8*13mm (4pcs)

C Spanner (1pc)



D Spring Washer (8pcs)

E Flat Washer $\phi 20$ (28pcs)

F M8 Allen Key (1pc)



G Bolt M8*115mm (12pcs)



ASSEMBLY INSTRUCTIONS BED - TWIN

