

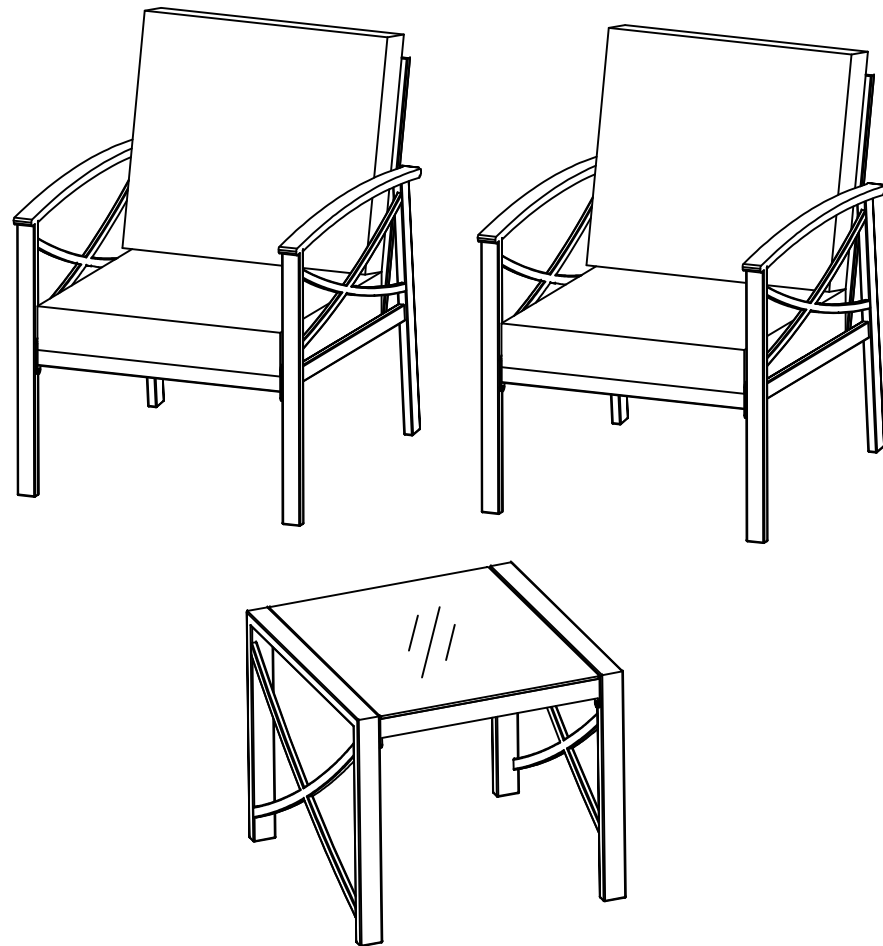

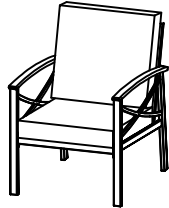

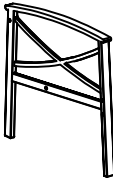

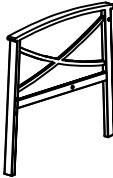

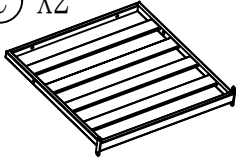
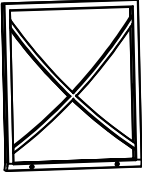

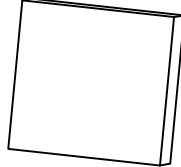





Instruction Manual



 <p>SINGLE CHAIR X2</p>		
<p>Ⓐ X2</p>  <p>LEFT</p>	<p>Ⓑ X2</p>  <p>RIGHT</p>	<p>Ⓒ X2</p> 
<p>Ⓓ X2</p> 	<p>Ⓔ X2</p> 	<p>Ⓕ X2</p> 
<p>① X8</p>  <p>M6x15mm</p>	<p>② X4</p>  <p>M6x25mm</p>	<p>③ X4</p>  <p>M6x35mm</p>
<p>④ X24</p> 	<p>⑤ X1</p> 	<p>⑥ X4</p>  <p>M6x45mm</p>
<p>⑦ X4</p>  <p>Nut</p>	<p>⑧ X1</p> 	

Thank you for shopping with us!
 We appreciate your purchase and are ready to be at your service!
 Be sure to check all the parts are included according to the instructions.
 Some of the hardware are small and may be hidden somewhere in the box or under the big parts.
 If you find them missing, we appreciate you can check again.
 Issues like parts missing, parts damaged or assembly difficulties, please contact us for efficient assistance.

1

Ⓒ		X1
Ⓓ		X1
④		X4
⑥		X2
⑦		X2

x2

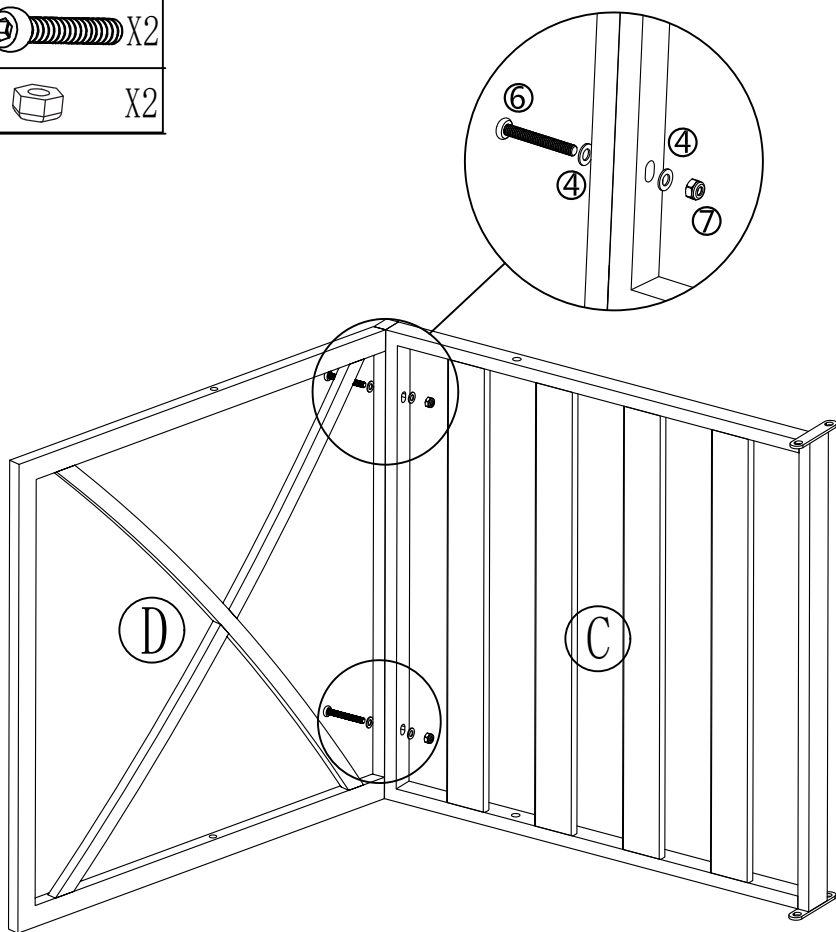







Note: During the assembly, please first half-tighten all the screws into the holes. After all the screws are set, fully tighten them.

EN

3

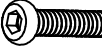
2

Ⓐ		X1 LEFT
Ⓑ		X1 RIGHT
①		X4
②		X2
③		X2
④		X8

x2

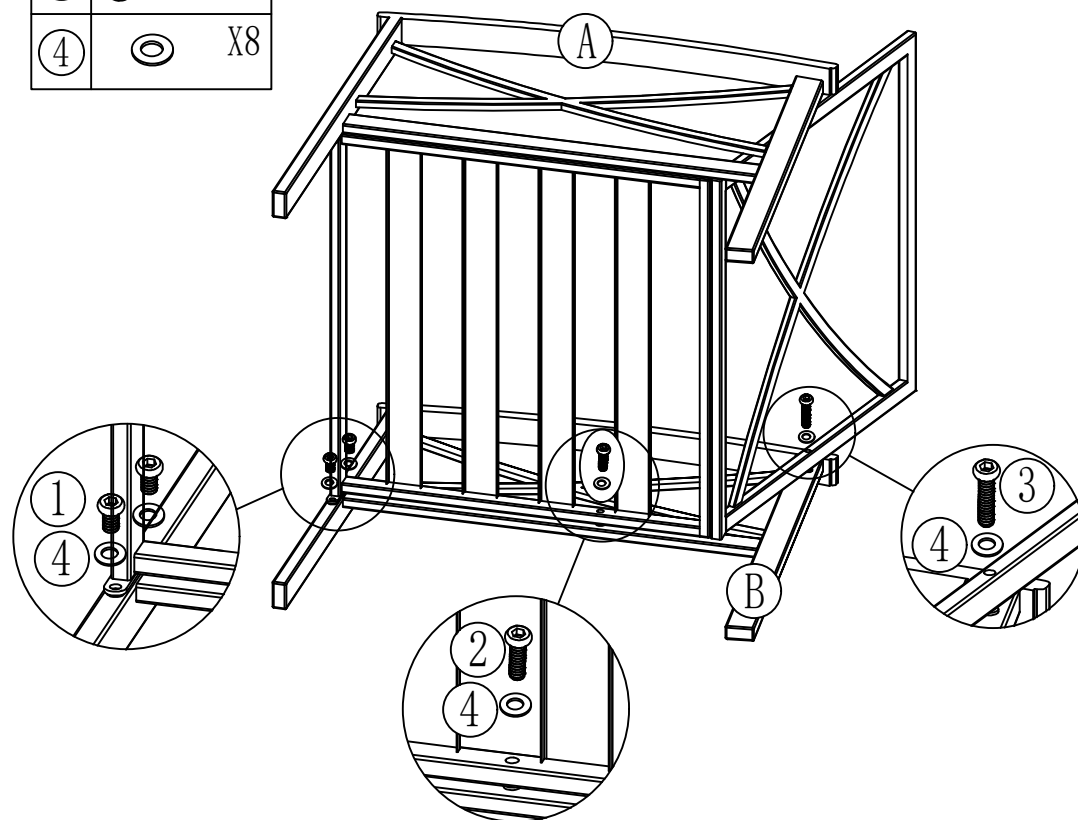



Note: During the assembly, please first half-tighten all the screws into the holes. After all the screws are set, fully tighten them.

EN

4

3

ⓔ		X1
ⓕ		X1

x2

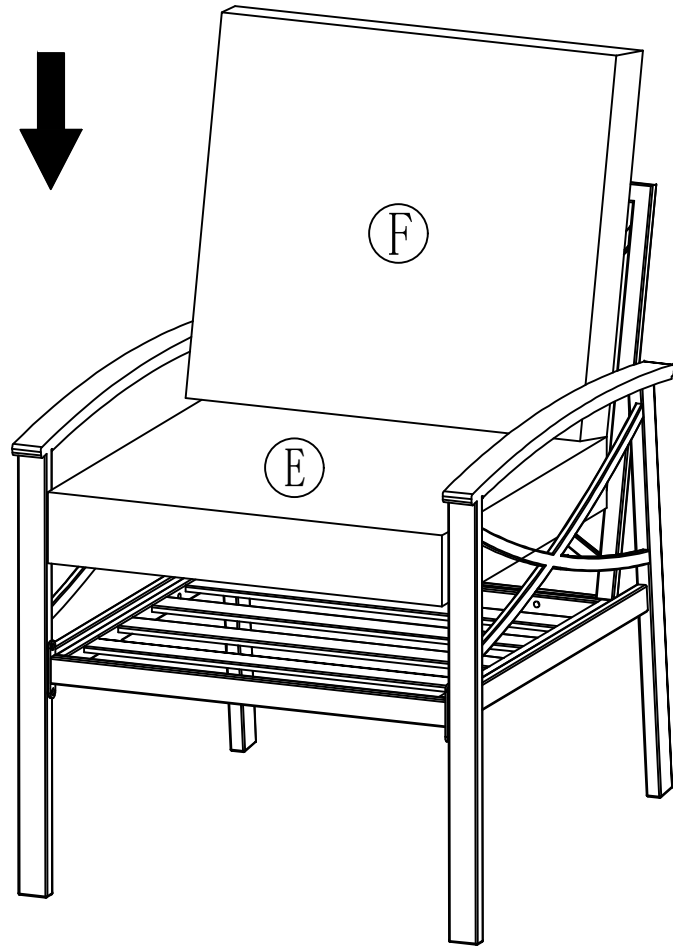

5

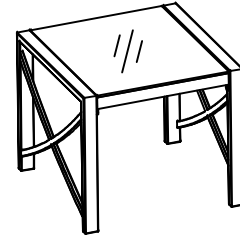

SIDE TABLE
X1

ⓖ X2

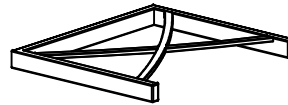

ⓓ X2



ⓔ X1

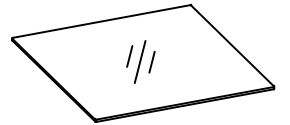

① X8







M6x15mm

④ X8



6

1

Ⓒ		X2
Ⓗ		X2
①		X8
④		X8

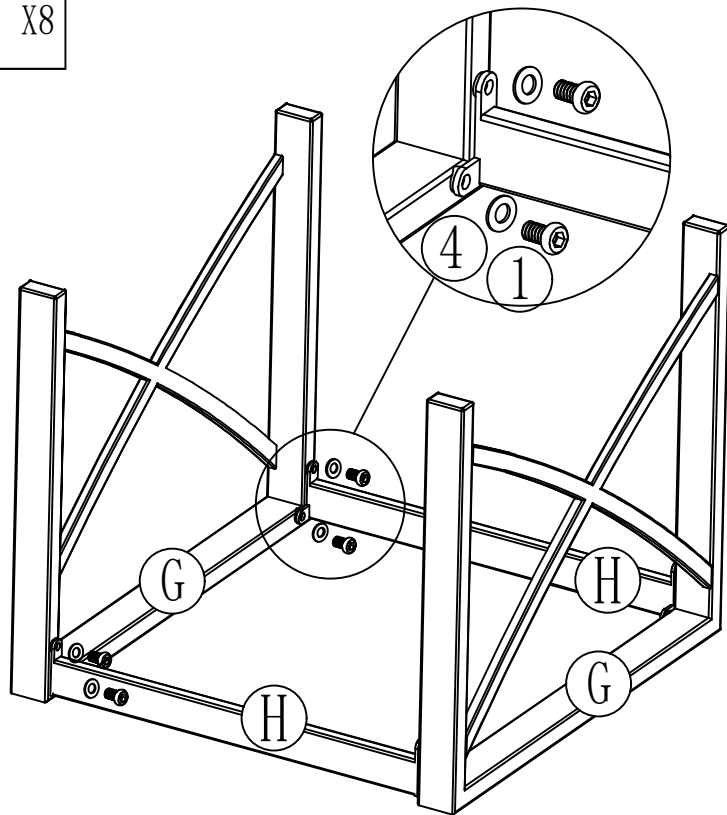

Note: During the assembly, please first half-tighten all the screws into the holes. After all the screws are set, fully tighten them.

EN

7

2

Ⓘ		X1
---	---	----

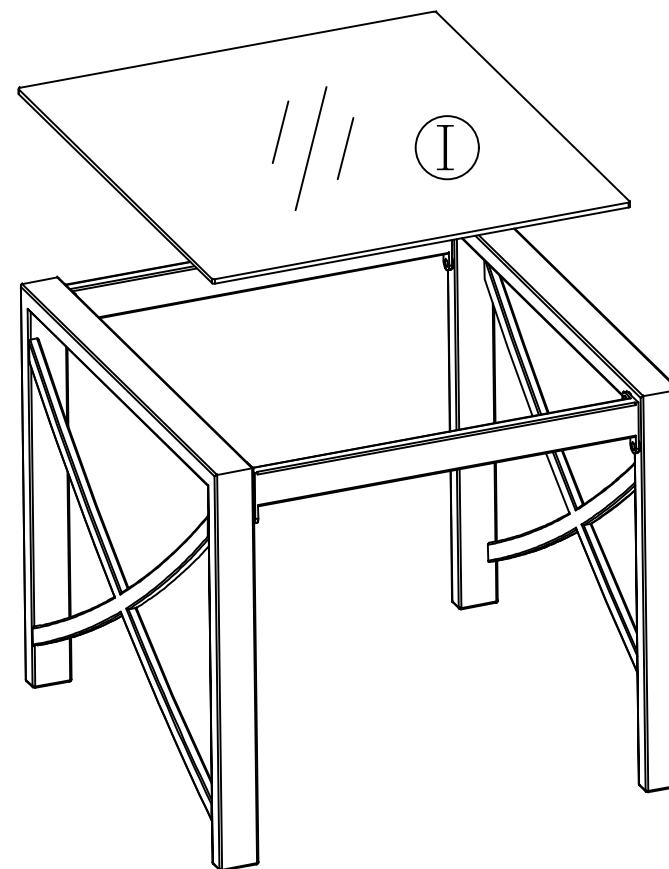

8