

Features

- Six transducers and a control amplifier with 25' (7.6 m) of wiring.
- User-friendly high-resolution color touch screen (in polished chrome).
- Blower motor with 300 W heater.
- Slotted overflow for maximum bathing depth.
- Molded lumbar support for comfort.
- Center drain.
- 72" (1829 mm) x 36" (914 mm) x 23" (584 mm)

Material

- Acrylic

Hydrotherapy

- 122 BubbleMassage™ airjets.
- With Zones of Control™ feature.

Installation

- Drop-in or under-mount installation.

Required Accessories

K-7271 Slotted Overflow Bath Drain

or

K-7272 Slotted Overflow Bath Drain



Codes/Standards

ASME A112.19.7/CSA B45.10

CSA B45.5/IAPMO Z124

ASTM E162

ASTM E662

UL 1795











CSA C22.2 No. 218.2

KOHLER® One-Year Limited Warranty

See website for detailed warranty information.

Available Color/Finishes

Color tiles intended for reference only.

Color	Code	Description
	0	White
	96	Biscuit
	47	Almond
	NY	Dune
	95	Ice™ Grey
	G9	Sandbar
	33	Mexican Sand™
	K4	Cashmere
	58	Thunder™ Grey
	7	Black Black™

No change in measurements if connected with required drain illustrated. (K-7272)

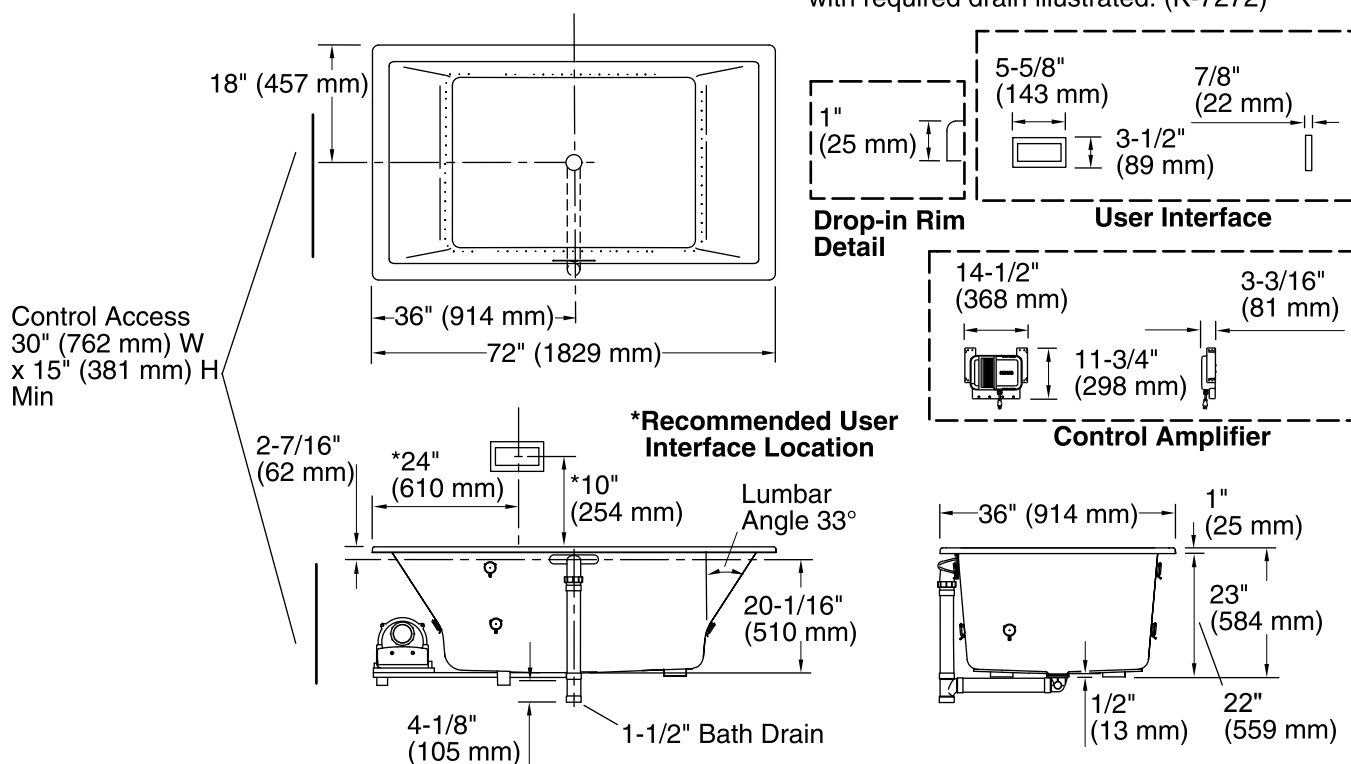

Required Electrical Service

One dedicated circuit required, protected with Class A Ground-Fault Circuit-Interrupter (GFCI) or Residual Current Device (RCD).

Blower, Amplifier, Heater: 120 V, 15 A, 60 Hz

Technical Information

All product dimensions are nominal.

Installation:	Drop-in/Undermount
Drain location:	Reversible
Basin area, bottom:	45-3/4" x 25-5/16" (1162 mm x 643 mm)
Basin area, top:	65-3/8" x 29-5/16" (1661 mm x 745 mm)
Weight:	117 lbs (53.1 kg)
Minimum floor load:	58.6 lbs/ft ² (286.1 kg/m ²)
Water depth:	19-7/16" (494 mm)
Water capacity:	112.9 gal (427.4 L)
Under-mount kit:	K-593
Electrical rating:	Blower: 120 V, 10 A, 60 Hz, 300 W Amplifier: 120 V, 50/60 Hz, 15 W Heater: 120 V, 0.5 A, 60 Hz, 65 W

Notes

Measure your actual product for roughing-in details.

Install this product according to the installation guide. Ensure that the bath, user interface, amplifier, and transducers are functional before completing the installation.

Control amplifier fits 16" (406 mm) center studs. 25' (7.6 m) cables are included.

Locate the bath within 24" (610 mm) of a GFCI-protected 120 V, 15 A grounded electrical outlet. A second grounded outlet within the wall framing must be within 24" (610 mm) of the planned control amplifier. One electrical service may be used for the entire bath and related electrical components.

Hot water supply should be 70% of capacity or greater. Installations will vary.