

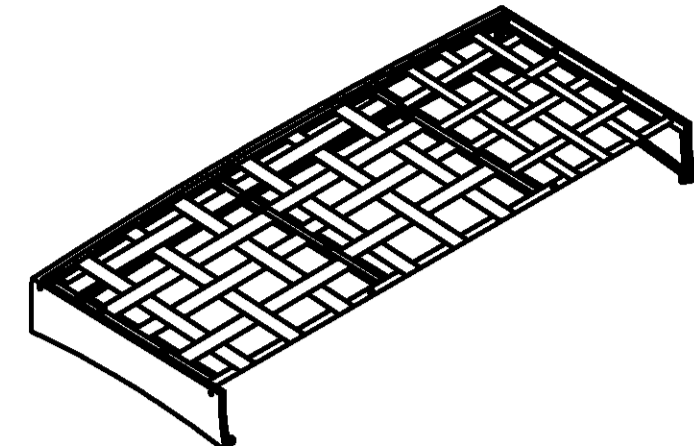

A		SEAT FRAME	1PCS
B		BACK FRAME	1PCS
C		LEG	2PCS
D		BOLT M6*45	2PCS
E		BOLT M6*25	8PCS
F		WASHER	10PCS
G		PLASTIC BOLT CAP	10PCS

  
**QTY1**  
**ALLEN WRENCH**

## STEP 1

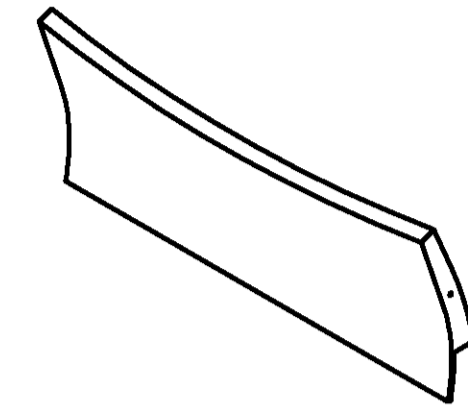
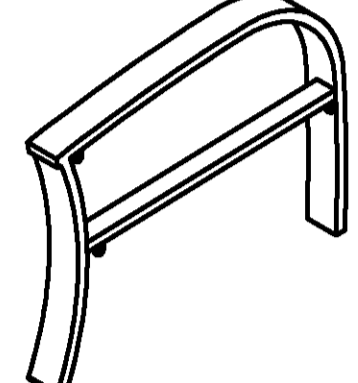

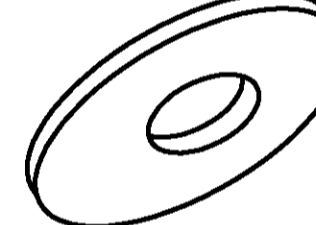
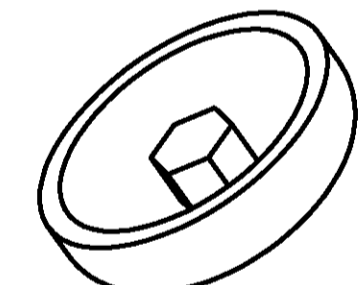
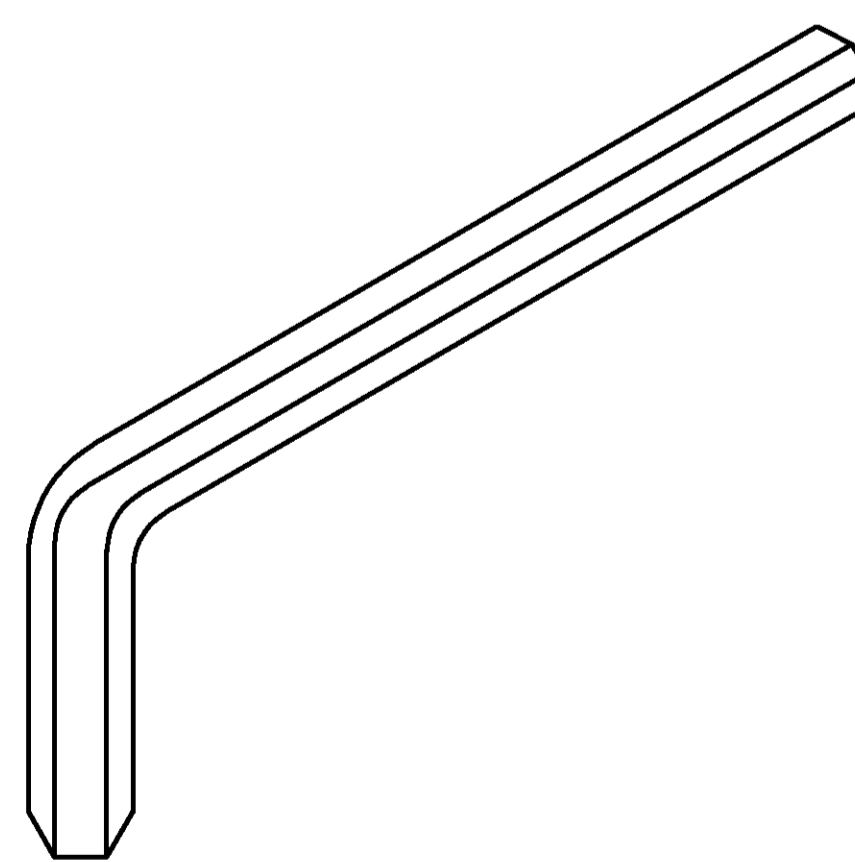
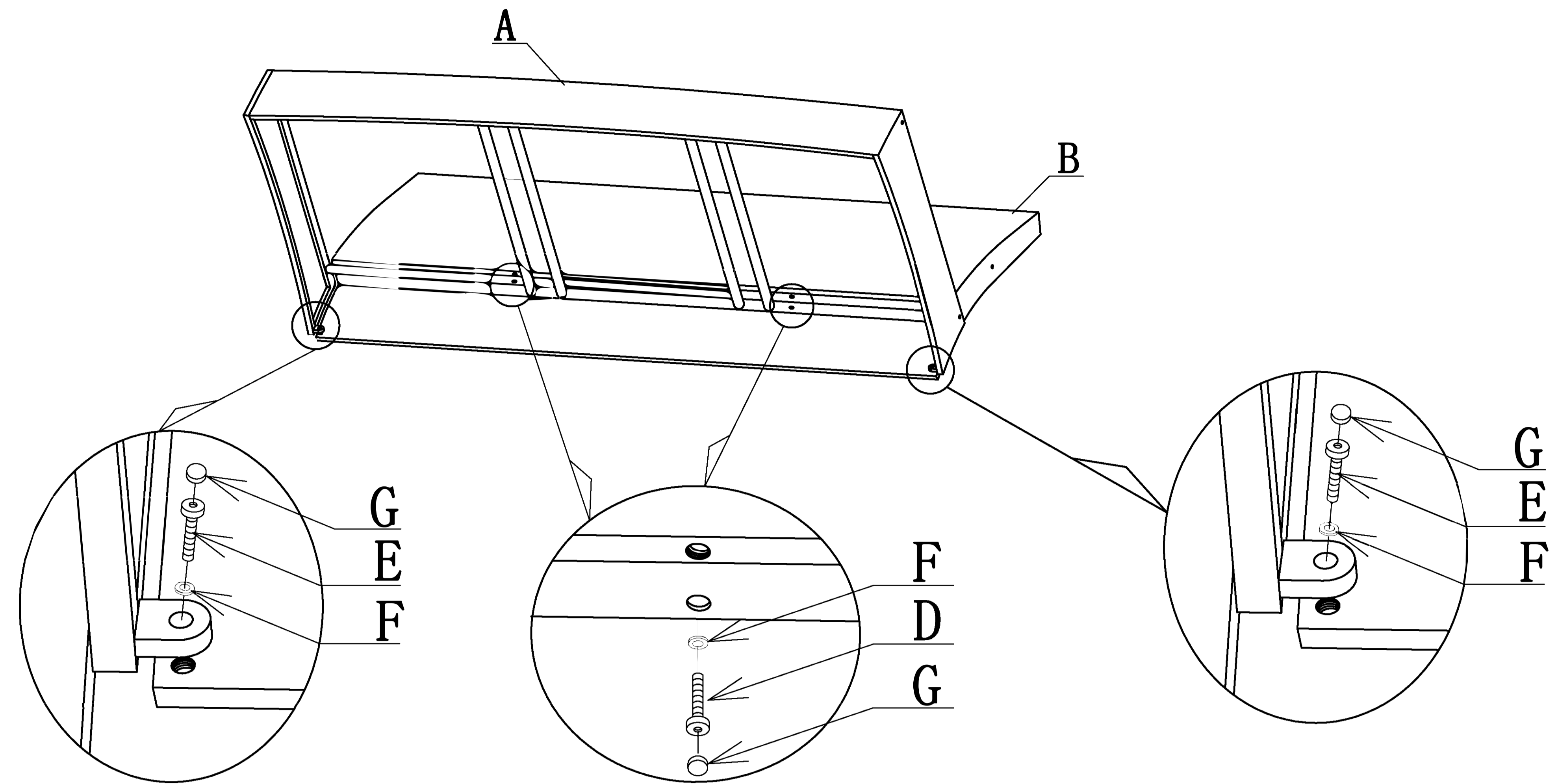
## STEP 2

