



# ASSEMBLY INSTRUCTIONS

## ASSEMBLY PARTS

- 1.Slat Frames----- 2pcs
- 2.Bolts----- 4pcs
- 3.Nuts----- 8pcs

			
①. x 2pcs	( $\varnothing 8 \times 80$ ) ②. x 4pcs	( $\varnothing 8$ ) ③. x 8pcs	④. x 2pcs

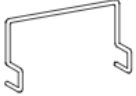
Place bed slats in reverse position, tighten both slats using washers and "butterfly" bolts.

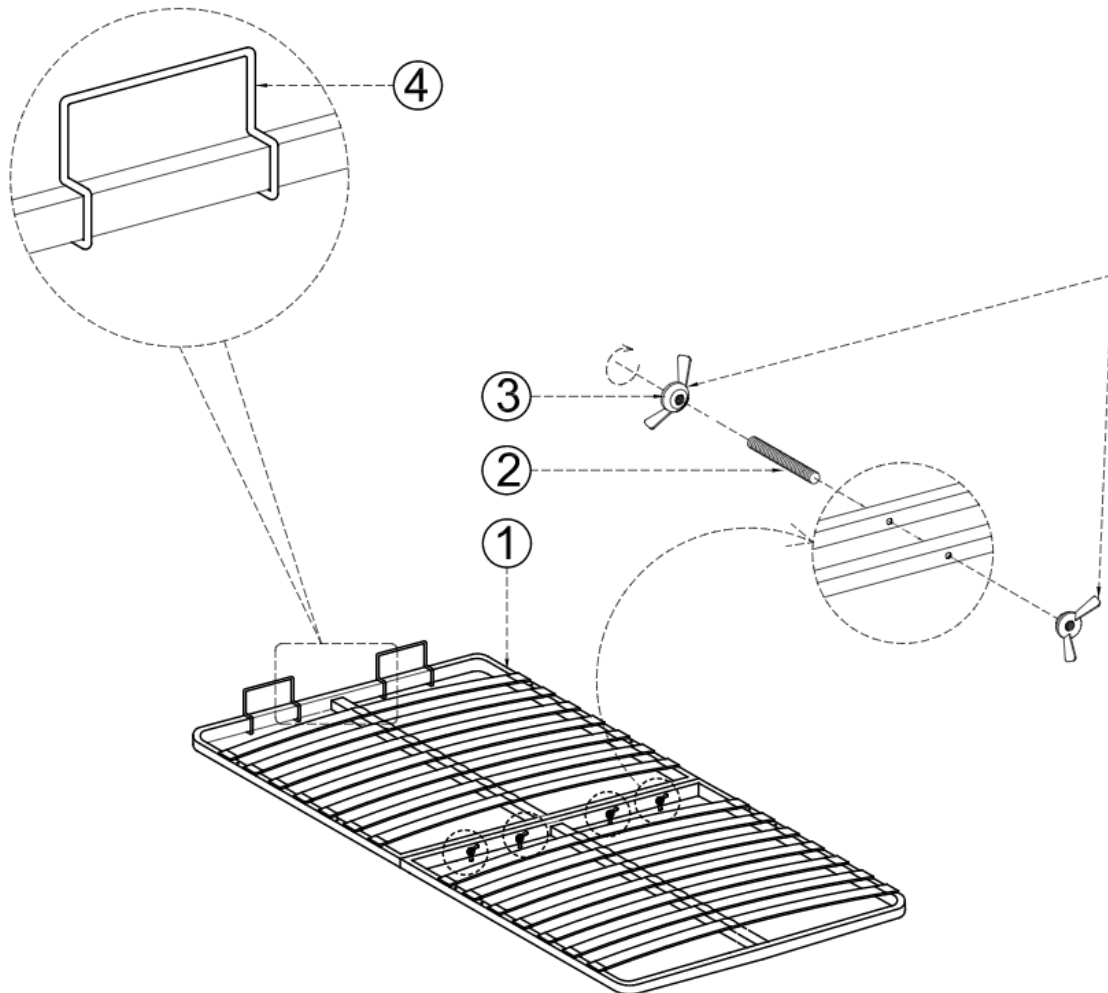

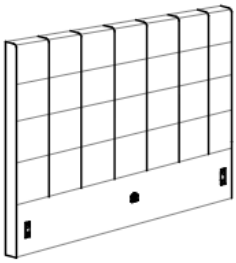
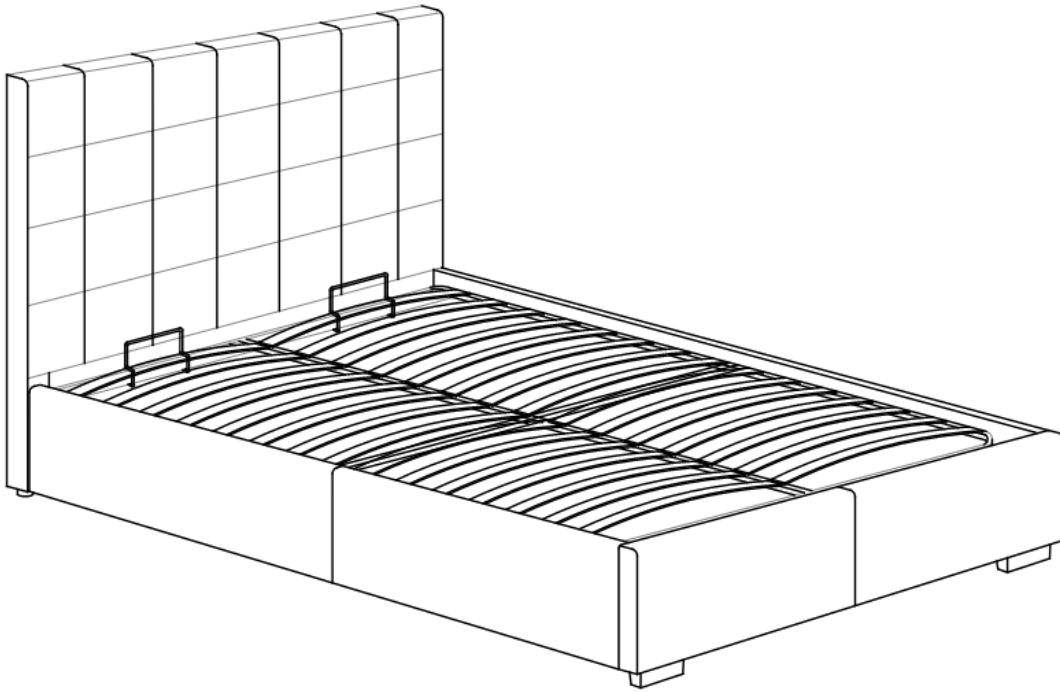

① Headboard=1pc



② Side Rails=2pcs

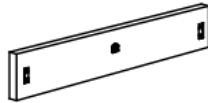

③ Footboard=1pc



④ Feet=4pcs

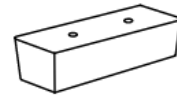

⑤ Feet=2pcs



⑥ Screws(m8\*50)  
=4pcs



⑦ Centre Supporter Rails  
=2pcs



⑧ Slat Frame  
=1pc



⑨ Bolts (M4\*10)  
=6pcs

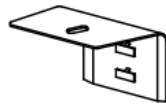

⑩ Brackets=6pcs



⑪ Stick Felts=6pcs



⑫ Handle=1pc

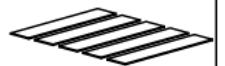

⑬ Baseboards  
= 5 pcs





2



9

## Assembly instructions:

1. Assemble the feet to the headboard and footboard using bolts ( $\varnothing 8 \times 40$ ).
2. Hook the side rails into the slots located at the headboard and footboard.
3. Place 2pcs of the base boards onto the bed frame.
4. Assemble the bed slats using washers and bolts( $\varnothing 8 \times 45$ ) to the side rails.
5. Strape the handle onto the bed slats.
6. Tighten the piston.