

Assembly Instruction

SHIP IN
3
BOXES

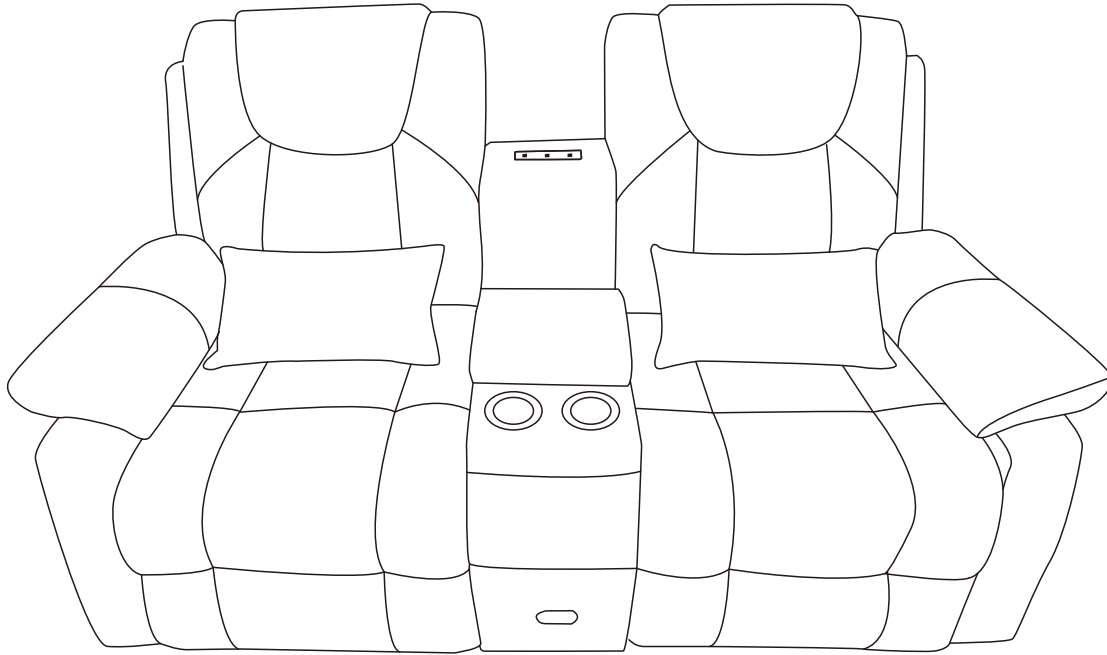







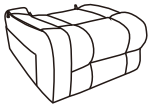

Thanks for purchasing our products.



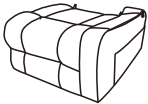







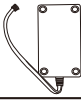
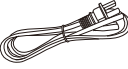

To ensure this product's safe and satisfactory use, please read the following instructions carefully before assembly.

1. This sofa ships in 3 boxes, we recommend to assemble after the 3 boxes are all received.
2. If any part is missing or damaged, please send messages with the detailed part name to us, and we will ship the replacement part to you ASAP.

Assembly Instruction

BOX-A			
NO.	DRAWING	QTY	DESCRIPTION
A		1	LEFT SEAT
G1		1	ARM CUSHION
H1		1	LEFT EAR
I1		1	PILLOWS
BOX-B			
B		1	RIGHT SEAT
G2		1	ARM CUSHION
H2		1	RIGHT EAR
I2		1	PILLOWS

BOX-C

C		1	CONSOLE
D		1	CONSOLE BACK REST
E		1	LSF BACK REST
F		1	RSF BACK REST
J		1	POWER SOURCE
K		1	CONNECTION WIRE
L		4	CONNECTOR
M		8	NUT
N		8	PLASTIC PAD
O	 M6X20	16	SCREW
P		1	ALLEN KEY
Q		1	Y-CABLE
R		2	SCREW
S		2	PLUM BLOSSOM SCREW

STEP 1

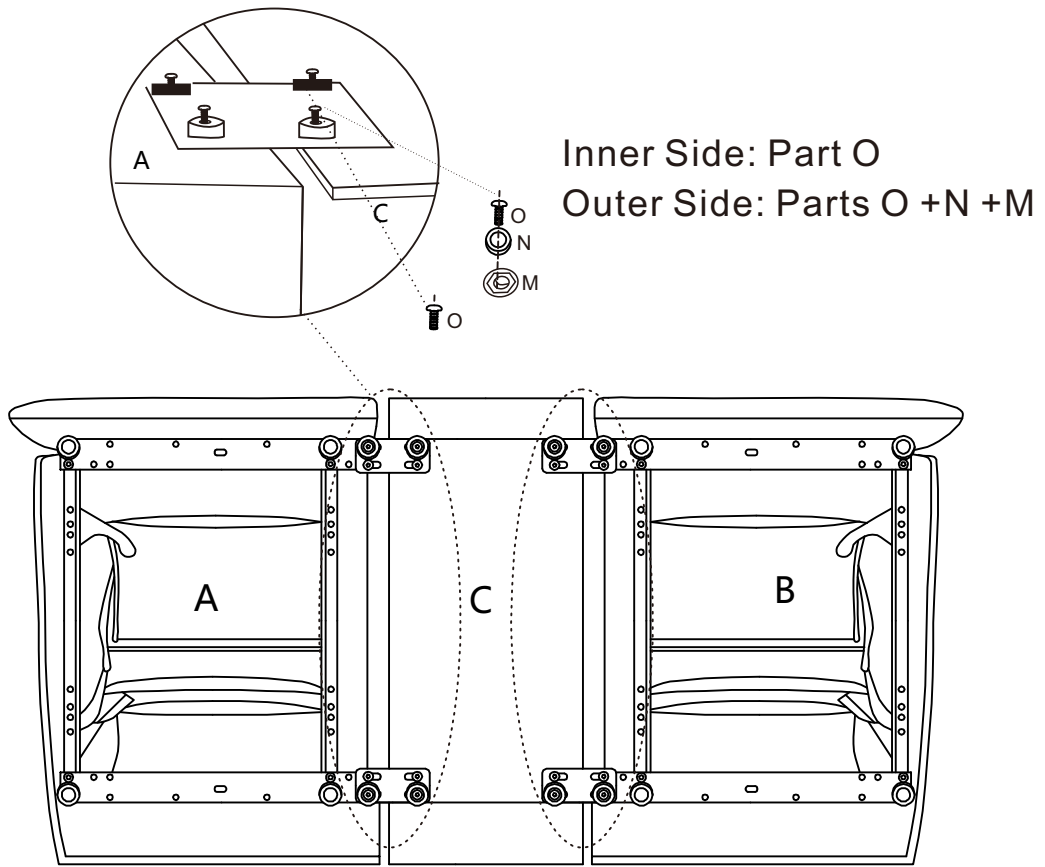

STEP 2

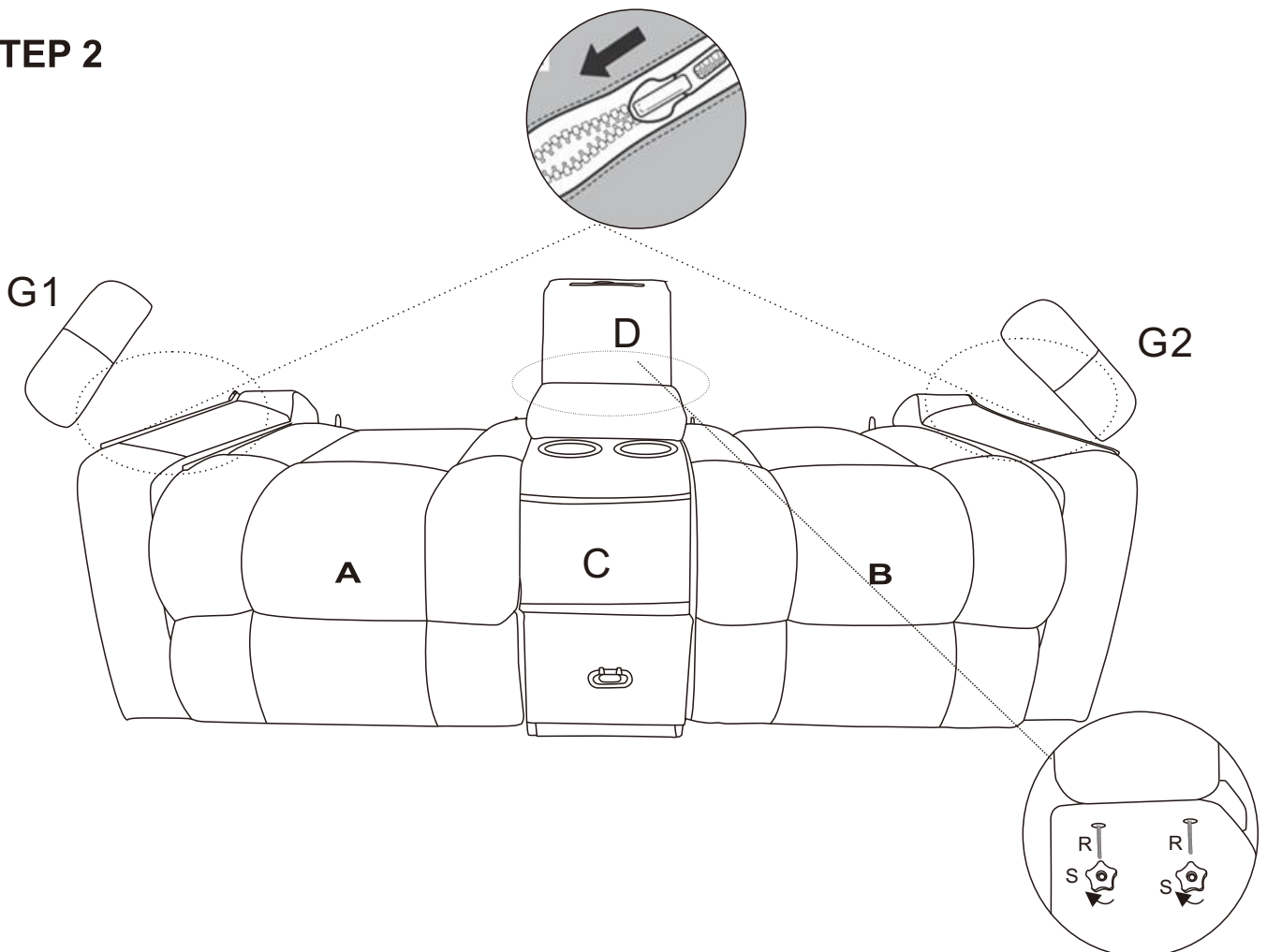

STEP 3

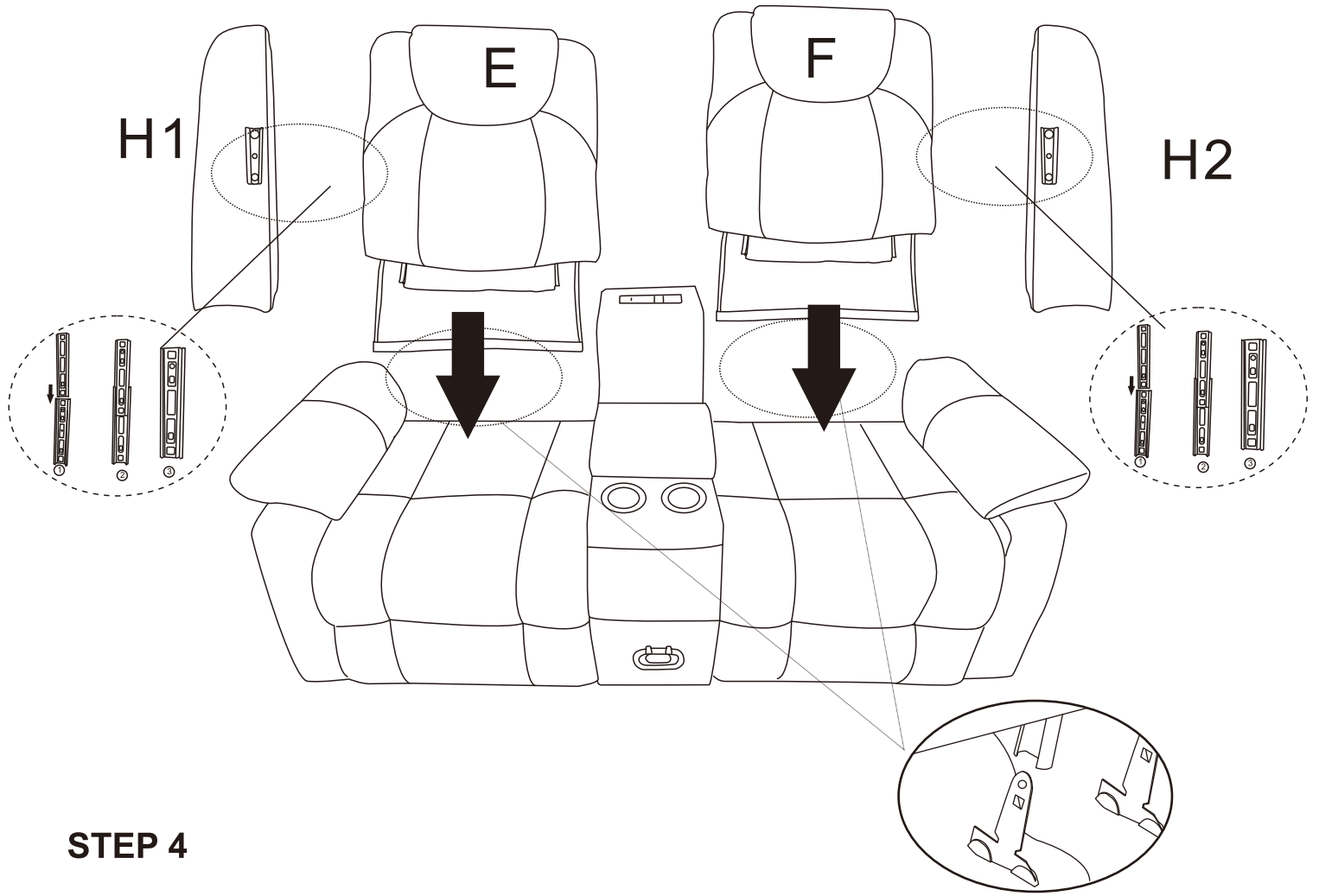

STEP 4

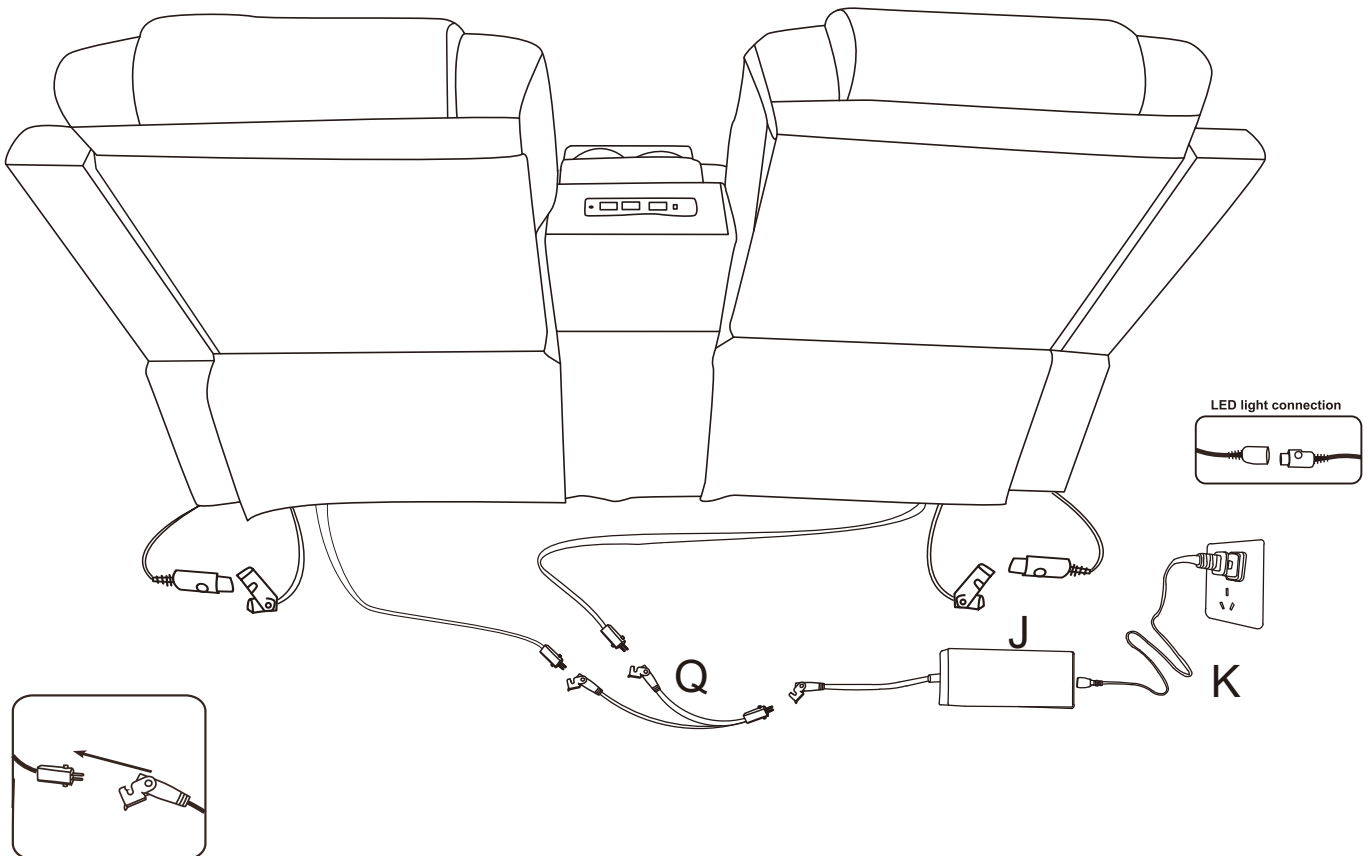

STEP 5

How to recline

 **Warning: Do not sit or hit the footrest after lift up.**

Notice:

1. The USB charging port is intended solely for charging low-power electronic devices such as smartphones and iPads.
2. It is normal for the control panel surface to become slightly warm during the charging process.
3. The charging method is slow charging. In the event of high load, the USB charging port will activate the power-off protection function. Once the load returns to n the charging function will automatically resume.

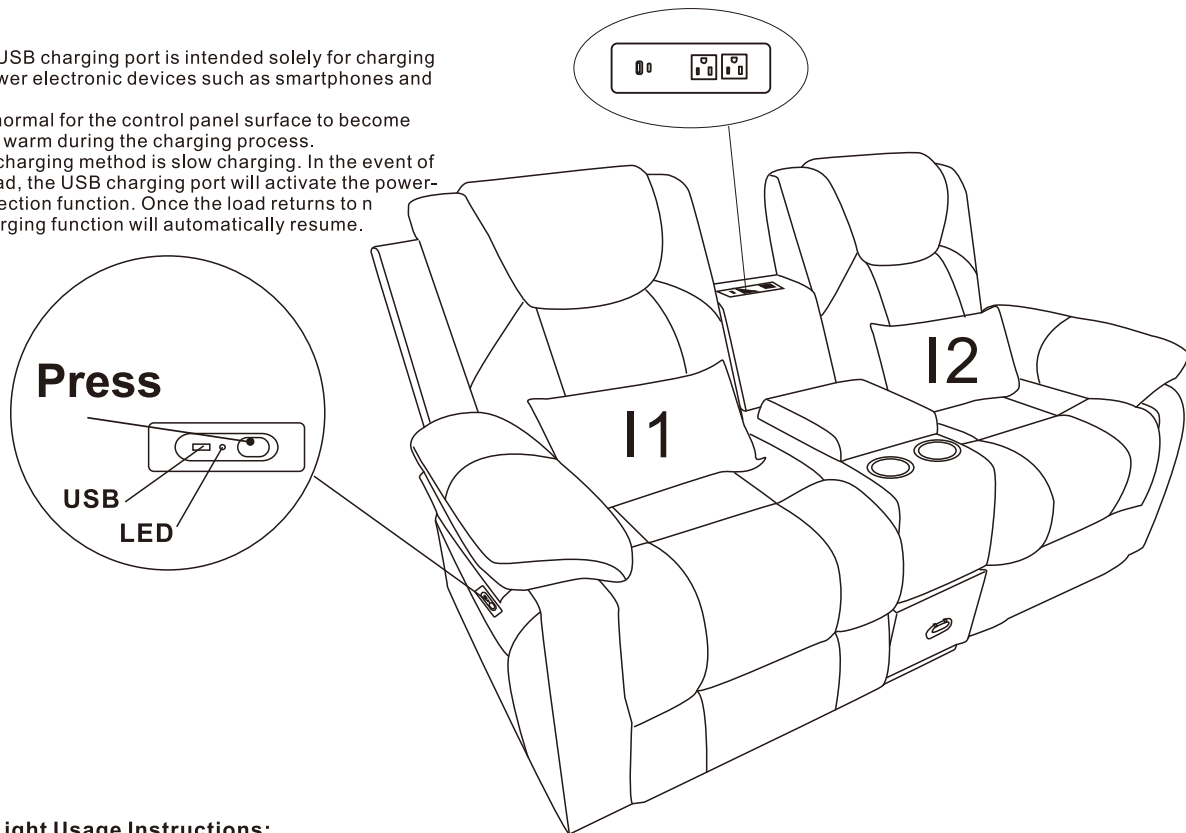

LED Light Usage Instructions:

1. Power On Standby Mode LED Light switch off
 2. Press the button for the 1st time LED Light in full blue mode
 3. Press the button for the 2nd time LED Light in full red mode
 4. Press the button for the 3rd time LED Light in full green mode
 5. Press the button for the 4th time LED Light enters the multiple color-changing modes
 6. Press and hold the button for 2 seconds and LED light will turn off.
- If the button is not pressed, the LED light will automatically turn off after 30 minutes and enter standby mode.

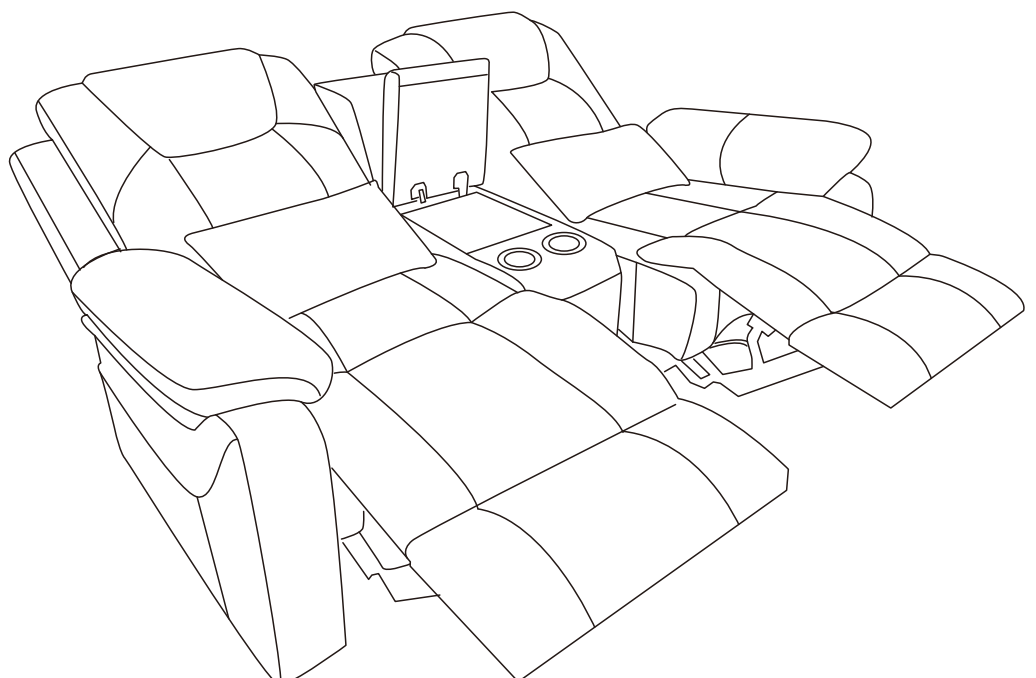
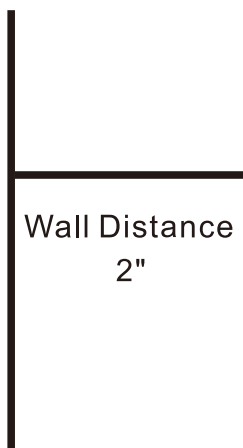

THE CONSOLE

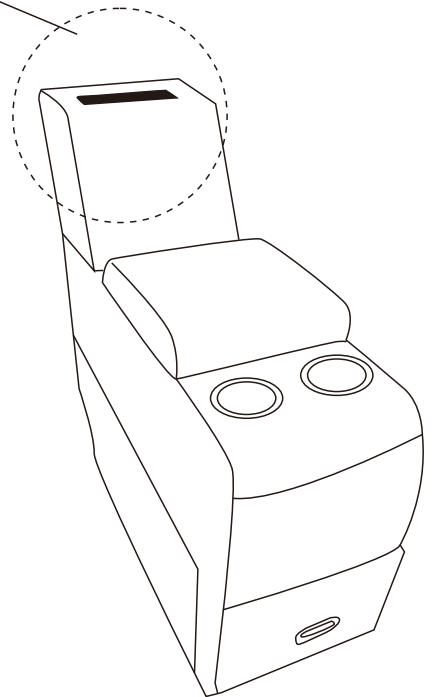
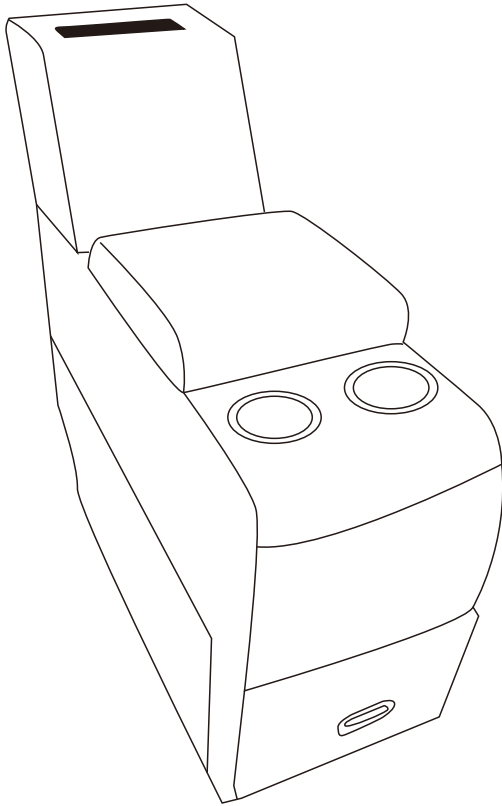

Electrical Specification:

1. Input voltage: 110VAC~230VAC.
2. Input current: 10A~16A
3. Frequency 50Hz~60Hz
4. USB: 5V3A、 9V2A、 12V1.5A
5. Type-C: 5V3A、 9V2.22A、 12V1.67A.
6. Power cable specification: 14#*16#*18#

Announcement:

1. Do not allow water seepage and beating, should not be installed outdoors and on the ground.
2. each product is affixed with the "etl"/ul certification label and warning to prevent occurrence dangerous, please use correct location of the indoor residence.

Notes:

- This product features electrical components. Do not expose this product to high temperature or humidity.
- Always unplug this appliance when not in use.
- Only plug this product into a grounded outlet.
- Do not plug this product in with an electrical adaptor.
- Do not modify the plug.
- Do not leave with unattended children and individuals with impairments that may prevent them from safely operating this product.

Warning

Do not sit/kick/stand on the footrest after lift up

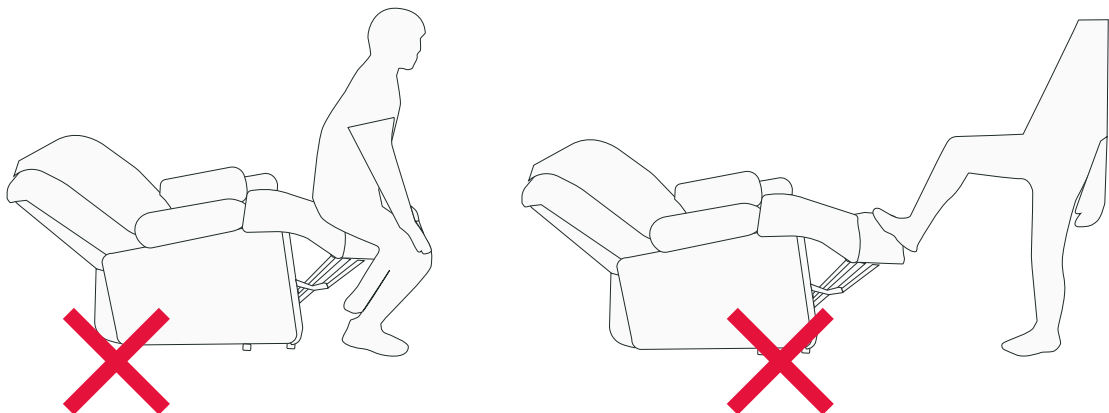
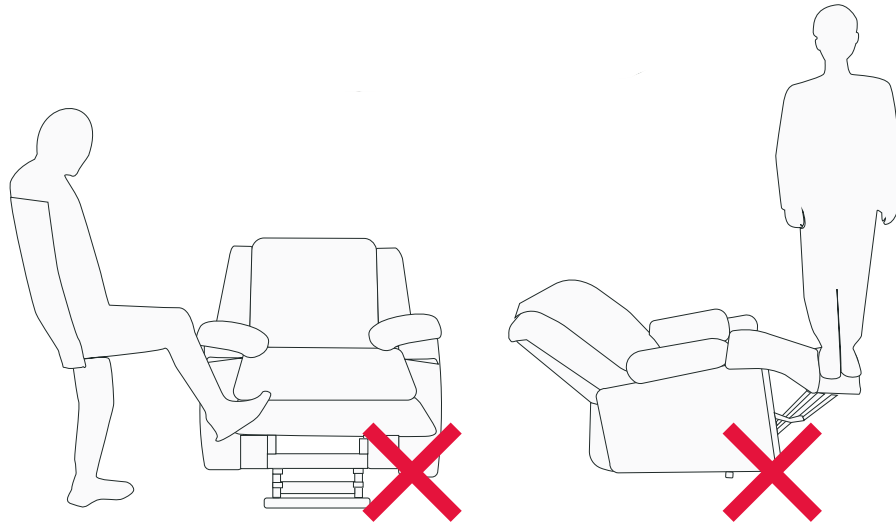

Leave 2" space between chair back and wall before reclining

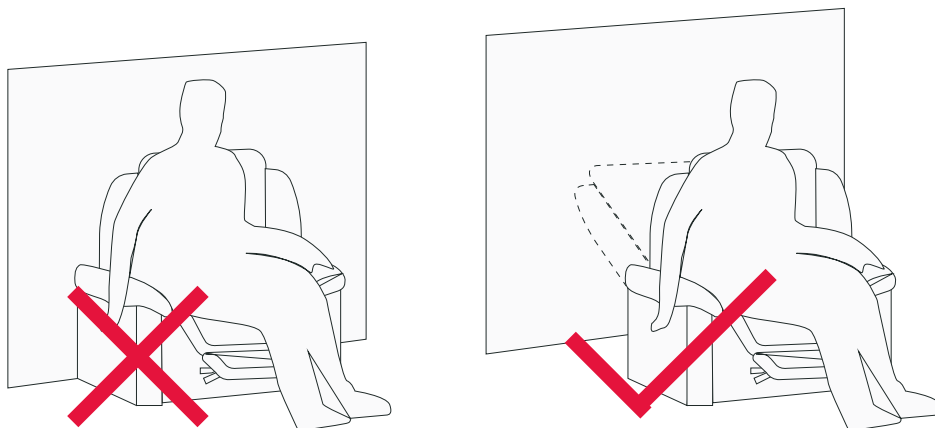

Warning

2-Person lift

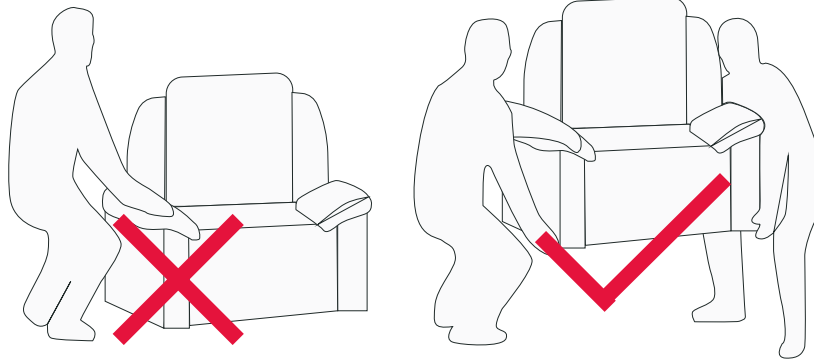

Do not move chair when it's reclining

