

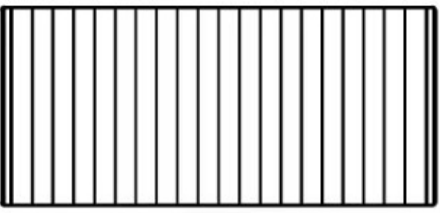

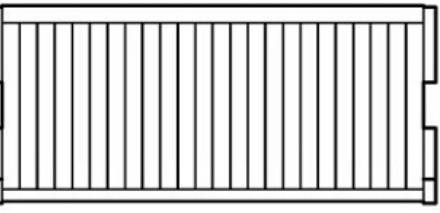

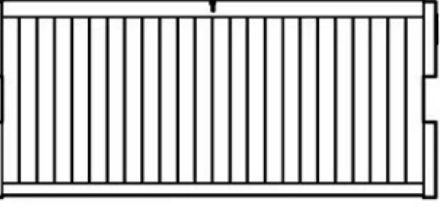
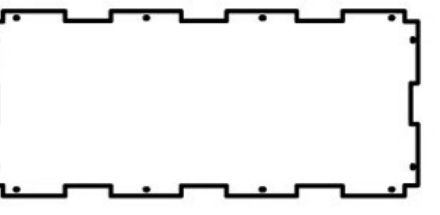
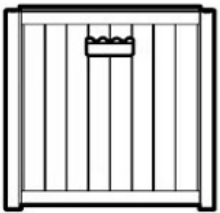

Installation Instruction

(All assembly needs to be done on a level ground)

PARTS LIST:

- A  Lid
- B  Back Panel
- C  Front panel (With the lock hole)
- D  Bottom Panel
- E  Right & Left Side Panel

-  HGSL (Right & Left) × 2pcs
-  Lock A
-  Lock B
-  Hook × 4pcs
-  Screws × 16pcs

(! Important note: All assembly needs to be done on a level ground)

STEP 1: Fix the B and C onto the D

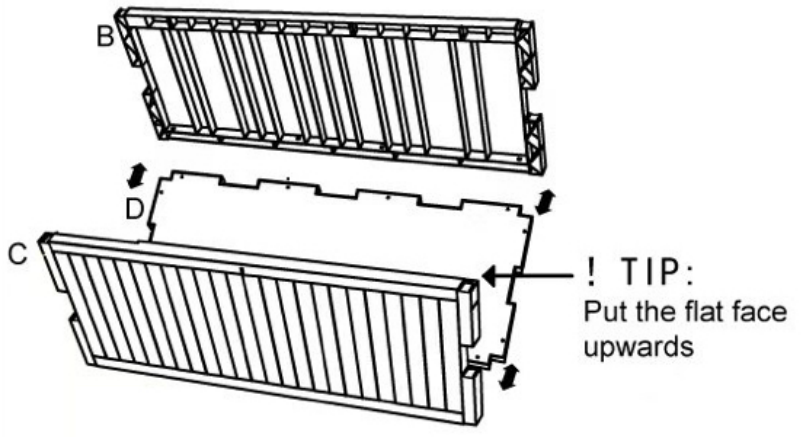

STEP 2: Fix the E onto the D and C

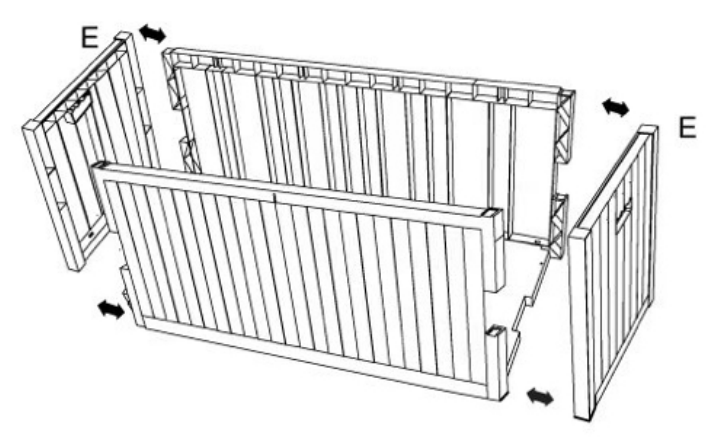

STEP 4: Connect A and B with four hooks

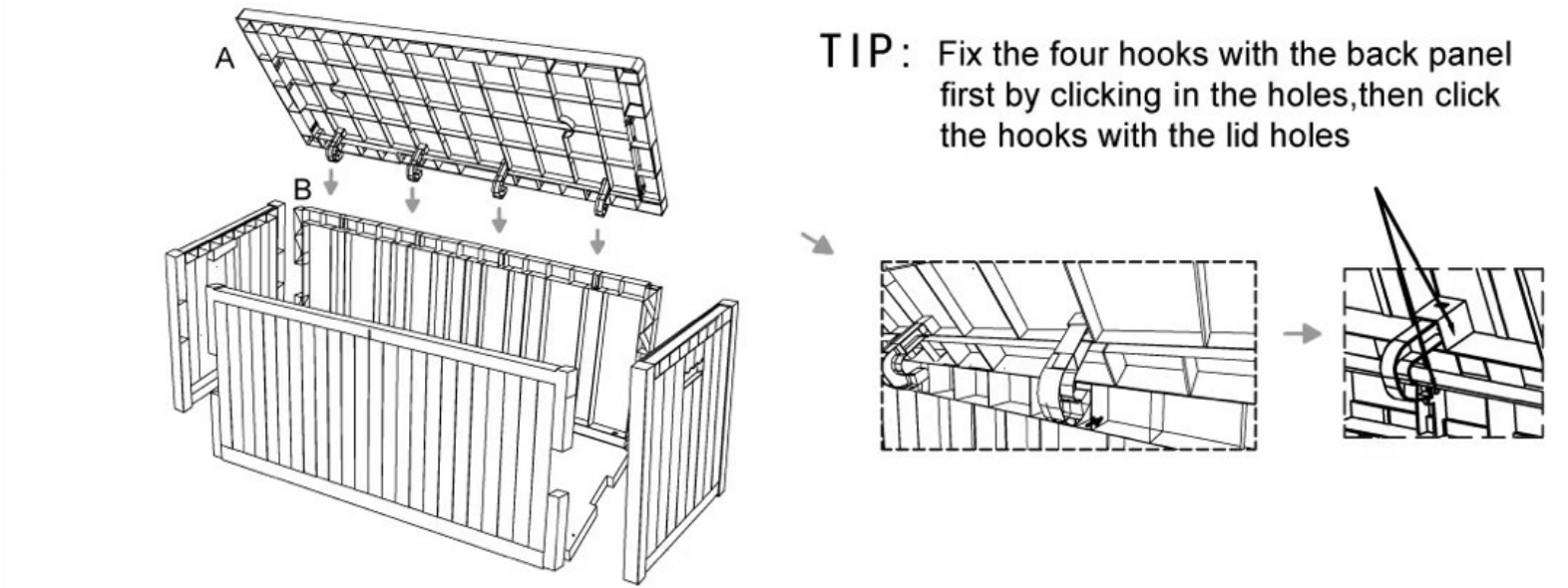

STEP 3: Install the four hooks on A

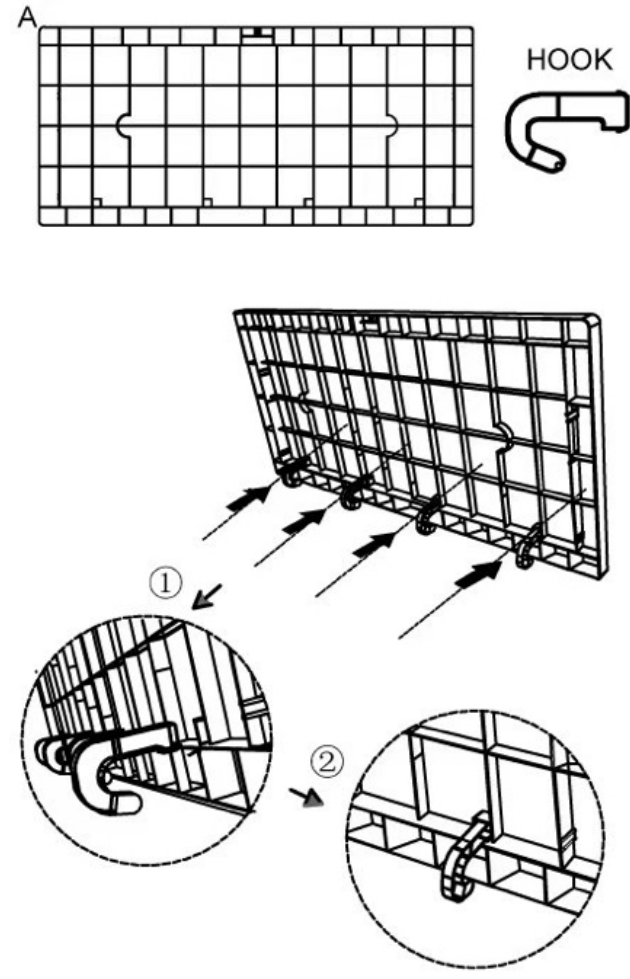

STEP 6: Done

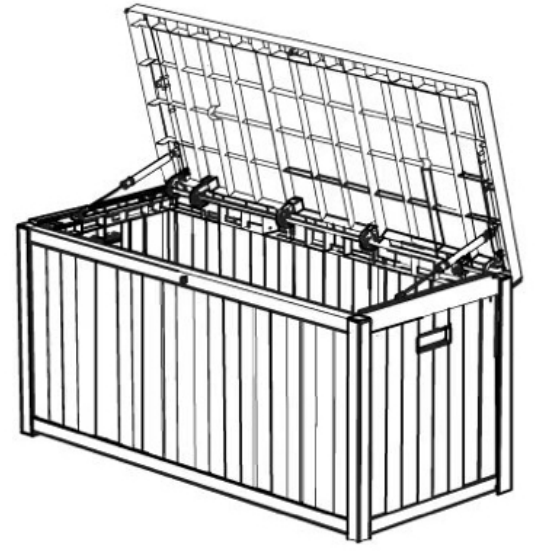

STEP 5: Fix the HGSL(Right) and HGSL(Left) with screws to A and E

