

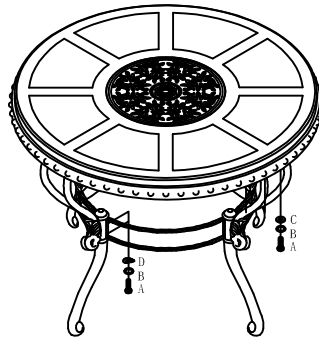

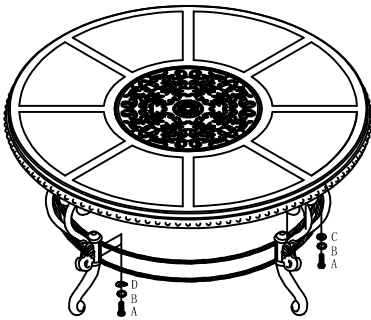





## ASSEMBLY INSTRUCTION

Thank you for purchasing this quality product. Be sure to check all packing material carefully for small parts which may have come loose inside the carton during shipment. Identify and count all parts and compare with the Parts List below.



NO:	DRAWING	Q' TY	DESCRIPTION
A		20	1/4" ALLEN BOLT
B		20	1/4" SPRING WASHER
C		12	1/4" METAL WASHER
D		8	1/4" CAMBER WASHER
E		1	4mm HEX. WRENCH

MADE IN CHINA

NO:	DRAWING	Q' TY	DESCRIPTION
A		18	1/4" ALLEN BOLT
B		18	1/4" SPRING WASHER
C		10	1/4" METAL WASHER
D		8	1/4" CAMBER WASHER
E		1	4mm HEX. WRENCH

MADE IN CHINA