

Tools Recommended

EN_IMPORTANT, RETAIN FOR FUTURE REFERENCE: READ CAREFULLY.

FR_IMPORTANT: A LIRE ATTENTIVEMENT ET À CONSERVER POUR CONSULTATION ULTÉRIEURE.

ES_IMPORTANTE, LEA Y GUARDE PARA FUTURAS REFERENCIAS.

PT_IMPORTANTE, RETER PARA REFERÊNCIA FUTURA: LEIA ATENTAMENTE.

DE_WICHTIG! SORGFÄLTIG LESEN UND FÜR SPÄTER NACHSCHLAGEN AUFBEWAHREN.

IT_IMPORTANTE! CONSERVARE IL PRESENTE MANUALE PER FUTURO RIFERIMENTO E LEGGERLO ATTENTAMENTE.

EN

Dear customer,

Thank you for purchasing this product. So that your appliance serves you well, please read all the instructions in this user's manual. If you have any questions, please contact our customer care center, Our contact details are below:

FR

Cher client,

Nous vous remercions d'avoir acheté ce produit. Afin que vous puissiez profiter pleinement de votre appareil, veuillez lire toutes les instructions de ce manuel d'utilisation. Si vous avez la moindre question, veuillez contacter notre centre d'assistance à la clientèle, Nos coordonnées sont les suivantes:

DE

Sehr geehrter Kunde,

Vielen Dank, dass Sie dieses Produkt erworben haben. Damit Ihr Gerät Ihnen gute Dienste leistet, lesen Sie bitte alle Hinweise in diesem Benutzerhandbuch. Wenn Sie Fragen haben, wenden Sie sich bitte an unser Kundendienstzentrum, Unsere Kontaktdaten stehen unten:

ES

Queridos clientes,

Gracias por comprar este producto. Para que su electrodoméstico le sirva mejor, lea todas las instrucciones de este manual del usuario. Si tiene alguna pregunta, comuníquese con nuestro Centro de Atención al Cliente, Nuestros datos de contacto son los siguientes:

PT



Caros clientes,

Obrigado por adquirir este produto. Para que o seu aparelho o sirva melhor, leia todas as instruções deste manual do utilizador. Se tiver alguma dúvida, por favor contacte o nosso Centro de Atendimento ao Cliente, Os nossos dados de contacto são os seguintes:



IT

Caro Cliente,

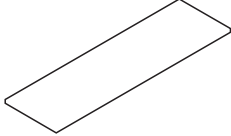
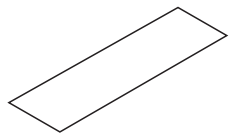
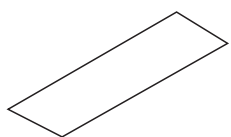
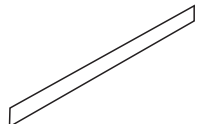
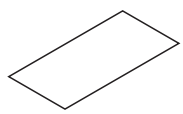
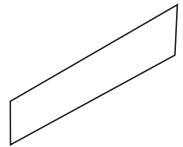
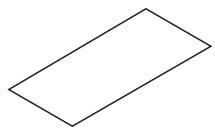

Grazie per aver acquistato questo prodotto. Per servirti meglio con questo apparecchio ti prego di leggere tutte le istruzioni in presente manuale utente. In caso di dubbio, si prega di contattare il nostro centro assistenza clienti, I nostri dettagli di contatto sono di seguito:

Country	 Phone	 Email
US		
CA		
UK		
DE		
FR		
ES		
PT		
IT		

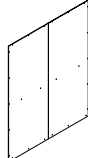

BOX-1/2

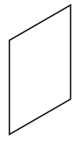
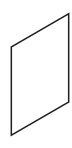
NO.	PARTS	QTY
1		1
2		1
3		1
4		1
5		1
6		1
9		1
10		1
11		1
14		1

BOX-1/2

NO.	PARTS	QTY
15		2
16		1
17		1
A ~ Q		1

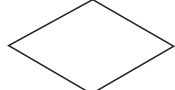
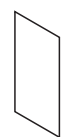
BOX-2/2

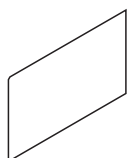
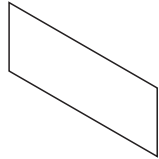
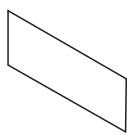
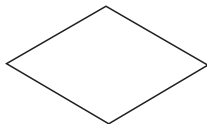
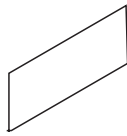
NO.	PARTS	QTY
7		1
8		1
12		1
13		1
18		1
19		3
20		3
21		3
22		3
23		3

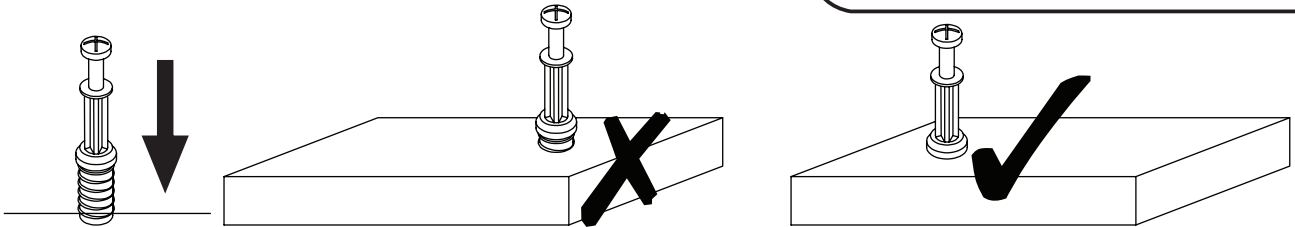

EN_QUICKFIT: Tighten quickfit until shoulder is flush with panel. Do not overtighten or undertighten.

FR_RACCORD RAPIDE: Faites serrer le raccord rapide jusqu'à ce que l'épaulement soit parfaitement encastré dans le panneau. Il ne faut ni trop serrer ni insuffisamment serrer.

ES_QUICKFIT: Apriete quickfit hasta que el hombro se descargue con el panel. NO lo sobreapriete ni lo apriete poco.

PT_AJUSTE RÁPIDO: Aperte o ajuste rápido até estar nivelada com o painel. Não apertar demasiado ou excessivamente.

DE_QUICKFIT: Ziehen Sie den Quickfit fest, bis die Schulter mit der Platte bündig ist. Bitte nicht zu fest oder zu schwach anziehen.

IT_MONTAGGIO RAPIDO: Stringere il montaggio rapido fino a quando la spalla è a filo con il pannello, non stringere troppo o troppo poco.

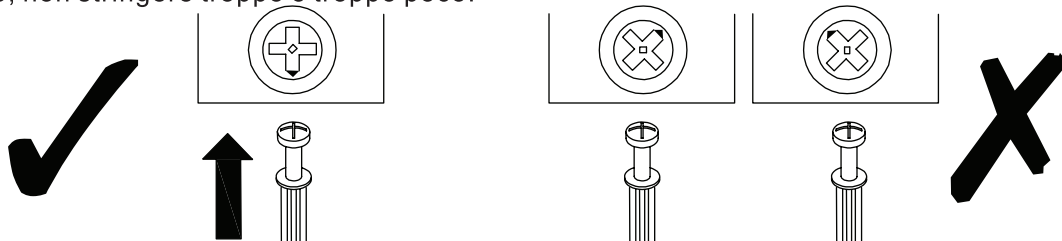

EN_CAM LOCK: When fitting cam lock, ensure starting position is correct before you insert connecting quickfit.

FR_SERRURE BATTEUSE: Avant d'insérer la serrure batteuse, veillez à la bonne orientation avant d'insérer le raccord rapide.

ES_CIERRE DE LA CÁMARA: Cuando instale el cierre de la cámara, asegúrese de que la posición de inicio es correcta antes de que inserte el quickfit conector.

PT_BLOQUEIO: Ao instalar o bloqueio, assegurar-se de que a posição inicial está correcta antes de inserir o encaixe de ligação rápida.

DE_CAM-LOCK: Achten Sie bei der Montage des Cam-Locks auf die richtige Ausgangsposition, bevor Sie den Quickfit einsetzen.

IT_BLOCCAGGIO A CAMMA: Quando si monta il bloccaggio a camma, assicurarsi che la posizione iniziale sia corretta prima di inserire il montaggio rapido di collegamento.

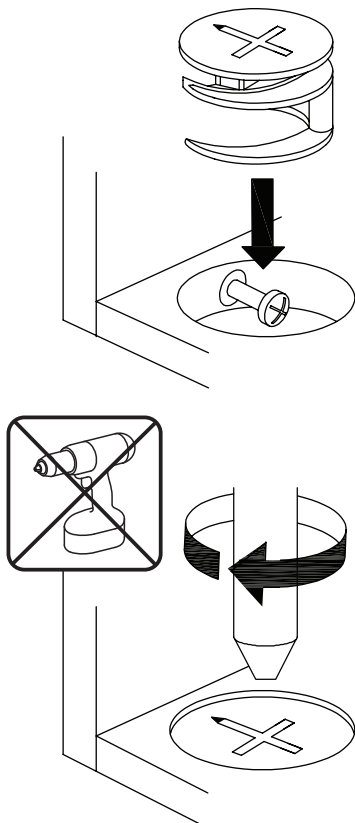

EN_Quickfit head should be in the centre of the cam lock when the two panels are joined.

Cam lock should be inserted before quickfit.

FR_Lorsque les deux panneaux sont assemblés, la tête du raccord rapide doit reposer au centre de la serrure batteuse.

Il faut insérer la serrure batteuse avant le raccord rapide.

ES_El cabezal del quickfit debe estar en el centro del cierre de la cámara cuando se unan los dos paneles.

Se debe insertar el cierre de la cámara antes que el quickfit.

PT_A cabeça de ajuste rápido deve estar no centro da fechadura quando os dois painéis estão unidos.

A fechadura de cames deve ser inserida antes de ser rápida.

DE_Der Quickfit-Kopf sollte sich in der Mitte des Cam-Locks befinden, wenn die beiden Platten zusammengefügt sind.

Der Cam-Lock sollte vor dem Quickfit eingesetzt werden.

IT_La testa del montaggio rapido deve trovarsi al centro del bloccaggio a camma quando i due pannelli sono uniti.

Il Bloccaggio a Camma deve essere inserito prima del montaggio rapido.

EN_Turn cam lock clockwise to tighten.

FR_Faites tourner la serrure batteuse dans le sens des aiguilles d'une montre pour la resserrer.

ES_Gire el cierre de la cámara en sentido horario para apretarlo.

PT_Rodar o bloqueio no sentido dos ponteiros do relógio para o apertar.

DE_Drehen Sie den Cam-Lock im Uhrzeigersinn, um ihn festzuziehen.

IT_Ruotare il bloccaggio a camma in senso orario per stringere.

EN It may be necessary to adjust the hinges so that the doors align. Use the instructions below as a guide.

FR Il est parfois nécessaire d'ajuster les charnières pour un meilleur alignement des portes. Servez-vous des instructions ci-dessous comme guide.

ES Puede que sea necesario ajustar los quicios de forma que se alineen las puertas. Use las instrucciones que aparecen debajo como guía.

PT Pode ser necessário ajustar as dobradiças para que as portas fiquem alinhadas. Utilizar as instruções abaixo como guia.

DE Möglicherweise müssen Sie die Scharniere so einstellen, dass die Türen ausgerichtet sind. Verwenden Sie die nachstehenden Anweisungen als Leitfaden.

IT Potrebbe essere necessario regolare le cerniere in modo che le porte siano allineate. Per fare ciò attenersi alle istruzioni sottostanti.

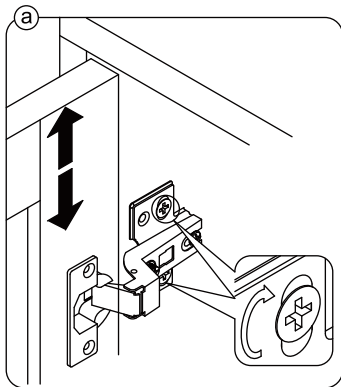

EN To adjust the door vertically loosen the screw as shown and move up and down as needed.

FR Si vous souhaitez régler la porte **verticalement**, desserrez la vis comme indiqué et déplacez la porte de haut en bas selon les besoins.

ES Para ajustar la puerta **verticalmente** afloje el tornillo tal y como se muestra y muévelo hacia arriba o hacia abajo según sea necesario.

PT Para ajustar a porta na vertical, soltar o parafuso mostrado e mover-se para cima e para baixo, conforme necessário.

DE Um die Tür **vertikal** auszurichten, lösen Sie die Schraube wie abgebildet und bewegen Sie sie nach Bedarf nach oben oder nach unten.

IT Per allineare la porta **verticalmente** allentare la vite come mostrato e spostarla in alto o in basso secondo necessità.

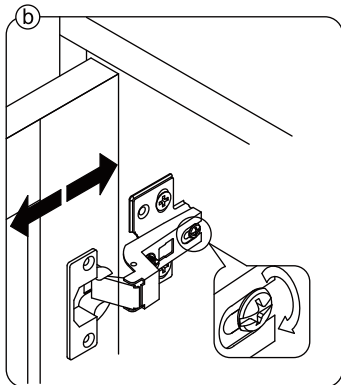

EN To adjust the gap from the door to the main frame turn the screw clockwise or anti-clockwise as needed.

FR Si vous souhaitez ajuster l'**écart** entre la porte et le cadre principal, tournez la vis dans le sens des aiguilles d'une montre ou dans le sens inverse, si nécessaire.

ES Para ajustar el **espacio** desde la puerta al marco principal, gire el tornillo en sentido horario o antihorario, según se necesite.

PT Para ajustar o espaço entre a porta e o quadro principal, rode o parafuso no sentido dos ponteiros do relógio ou anti-horário, conforme necessário.

DE Um den **Abstand** von der Tür zum Hauptrahmen auszurichten, drehen Sie die Schraube je nach Bedarf im oder gegen den Uhrzeigersinn.

IT Per regolare lo **spazio** tra la porta e il telaio principale, avvitare o svitare la vite secondo necessità.

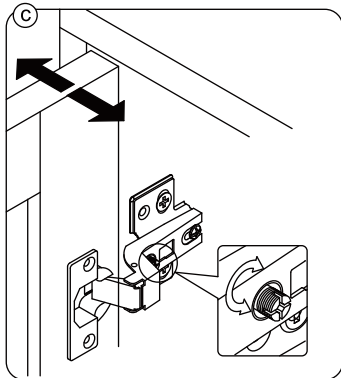

EN To adjust the door laterally adjust the screw as shown by turning clockwise or anti-clockwise.

FR Si vous souhaitez ajuster la porte **latéralement**, ajustez la vis comme indiqué en tournant dans le sens des aiguilles d'une montre ou dans le sens inverse des aiguilles d'une montre.

ES Para ajustar la puerta **lateralmente** ajuste el tornillo tal y como se muestra girándolo en sentido horario y antihorario.

PT Para ajustar a porta lateralmente ajustar o parafuso, conforme indicado, rodando no sentido dos ponteiros do relógio ou no sentido anti-horário.

DE Um die Tür **seitlich** auszurichten, stellen Sie bitte die Schraube wie abgebildet durch Drehen im oder gegen den Uhrzeigersinn ein.

IT Per allineare la porta **lateralmente** regolare la vite come mostrato, avvitandola o svitandola.

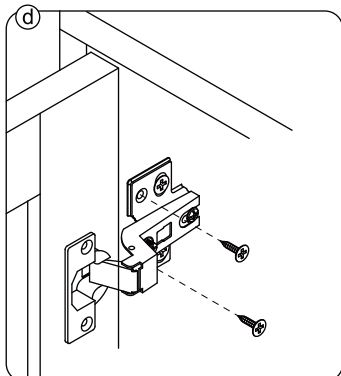

EN Please fix other screws

FR Merci de serrer les autres vis.









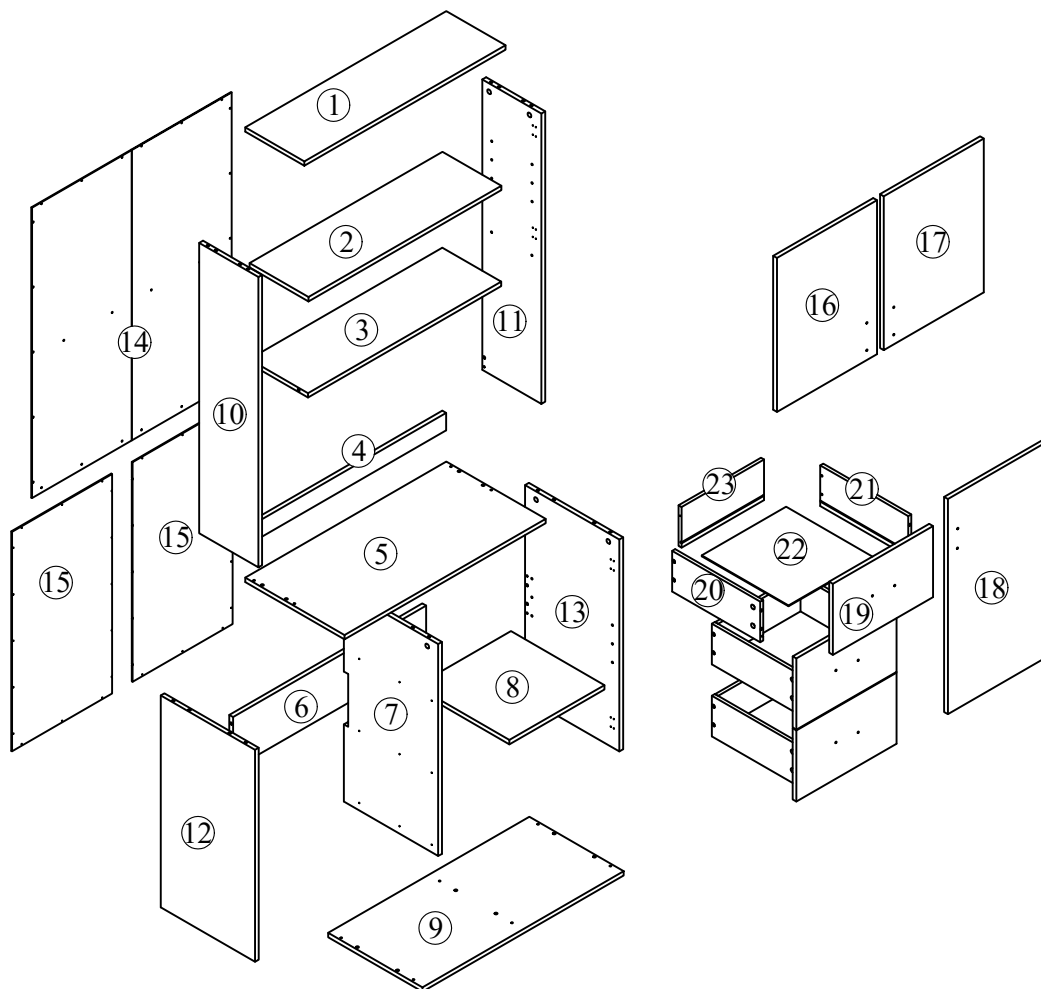

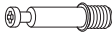

ES Fije los demás tornillos

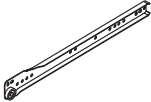
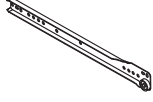
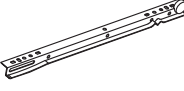
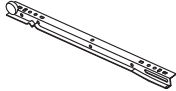
PT Por favor fixe os outros parafusos

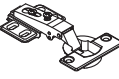
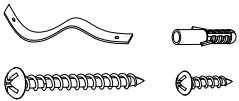
DE Befestigen Sie bitte die anderen Schrauben

IT Fissare le altre viti





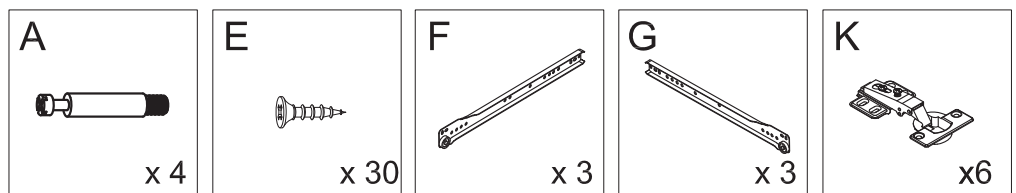
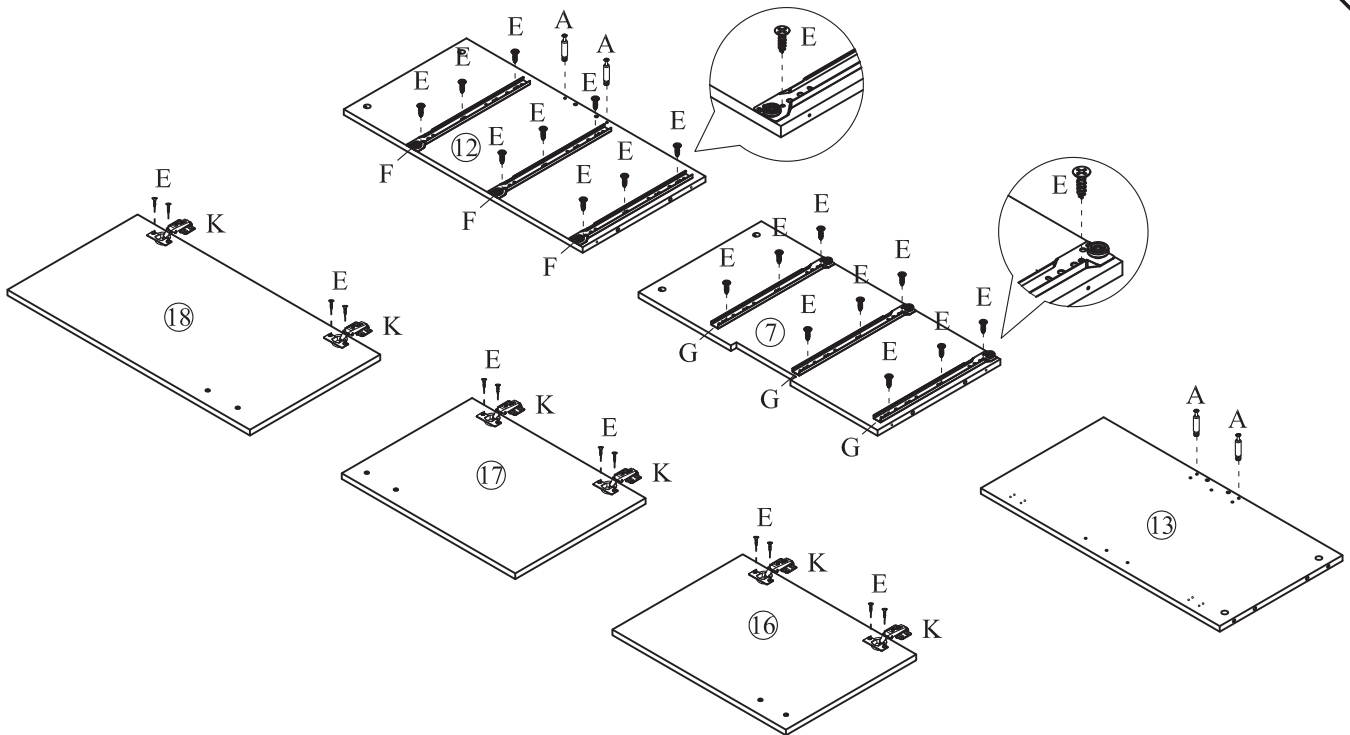
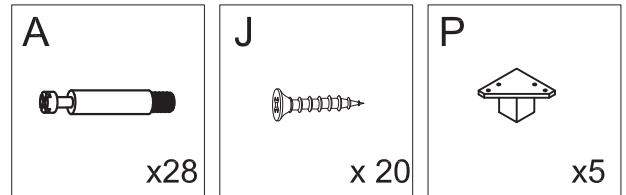
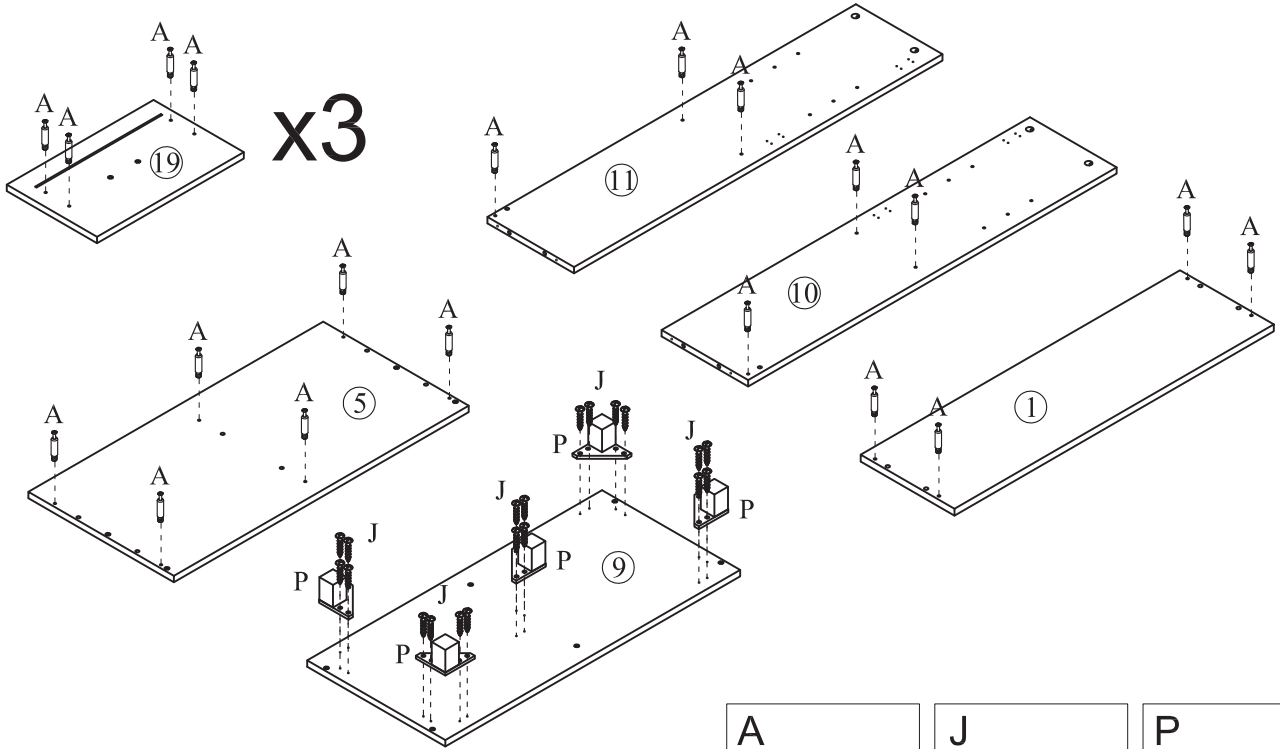

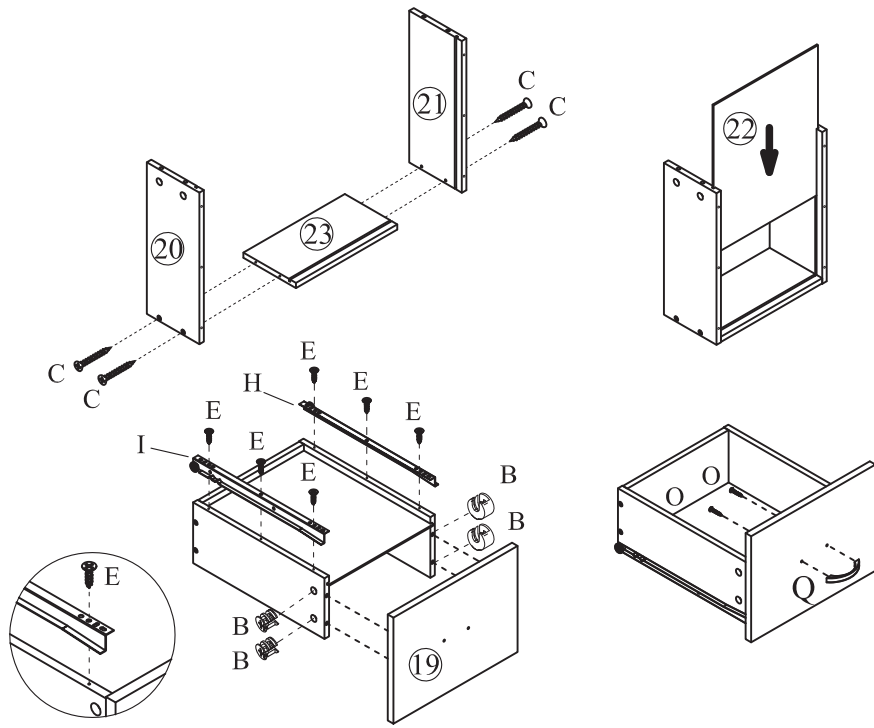
<p>A x 32</p>  <p>Φ6X35mm</p>	<p>B x 32</p>  <p>Φ15X9mm</p>	<p>C x 22</p>  <p>M4x35mm</p>	<p>D x 26</p>  <p>Φ8x30mm</p>	<p>E x 72</p>  <p>M3.5x14mm</p>
<p>F x 3</p> 	<p>G x 3</p> 	<p>H x 3</p> 	<p>I x 3</p> 	<p>J x 20</p>  <p>M4x16mm</p>
<p>K x 6</p> 	<p>L x 2</p>  <p>Φ4x30mm/Φ4x14mm</p>	<p>M x 8</p> 	<p>N x 51</p>  <p>M3x12mm</p>	<p>O x 12</p>  <p>M5x22mm</p>
<p>P x 5</p> 	<p>Q x 6</p> 			





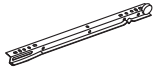
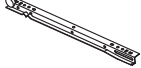

x3

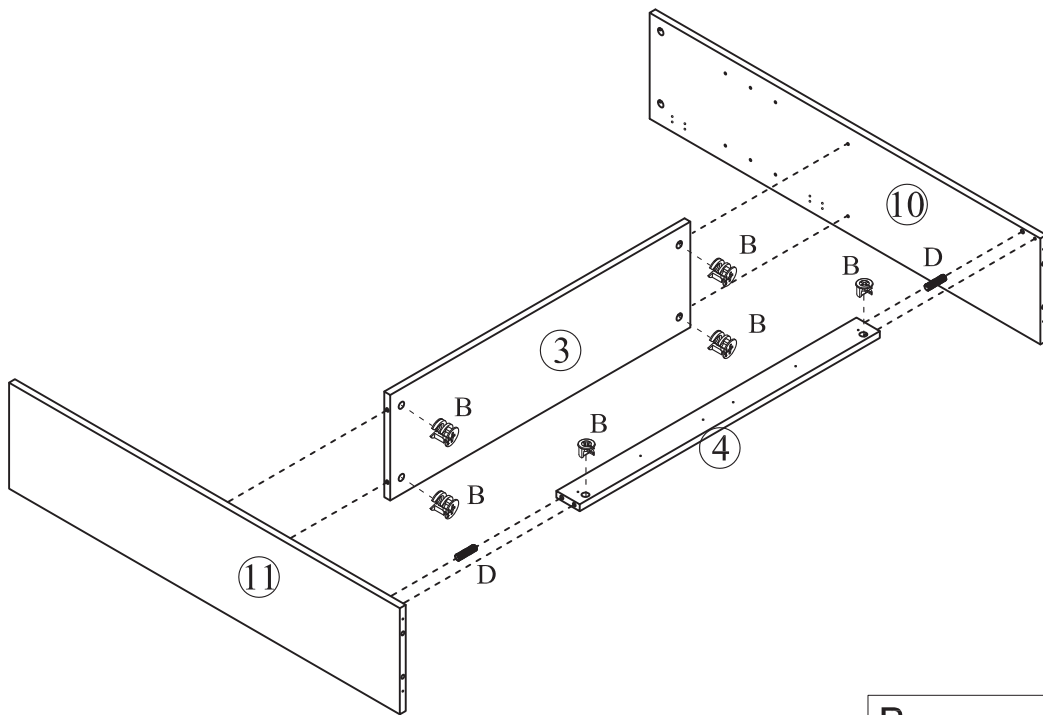
- | | | | | | | |
|---|---|--|--|---|--|--|
| <p>B</p>  <p>x12</p> | <p>C</p>  <p>x12</p> | <p>E</p>  <p>x18</p> | <p>H</p>  <p>x3</p> | <p>I</p>  <p>x3</p> | <p>O</p>  <p>x6</p> | <p>Q</p>  <p>x3</p> |
|---|---|--|--|---|--|--|



- | | |
|---|---|
| <p>B</p>  <p>x6</p> | <p>D</p>  <p>x2</p> |
|---|---|

