



















Assembly Instructions

Caution : You must read this before you proceed

Care & Maintenance

-   ● Not for commercial use. For residential use only .
-   ● Do not put hot items directly on furniture surface
-   ● Do not clean furniture with harsh cleansers or polish.
-   ● To obtain the longest lifespan of your outdoor products, minimizing exposure to direct sunlight is recommended.
-   ● Children should not climb or jump on the furniture.
-   ● Do not write on furniture without a padded barrier to protect the surface.
-   ● To obtain the longest lifespan of your outdoor products, avoid extended and lengthy exposure to rain, snow, and direct sunshine. Whenever possible cover the product and /or place under patio or awnings.
-   ● Stains may be removed with mild soap solution and damp cloth.
-   ● Dust and pick-up spills using a clean, non-colored, lint-free cloth .

Please look in the Seat Panel for hardware packs.

DINING CHAIR

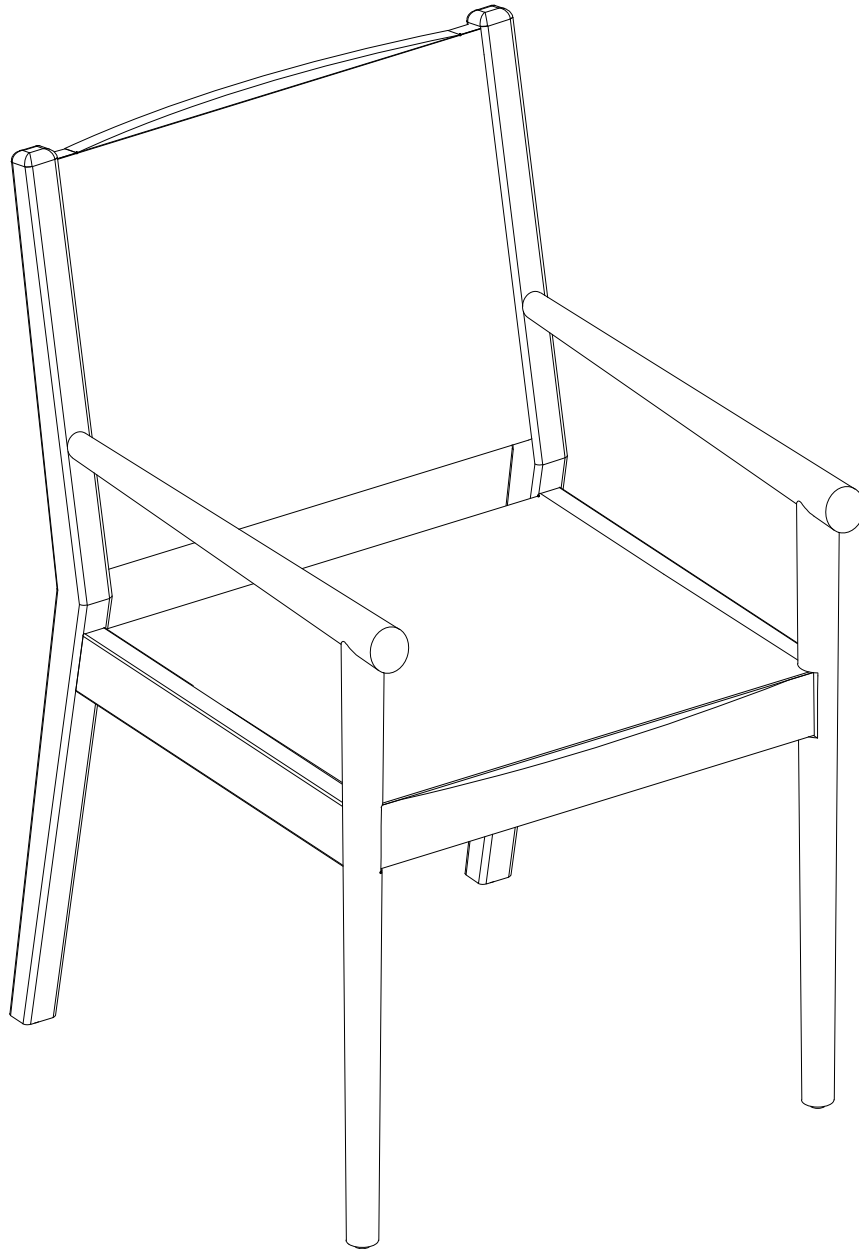

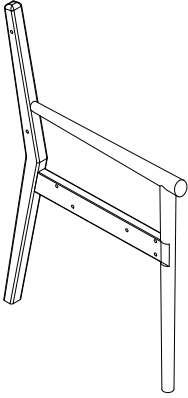
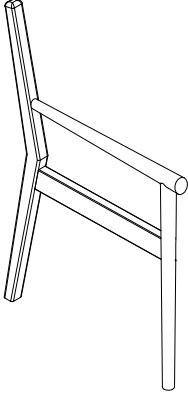
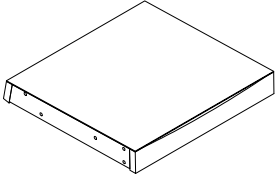
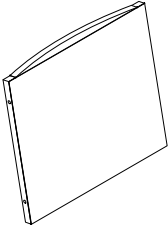
Label	Picture	Description	Qty
A		Right Leg Panel	1
B		Left Leg Panel	1
C		Seat Panel	1
D		Backrest Panel	1

Hardware

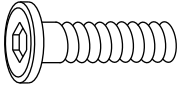
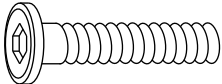
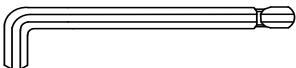
Label	Picture	Description	Qty
①		Bolt (M6 x 35mm)	11
②		Bolt (M6 x 45mm)	5
③		Allen Wrench	1

Assembly Preparation

Before Beginning Assembly:

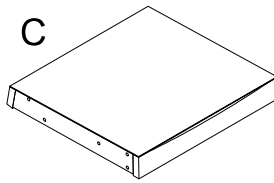
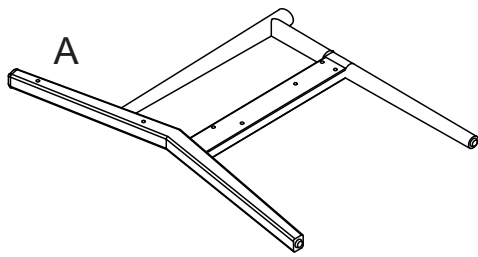

①  x 11

②  x 5

③  x 1

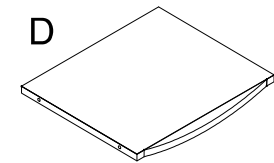
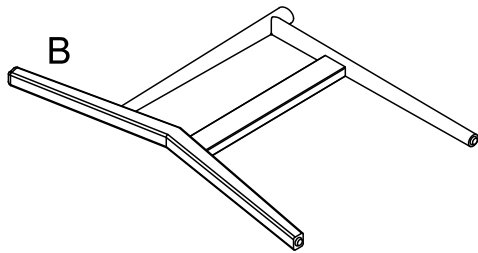

Read instructions, cover to cover.



Have 2 adults on hand for assembly.



Do not assemble on flooring or carpet.



Assemble on a clean non-marring surface (packing foam).



Save all packaging until finished.

Assembly Steps

OVERVIEW

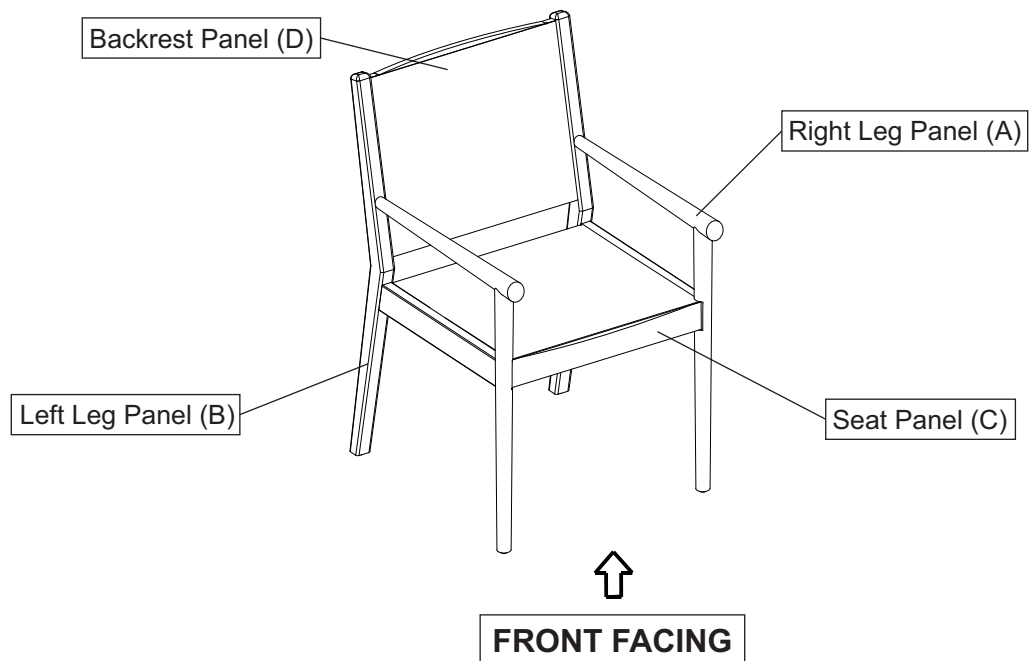

This Dining Chair has multiple parts and may require up to 30 minutes to assemble. To give you an overview of the Dining Chair parts, the above picture is to help you put the various parts into perspective. Please read through the instructions below to familiarise yourself with the parts and steps before assembly.

Step 1

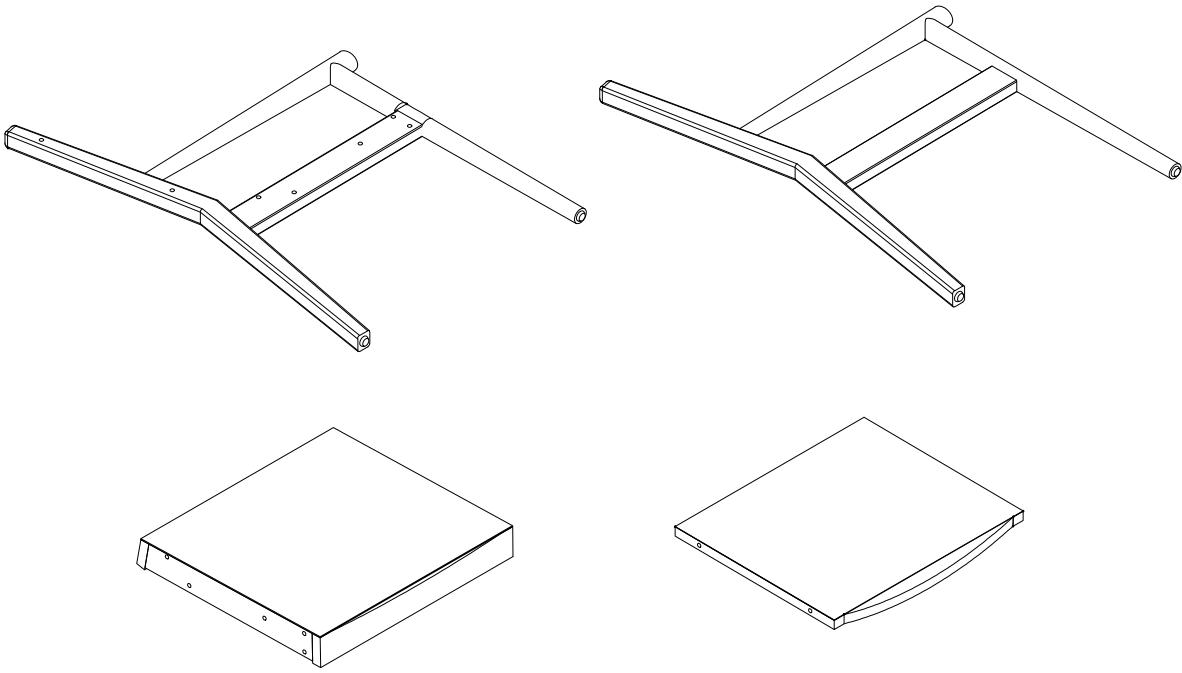

Unpack and place all parts on a clean, non-marring surface.

Step 2

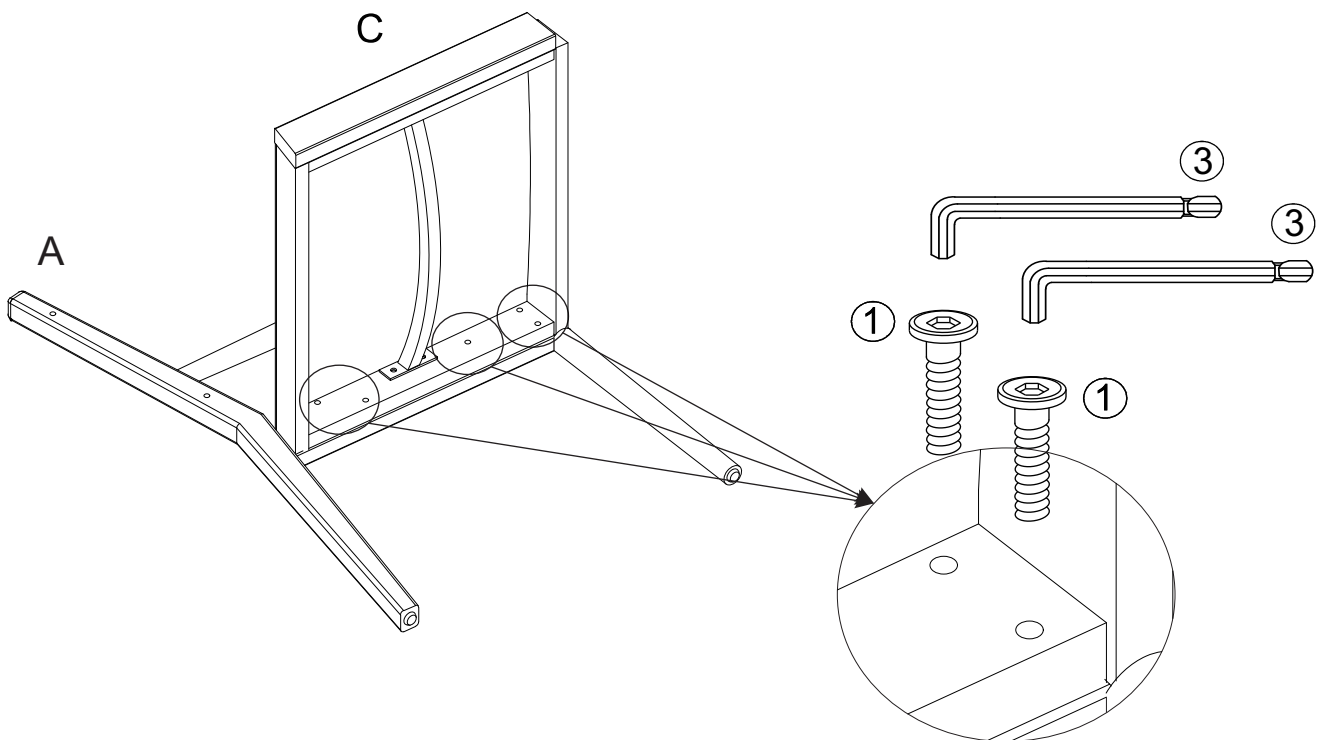

Attach the Right Leg Panel (A) to the Seat Panel (C) using Bolt (1) with Allen Wrench (3) as shown above.
Do not fully tighten the Bolts.

Step 3

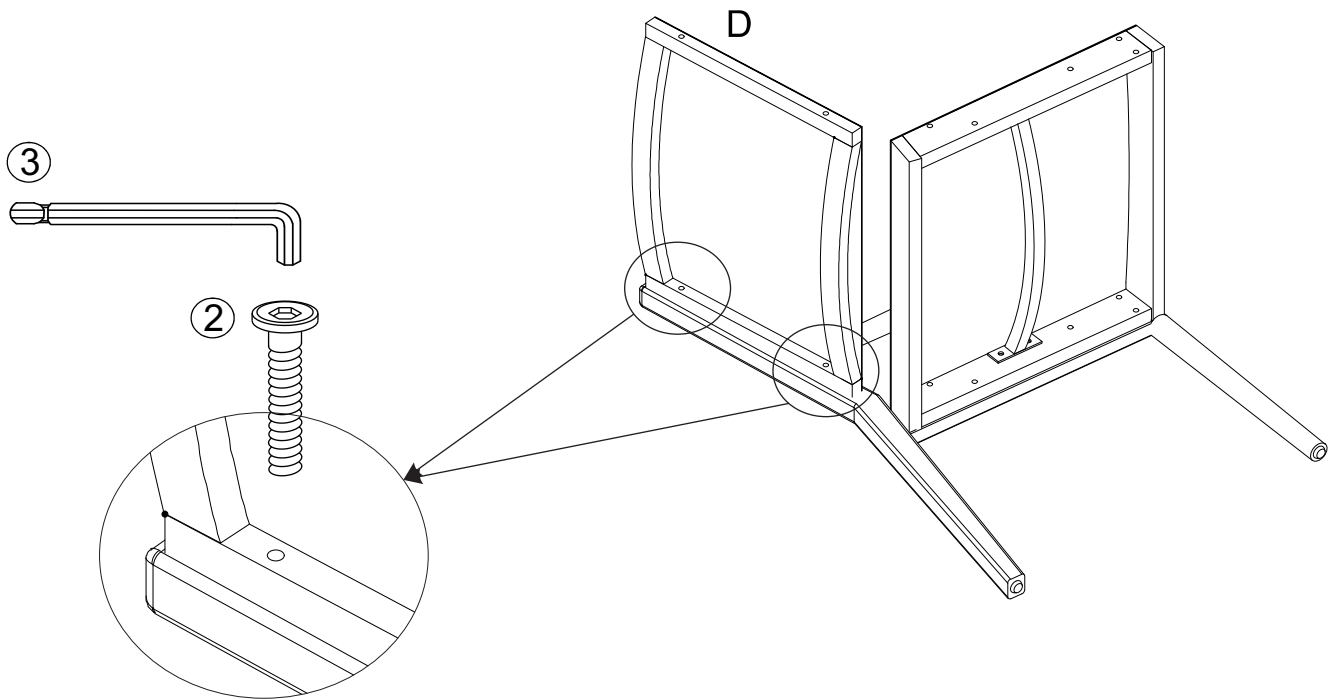

Attach the Backrest Panel (D) to the Right Leg Panel (A) using Bolt (2) with Allen Wrench (3) as shown above.
Do not fully tighten the Bolts.

Step 4

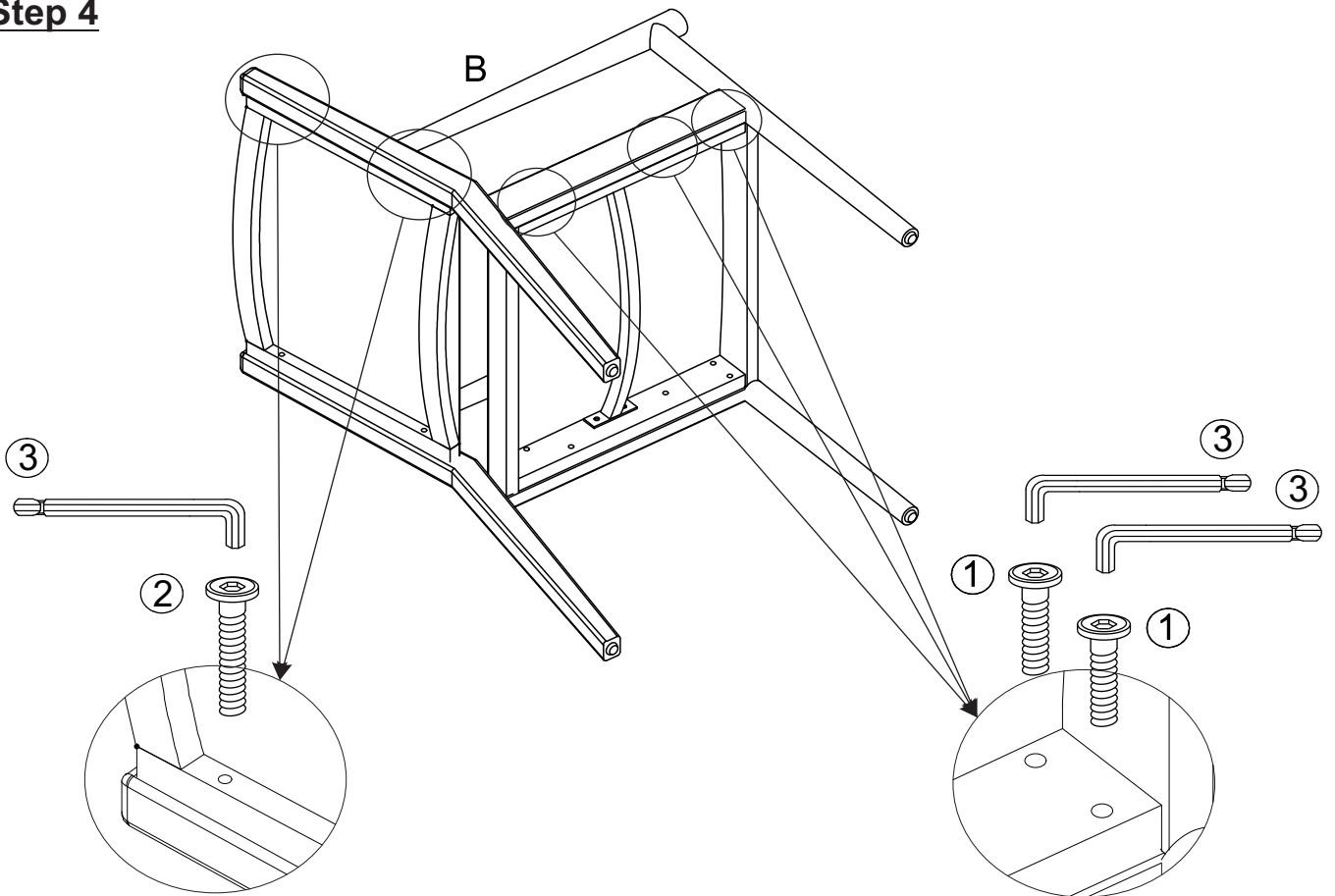

Repeat the same process in step 2 and step 3 with Left Leg Panel (B).
Do not fully tighten the Bolts.

Step 5

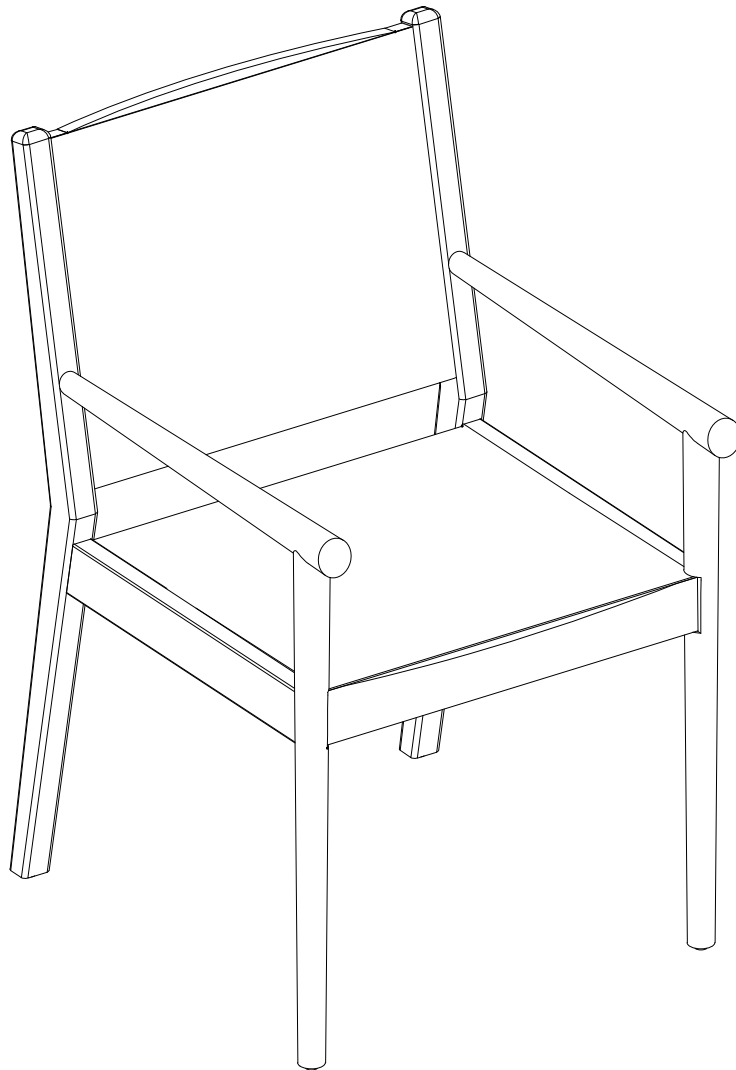

Inspect it and make sure all parts are adequately connected.

Gently and gracefully, sit onto the Chair.

This will help to align all the parts at all joint areas.

The get off the Chair and proceed to tighten the Bolts in a sequential manner.

When tightening the Bolts tighten sequentially.

DO NOT tighten any Bolts fully and then move on towards the next one.

If there are still wobbles, loosen the Bolts and execute this same process.

Your Dining Chair is ready for use.

This Dining Chair can only be used on a flat, level surface.