



















Assembly instructions

Caution: Please read instructions thoroughly before unpacking assembly parts. Sharp, exposed staple tips can cause injury, therefore, for your protection, please remove any exposed staples used in packing.

1. We recommend that you should assemble this product with the assistance of another person; this will make assembly easier, and will help to eliminate damage to the product or injury to persons during assembly.
2. Be sure to check all packing materials carefully for small parts that may have come loose inside the carton during shipment.
3. Please do not over tighten screws or bolts.
4. Please put all parts on a non-abrasive floor before assembly, and follow the assembly steps to assemble your newly purchased product correctly and efficiently.

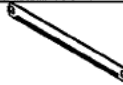
Hardware Bag for 5/0 Poster Headboard (163-140)			
1		ALLEN KEY (4MM*L57*22MM)	1pc
2		BOLT(Ø5/16"*18*2")	8pcs
3		SPRING WASHER (Ø5/16"*Ø13*1.2MM)	8pcs
4		FLAT WASHER (Ø5/16"*Ø19*1.8MM)	8pcs
Hardware Bag for 5/0 Poster Footboard (163-141)			
5		ALLEN KEY (4MM*L57*22MM)	1pc
6		BOLT(Ø5/16"*18*2")	8pcs
7		SPRING WASHER (Ø5/16"*Ø13*1.2MM)	8pcs
8		FLAT WASHER (Ø5/16"*Ø19*1.8MM)	8pcs
9		WOOD SCREW(#8*1")	6pcs
Hardware Bag for 5/0-6/6 Poster Rails (163-142)			
10		ALLEN KEY (4MM*L57*22MM)	1pc
11		BOLT(Ø5/16"*18*1")	8pcs
12		SPRING WASHER (Ø5/16"*Ø13*1.2MM)	8pcs
13		FLAT WASHER (Ø5/16"*Ø19*1.8MM)	8pcs

No.	Parts List	Q'Ty
A	 Headboard Panel	1pc
B	 L/R Headboard Post	2pcs
C	 Footboard Panel	1pc
D	 L/R Footboard Post	2pcs
E	 Poster Rails	2pcs
F	 Bed Slat	3pcs
G	 Slat Support Leg	6pcs

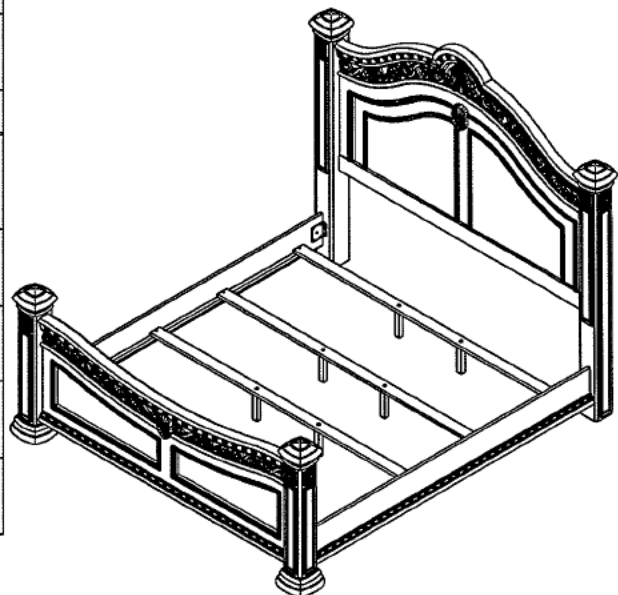

Assembly instructions

