

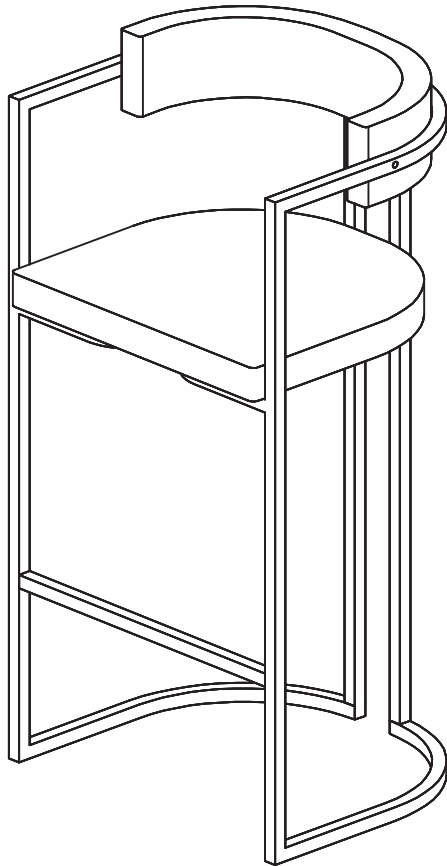





ASSEMBLY INSTRUCTION





Counter Stool



Component List

LABEL		DESCRIPTION	QTY
1		Right leg	1
2		Left leg	1
3		Beams	1
4		Seat	1
5		Back	1

Hardware List

LABEL		DESCRIPTION	QTY
A		Screw	6
B		Bolt M6*12mm	4
C		Bolt M6*35mm	6
D		Bolt M6*40mm	4
E		Allen Wrench	1

