

WARNING

- * Switch off the main electrical supply from the main fuse box / circuit breaker before installation.
- * Inspect item carefully before attempting to install.
- * If there is any damages or obvious defects, do not install.
- * Item may not be returned once it has been installed.











CARE AND MAINTENANCE

- * To clean the outside of the fixture, use a dry or slightly dampened clean cloth (use clean water, never a solvent) to wipe the surface of the fixture.
- * To clean the inside of the fixture, first disconnect power to the fixture by turning off the circuit breaker or by removing the fuse at the fuse box. Next, use a dry or slightly dampened clean cloth (use clean water, never a solvent) to wipe the interior surface of the fixture.
- * Do not use any cleaners with chemical, solvents or harsh abrasives. Use only a dry soft cloth to dust or wipe carefully.

NOTICE& IMPORTANT SAFETY INSTRUCTIONS

- ** WE RECOMMEND INSTALLATION OF THIS LIGHTING FIXTURE BE DONE BY A LICENSED ELECTRICIAN **
- * Please make sure that you have all parts indicated before you begin assembly of this item
- * This item should be assembled on a soft surface to prevent scratching the finish during assembly
- * To reduce the risk of fire, electrical shock or injury to persons or property, please follow the guideline below for safe use and installation
- *The external flexible cable or cord of this lamp cannot be replaced
If the cord is damaged, the lamp shall be destroyed

Part List and Hardware List

PIECE	DESCRIPTION	PICTURE	QUANTITY	PIECE	DESCRIPTION	PICTURE	QUANTITY
A	mounting screw		2X	F	chain		1X
B	mounting plate		1X	G	Canopy		1X
C	ground screw		1X	H	screw collar loop		1X
D	Wire Nut		3X	J	shade		1X
E	screw collar nut		1X	K	Bulb		3X

Product Dimensions: 16"Lx16"Wx16.5-72.5"H

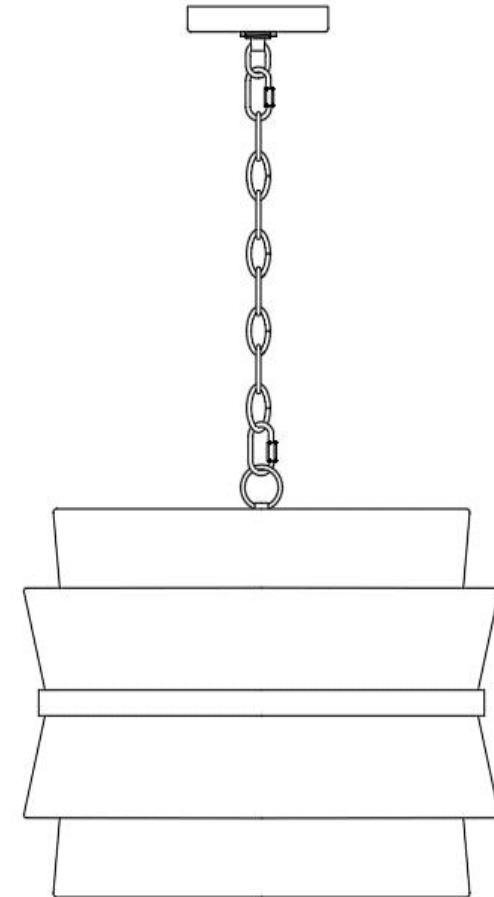

PREPARATION

- * Before beginning assembly of product, make sure all parts are present. Compare parts with package contents list and hardware contents list.
- * If any part is missing or damaged, do not attempt to assemble the product.
- * Estimated Assembly Time: 20 minutes.
- * Tools Required for Assembly (not included): Screwdriver, Junction box

NOTE: PLEASE USE ON/OFF TYPE "A" BULB MAX 40-WATT OR LED BULB MAX 9-WATT, THERE IS LED 8-WATT BULB IN THE BOX

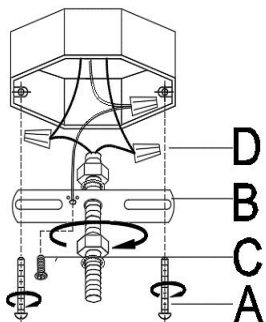

Step 1: Secure mounting plate (B) to outlet box with mountings crews (A).

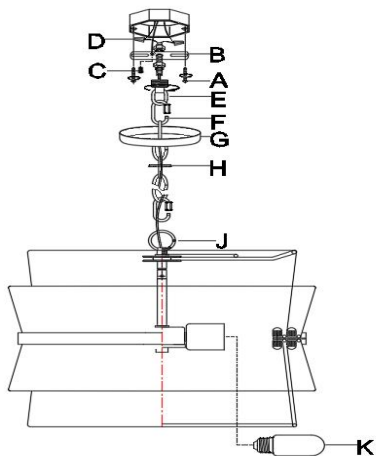

Step 2: Lock the screw collar nut (E) onto the mounting plate (B). Use a chain (F) to pass through the canopy (G) and lock it with a threaded collar (H). Hang the upper end of the chain (F) on the screw collar nut (E) and the lower end on the lifting ring of the shade (J).

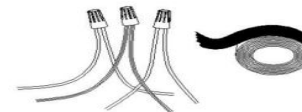

Step 3: Wire connection Connect fixture neutral wire (ribbed) to the outlet box neutral wire (usually white) using a wire nut.

Connect fixture hot wire (smooth with markings) to the outlet box hot wire (usually black) using a wire nut.

Grounding Instructions:

Wrap ground wire from outlet box around green ground screw (B) on mounting bracket, no less than 2" from wire end. Tighten ground screw. If fixture is supplied with a ground wire, connect to outlet ground wire with a wire connector.

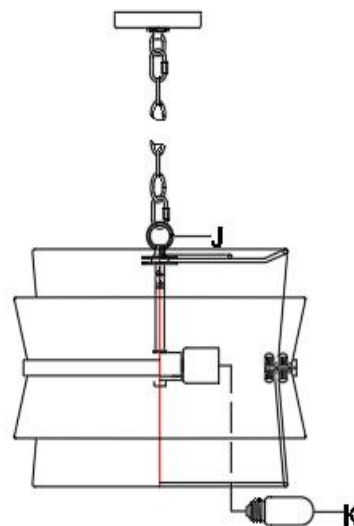

Step 4: Insert the bulb (K) into the socket of the shade (J),