

15'

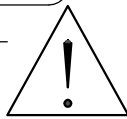

1

A

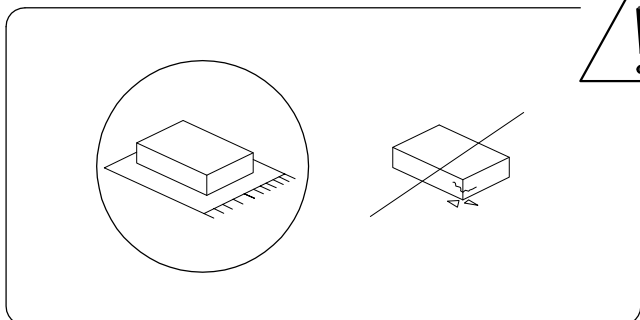
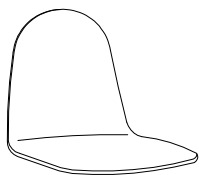

x 1

B



x 1

A

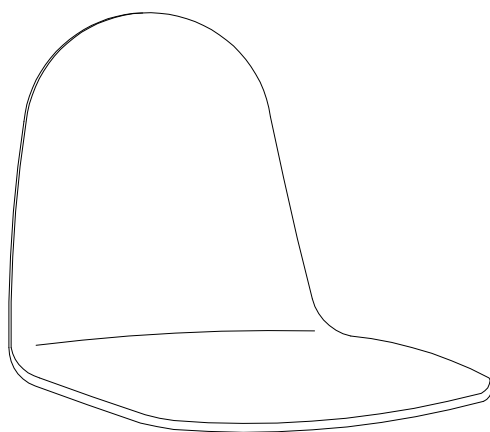

B

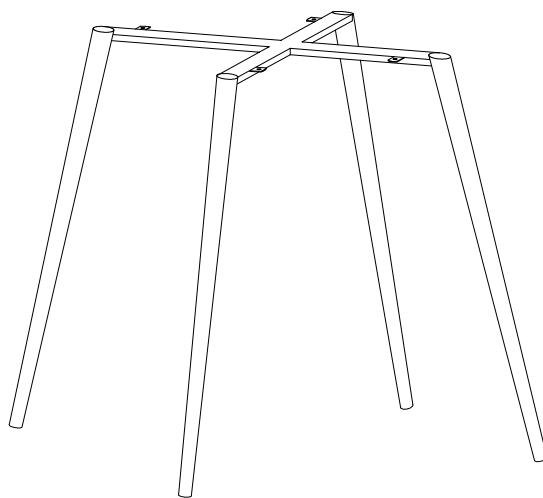

C

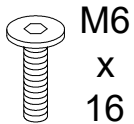

M6
x
16

x 4

D

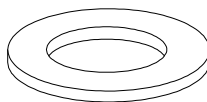

x 4

E

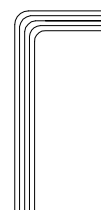

x 1

1

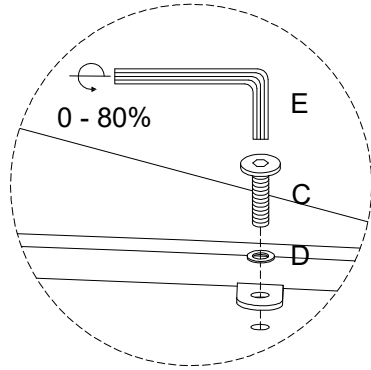
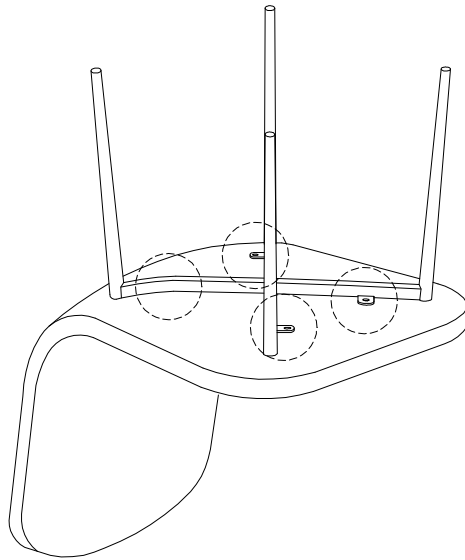
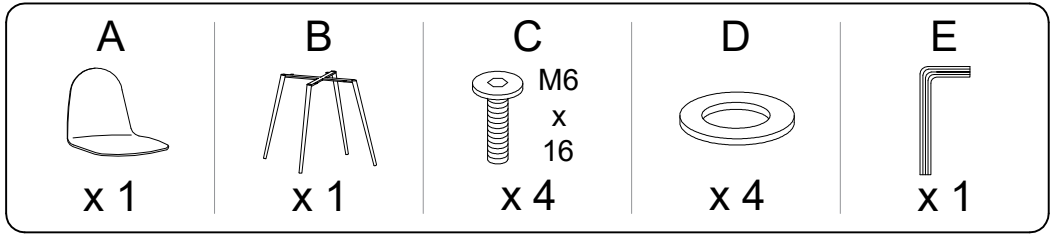

2

