

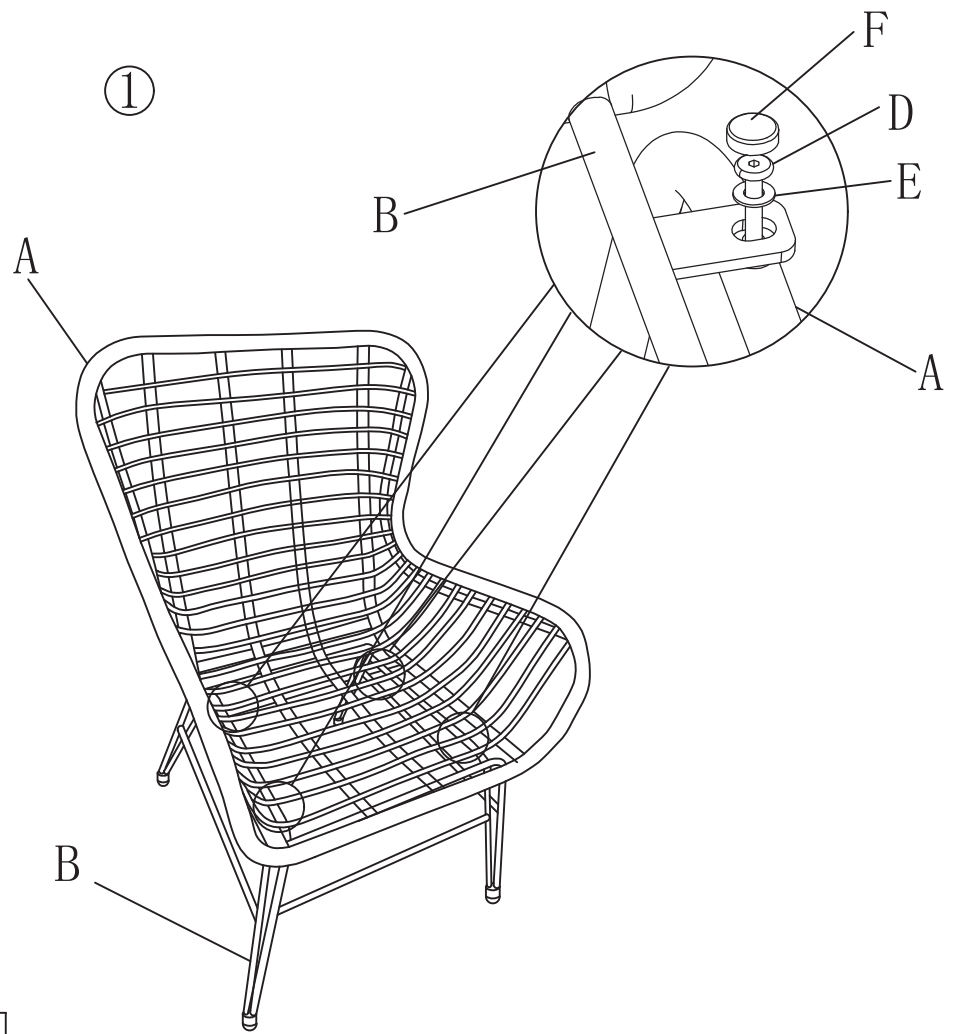

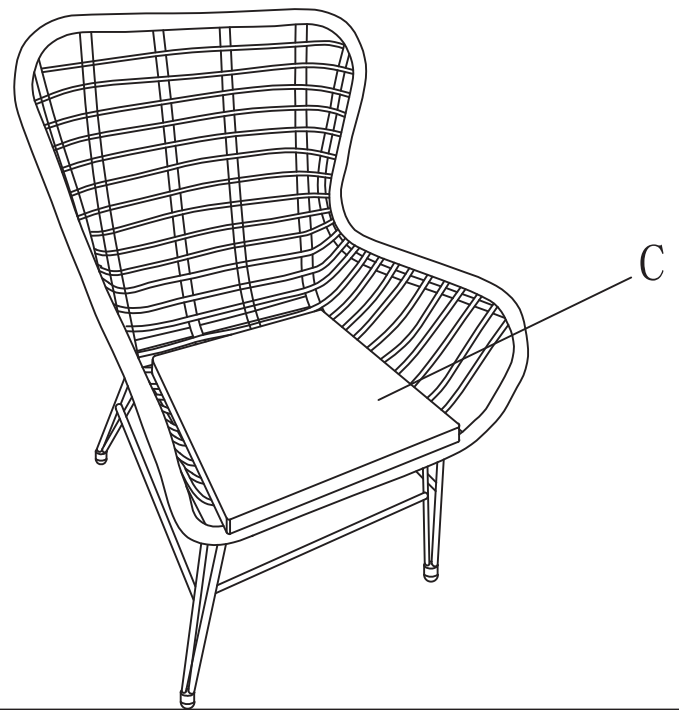



21x29.7cm

- ES** MANUAL DE INSTRUCCIONES
- PT** MANUAL DE INSTRUÇÕES
- FR** MANUEL D'INSTRUCTIONS
- IT** MANUALE DI ISTRUZIONI
- EN** INSTRUCTION MANUAL

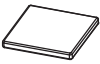

②



A		1
B		1
C		1
D		4
E		4
F		4
G		1