

Instruction Manual

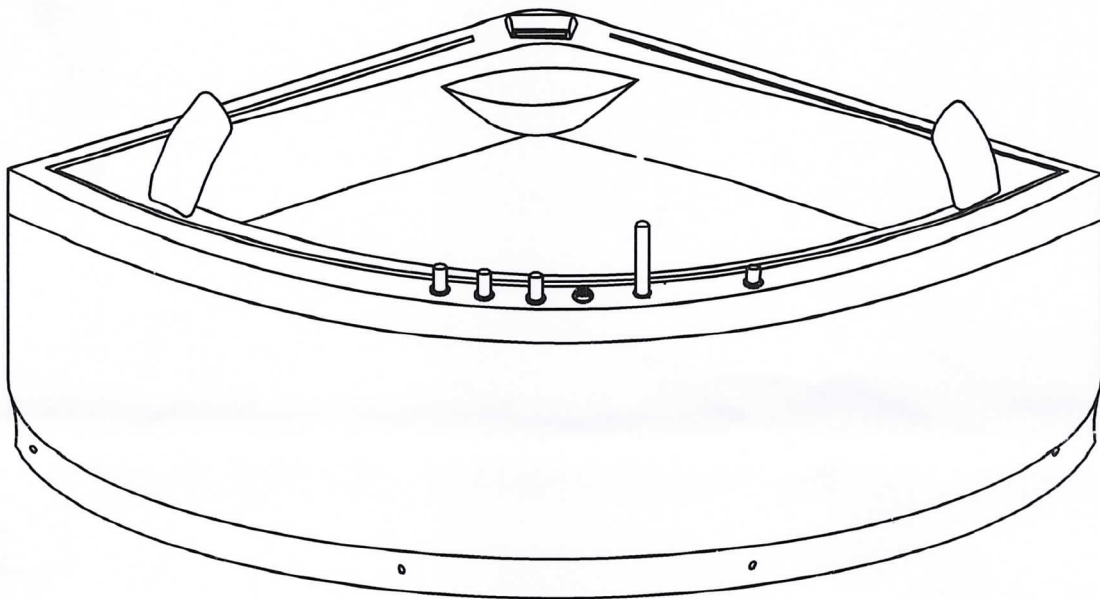

RL-6200

SIZE:1660×1660×600

Preparations

Dear Customers:

Thank you for purchasing our products. Prior to the installation and initial use of the bathtub, please read carefully the instructions that can be helpful when using this product.

We will not be liable for improper use of our products.

Our products are subject to constant development of our product, because there may be changes in design and use other components. If you have any questions, please contact us or distributors. We will help you much

WARNING

1. People who suffer from heart disease, hypertension and diabetes should not use a steam shower or hot bath. (It is suggested that children should be accompanied by an adult to take a bath)
2. Do not take bath after you drink alcohol or have taken excessive Sports.
3. The bathing water should be below 45 ° C during the recommended temperature is 30 ° C -38°
4. Don't take a bath for a long time. Recommended time: Suggested time: 15-21 minutes
5. We reserve the right to change information at any time.
6. Also settings, configurations and details of products are subject to change.
7. For maintenance, you should contact the engineers, appointed by the dealer. Do not fix by yourself and do not break down, otherwise the supplier is not liable for damages that may occur.

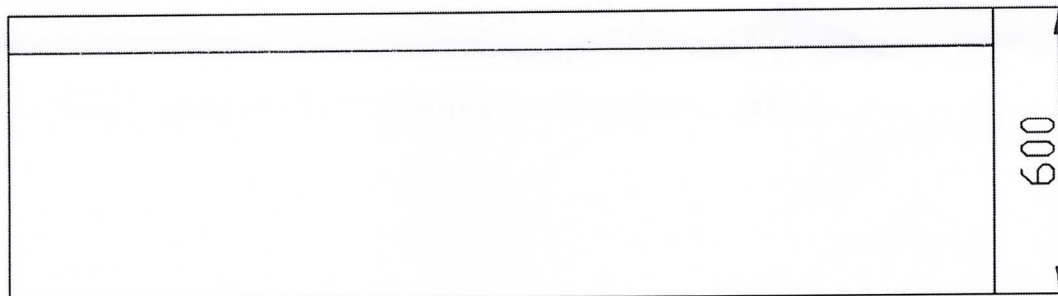
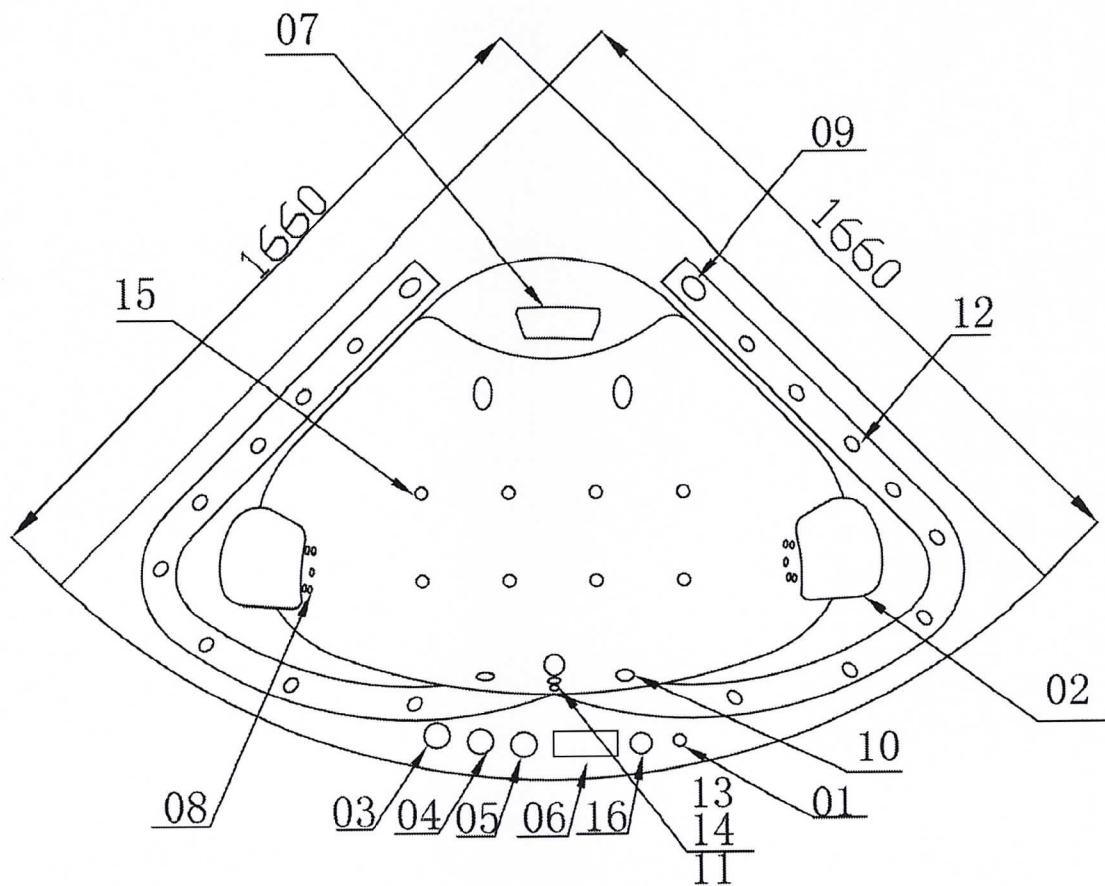

NO.	Description	Qty	NO.	Description	Qty
01	Adjustment switch	1pc	9	small jet with light	2pcs
02	pillow	2pc	10	big water jets	4pcs
03	Divert knob	1pc	11	underwater light	1pc
04	Cold water volume	1pc	12	light	18pcs
05	hot water volume	1pc	13	Floor drain	1pc
06	computer panel	1pc	14	water circulation	1pc
07	waterfall	1pc	15	bubble	8pcs
08	small water jets	10pcs	16	hand shower	1pc

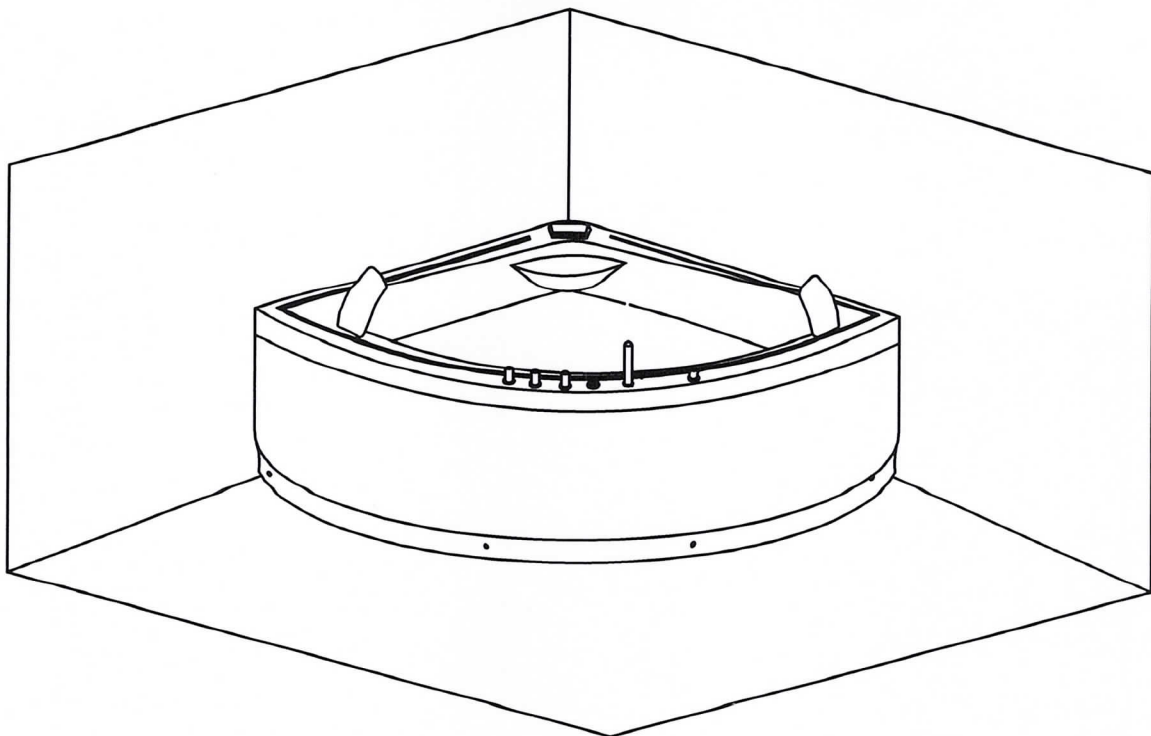
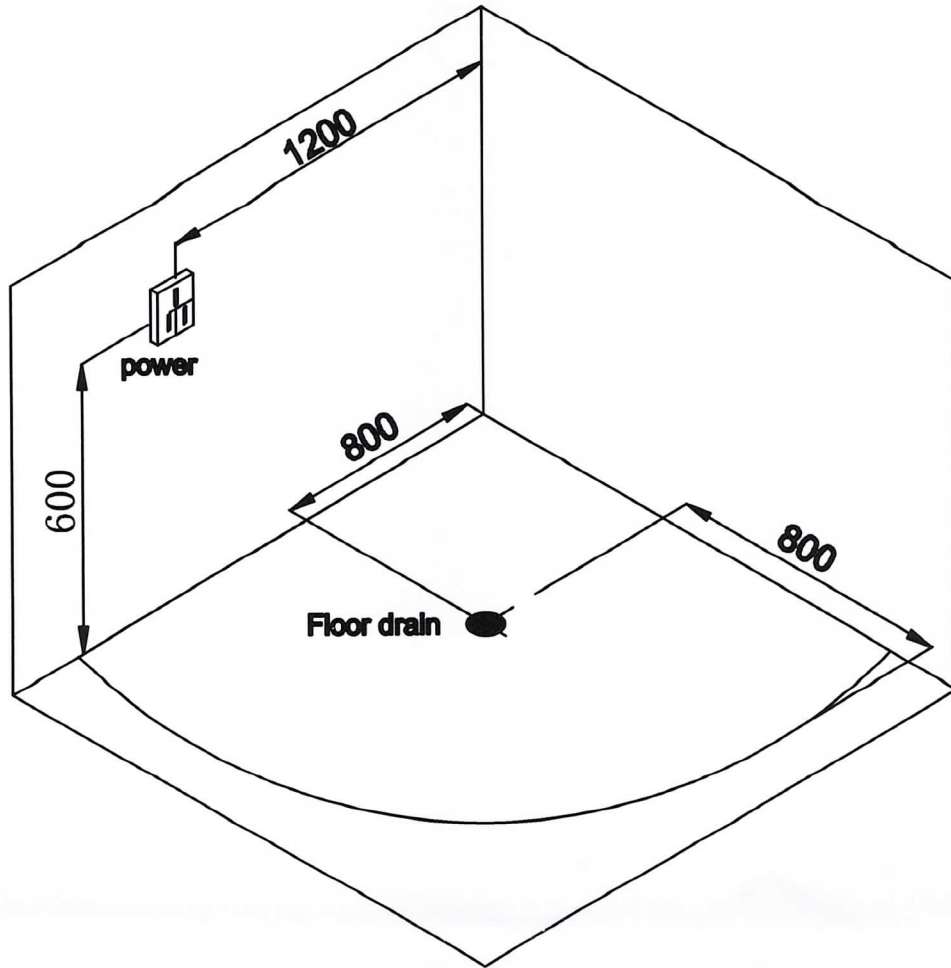

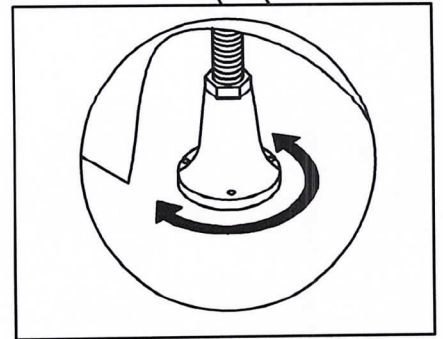
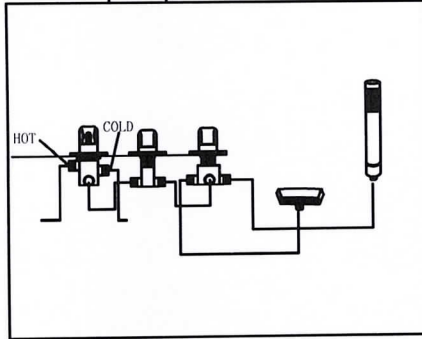
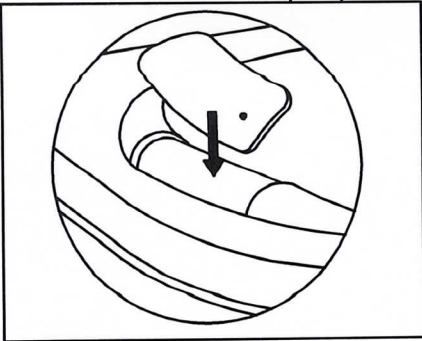
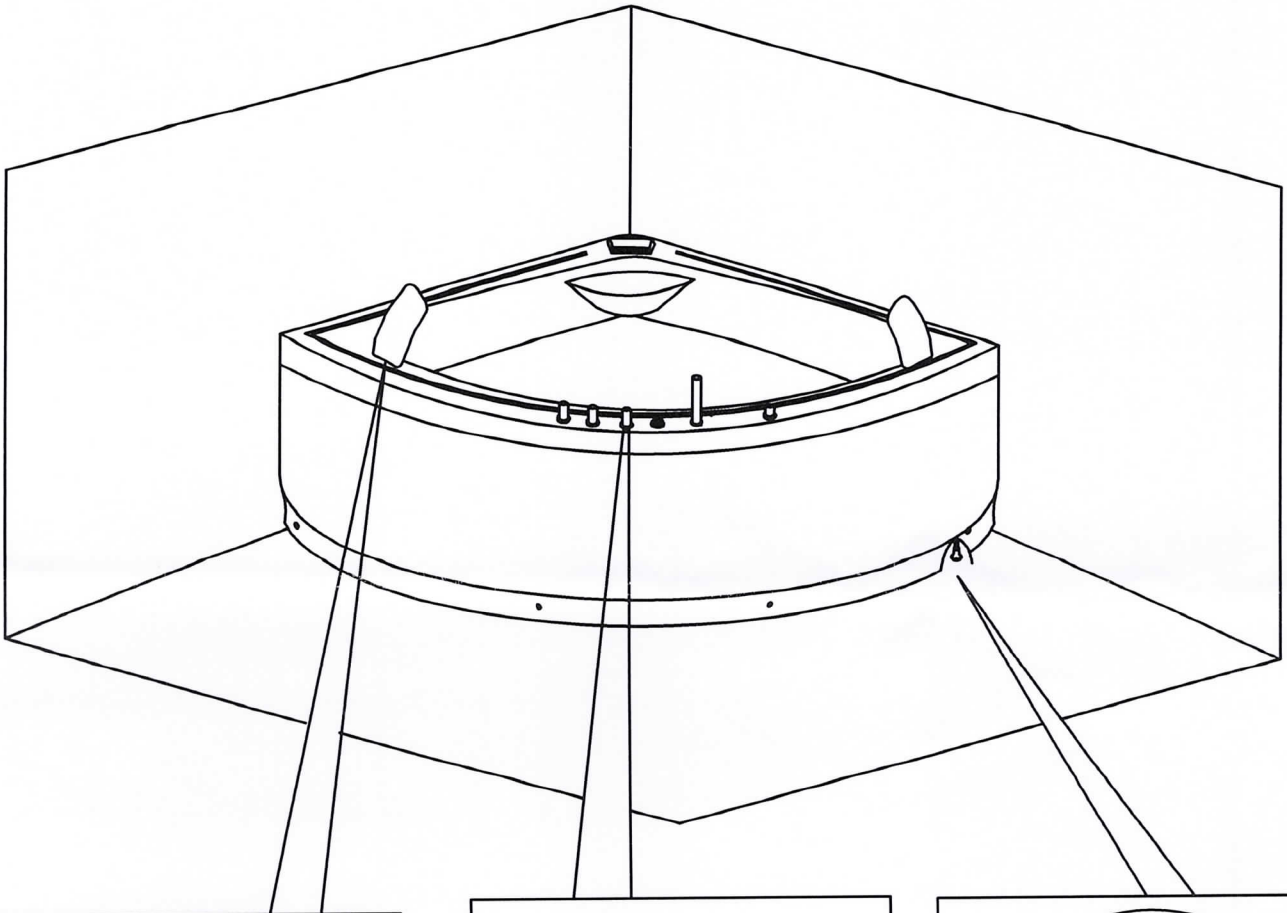

IMPORTANT NOTES:

1. The installation must be performed by a technician qualifizeirten
2. The electronic parts should be well grounded, otherwise the manufacturer is not responsible for disruptions and damage.
3. The installer is responsible for ensuring that the hot tub with plenty of FI-hedging is installed correctly.
4. For the functions that could not be activated after the above instructions, please contact the authorized technician or the local dealer.
5. If you do not use the product for a long time, please disconnect the main power and turn off the water.
6. The hot tub is absolutely connect with an aqua-stop, this prevents leakage in case of rupture of a pressure hose, water.
7. It should be used only drinking water for bathing. Rain water or well water, destroy valves and piping are not good.

Cleaning & Maintenance

1. During transit can loosen screws. Tighten all screws and check all connections before the pool building.
2. Removal with a soft cloth with mild detergent possible contamination from the surface, the metal parts (valves, etc), you can polish with a cloth.
3. The lime can be wiped clean with warm citric acid or vinegar with a soft cloth. Do not use acetone and / or ammonia-based cleaners.
4. Do not clean the tub and accessories with a hard or coarse material to prevent scratches.
5. Clean the tub and accessories come with gasoline to prevent damage.
6. It is not recommended to have water for a long time in the bath tub or use it for laundry washing. Allow the water to the bath off and disconnect the power supply.

7. Power should be strong enough and be grounded
8. To ensure your safety must be a professional engineer that the grounding line is well grounded and an RCCB fitted during installation.

Important:

Bathing should not go untreated into the environment!

Waste water (sewage) must to be connected to public sewer or an approved sewage treatment plant.