

NOTICE

- *Please make sure that you have all parts indicated and they are in good condition before you begin assembly of this item. Refer to part list and hardware list below for guidance.
- *This item should be assembled on a soft surface to prevent scratching the finish during assembly.
- *This item may require periodic tightening.
- *If you are having difficulty, our friendly Customer Care team is always here to help.











PREPARATION

- *Before beginning assembly of product, make sure all parts are present. Compare parts with part contents list and hardware contents list.
- *If any part is missing or damaged, do not attempt to assemble the product.
- *Estimated Assembly Time: 30minutes.
- *Tools Required for Assembly (included): Allen Key

CARE AND MAINTENANCE

Store outdoor furniture indoors or cover well when not in use. Remove wooden furniture from standing water. Dust regularly with small brush or vacuum. Spills should be taken care of immediately before they harden or stain with a slightly dampened sponge.

Part List and Hardware List

PIECE	DESCRIPTION	PICTURE	QUANTITY
A	Half Chair Bucket		1
B	Half Chair		1
C	Base		2
D	Cushion		1
HW1	Bolt	 D0.43"*1.61"	1
HW2	Bolt	 D0.43"*0.91"	2
HW3	Washer	 D0.51"/0.26"*0.04"	12
HW4	Nut	 D0.43"	10
HW5	Allen Key		1
HW6	Wrench		1

Product Dimensions:
Dia50.67"x37.78"

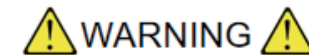

Weight Capacity: 250LBS
Warning: Do not stand on the table
Warning: Do not over torque bolts

PREPARATION

- *Before beginning assembly of product, make sure all parts are present. Compare parts with part contents list and hardware contents list.
- *If any part is missing or damaged, do not attempt to assemble the product.
- *Estimated Assembly Time: 30 minutes.
- *Tools Required for Assembly (included): Allen Key
- *If you are having difficulty, our friendly Customer Care team is always here to help. Please email customersupport@safavieh.com
- *Gradually tighten bolts in a star pattern: tighten one bolt and then the one opposite from it until all bolts are tightened.

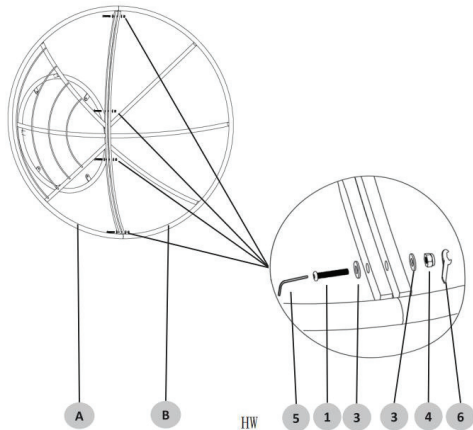

STEP1:

Attach Half Chair Bucket with Connect Circle(A)and HalfChair Bucket(B)by using 4 Long bolts(1),8 Washers(3)and 4 Nuts(4)with Wrench(6)and Allen wrench(5).(NOTE:Use 1 Washer(3)on 1L ong bolt(1)and get the Long bolt(1) through each hole. Then place another Washer(3)and Nut(4)on the end of this Long bolt (1).

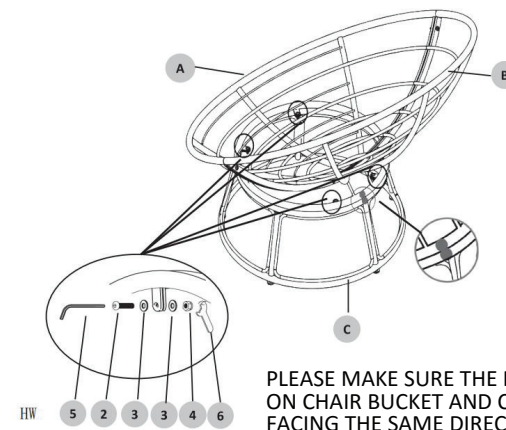

PLEASE MAKE SURE THE RED DOT STICKER ON CHAIR BUCKET AND CHAIR BASE ARE FACING THE SAME DIRECTION.

STEP2:

Attach Base(C)to Bottom Seat(A)by using 4 Short bolts(2),8 Washers(3)and4 Nuts((4)with Wrench(6)and Allen wrench(5).(NOTE: Use one Washer(3)on one Short bolts(2)and get the Short bolts(2) through each hole. Then place another Washer (3)and Nut (4) on the end of this Short bolts(2).

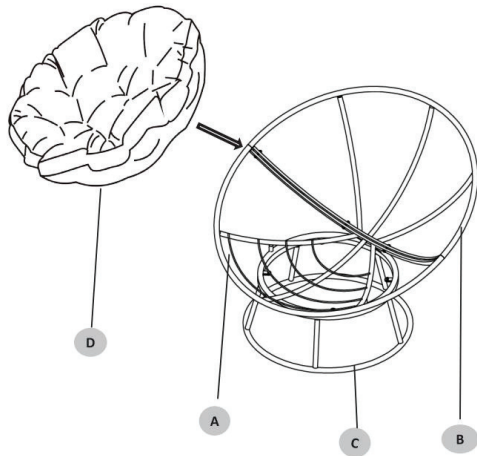

STEP3:

Place Cushion (D)on the seat of chair. Finished!