



**INSTRUCTIONS D'ASSEMBLAGE
ASSEMBLY INSTRUCTIONS**

**TABLE D'APPOINT -
GRIS CIMENT ET METAL CHROME**



**ACCENT TABLE -
GREY CEMENT WITH CHROME METAL**



**POUR DE L'ASSISTANCE OU POUR COMMANDER
DES PIÈCES CONTACTEZ NOTRE DÉPARTEMENT
DE SERVICE À LA CLIENTÈLE.**

**FOR ASSISTANCE OR TO ORDER PARTS
CONTACT OUR CUSTOMER SERVICE DEPARTMENT**

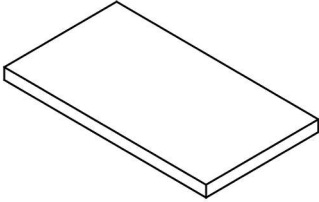
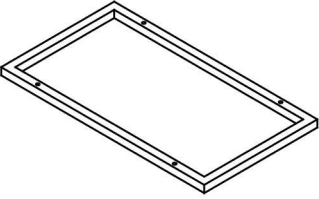
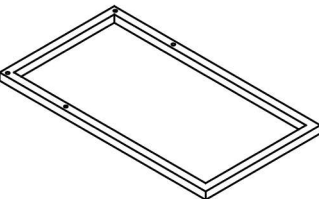
LISTE DES PIÈCES
PARTS LIST

PIÈCE / PART #	IMAGE	DESCRIPTION	QTY / QTÉ
1		TABLE TOP SURFACE DE TABLE	1
2		TOP FRAME CADRE DE SURFACE	1
3		BOTTOM FRAME CADRE DU BAS	1
4		FRONT FACING LEFT LEG PATTE AVANT GAUCHE	1
5		FRONT FACING RIGHT LEG PATTE AVANT DROITE	1

LISTE DES PIÈCES DE MONTAGE
HARDWARE LIST

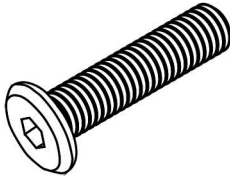
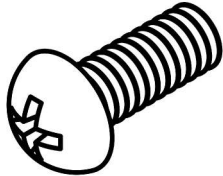
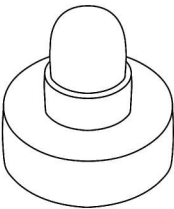
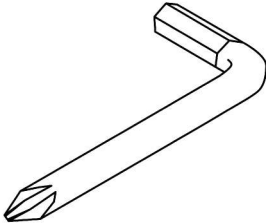
PIÈCE / PART #	IMAGE	DESCRIPTION	QTY / QTÉ
A		ASSEMBLING SCREW - Ø3/8" X 1 1/4" VIS D'ASSEMBLAGE - Ø3/8" X 1 1/4"	4
B		ASSEMBLING BOLT - Ø1/4" X 7/8" BOULON D'ASSEMBLAGE - Ø1/4" X 7/8"	4
C		ASSEMBLING BOLT - Ø1/8" X 1/2" BOULON D'ASSEMBLAGE - Ø1/8" X 1/2"	4
D		FLOOR PROTECTOR - Ø1/4" PROTECTEUR DE PLANCHER - Ø1/4"	4
E		HEX KEY CLÉ HEXAGONALE	1

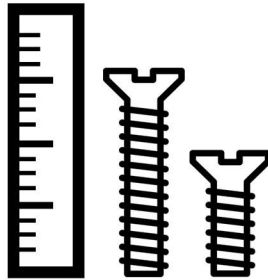

OUTIL DE VÉRIFICATION DE DIMENSIONS DES PIÈCES
HARDWARE DIMENSIONS VERIFICATION TOOL

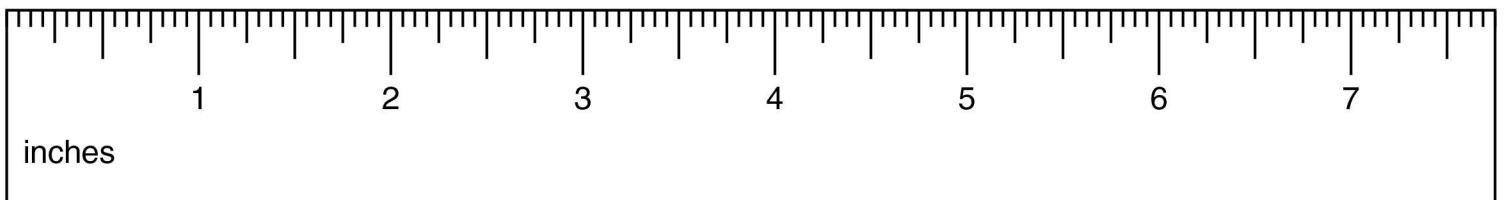

ÉTAPE / STEP 1

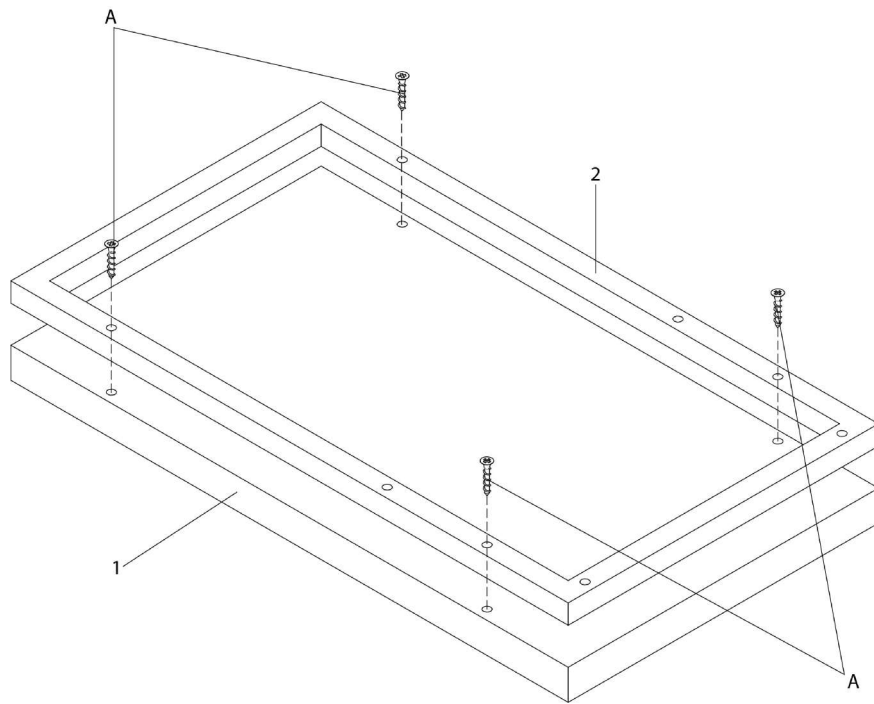

ÉTAPE / STEP 2

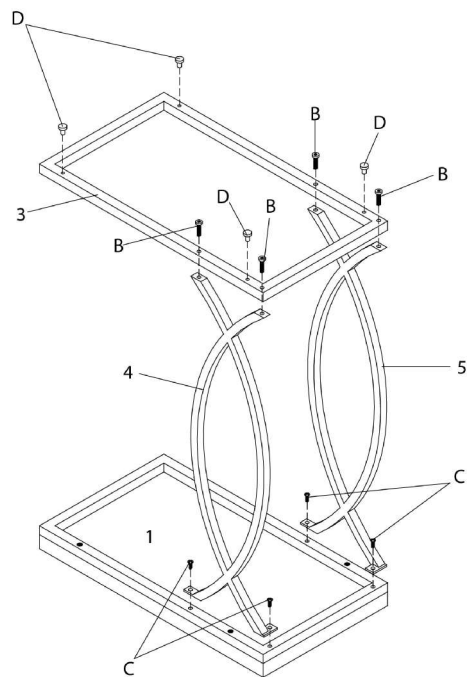

ÉTAPE / STEP 3

