











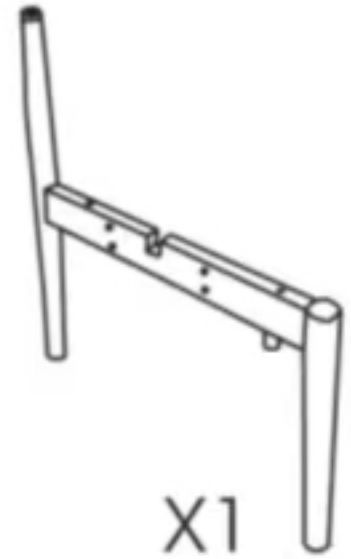

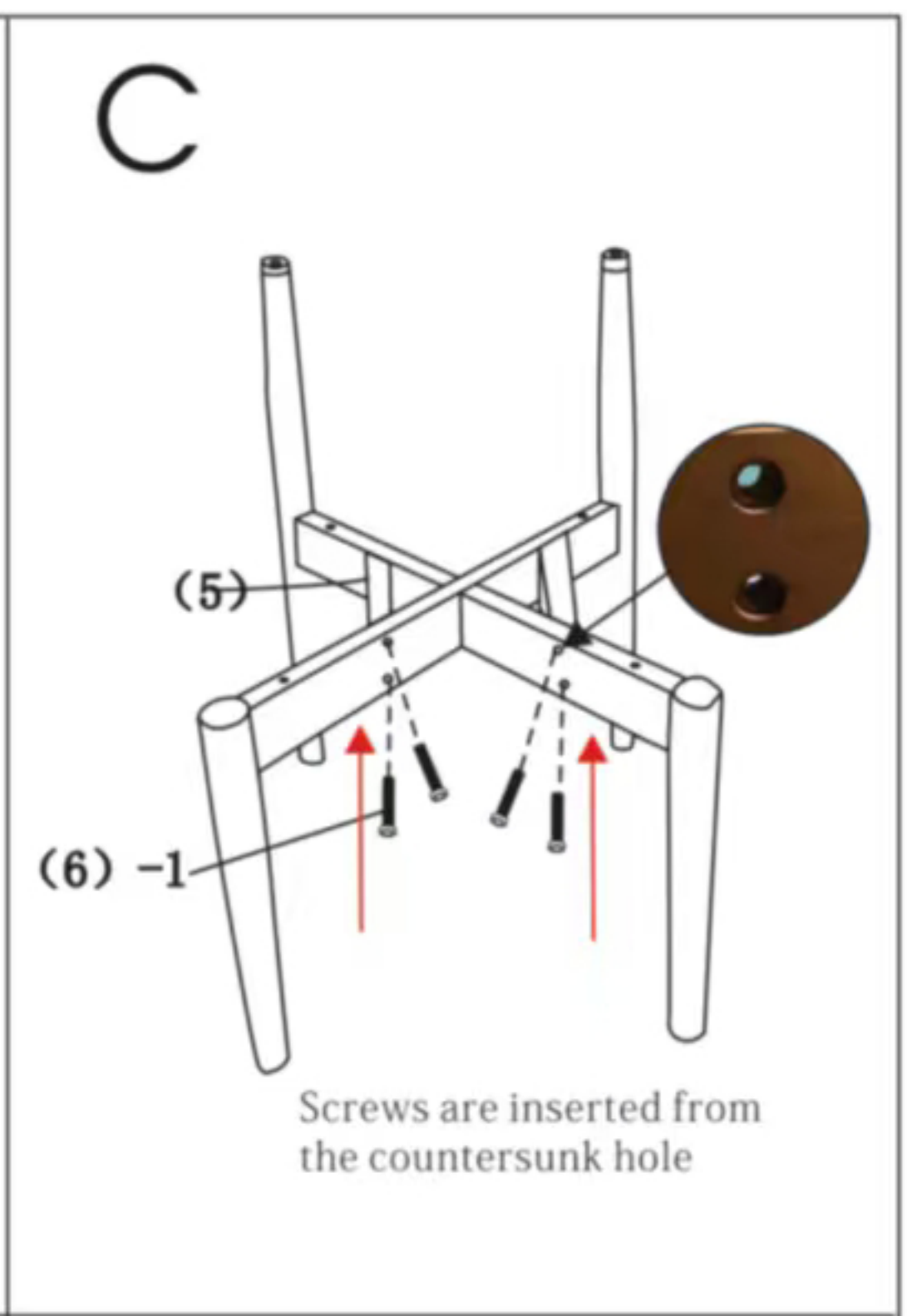
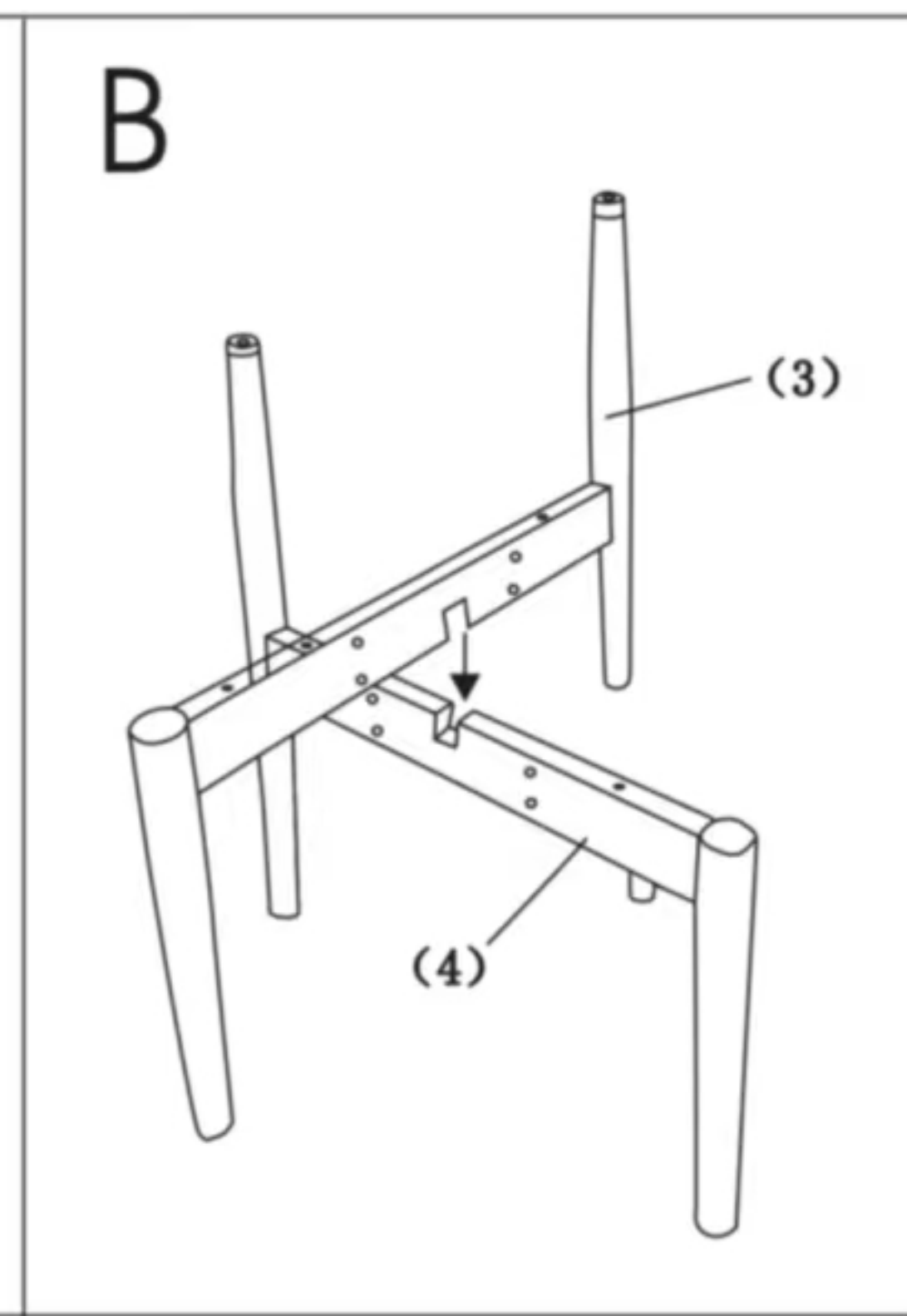
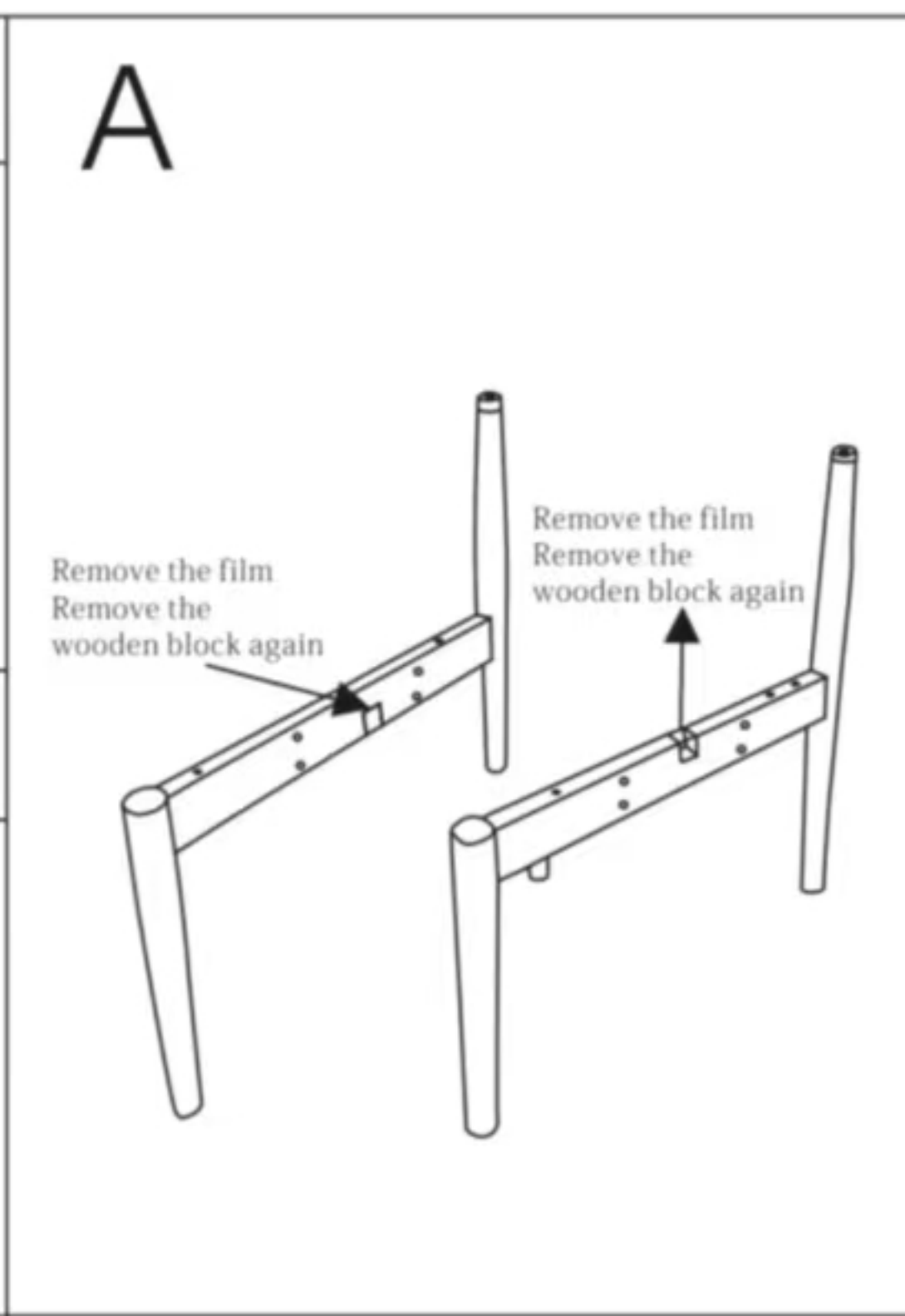
(1) SEAT	(2) BACK	(3) Seat Frame	(4) Seat Frame
 X1	 X1	 X1	 X1
(5) Side plate	<p>Tips: first connect the middle hole of the backrest and the seat, don't screw the bolts too tightly, tighten all bolts together until all holes are aligned</p>		
 X2			



- (6)
- | | | | |
|----|---|-----------------|----|
| 1. |  | (M6x30) (white) | X8 |
| 2. |  | (M6x45) | X4 |
| 3. |  | (M6x25) (black) | X2 |
| 4. |  | | X4 |
| 5. |  | | X2 |
| 6. |  | M5 | X1 |
| 7. |  | M4 | X1 |

