

ASSEMBLY AND INSTALLATION INSTRUCTIONS

WARNING: TO AVOID RISK OF ELECTRICAL SHOCK, BE SURE TO SHUT OFF POWER WHILE INSTALLING OR SERVICING THIS FIXTURE.

NOTES:

1. Before installing, consult local electrical codes for wiring and grounding requirements.
2. Read and save these instructions.
3. Always switch off the electricity supply and allow to cool for 10 minutes before changing the light bulbs.

WALL SCNCE

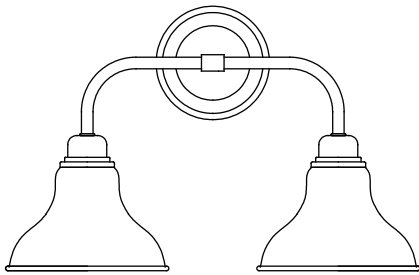

BD017-2-BK

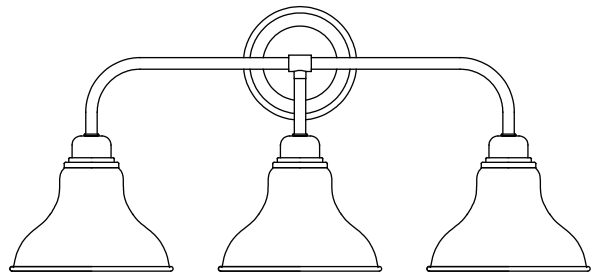

BD017-3-BK

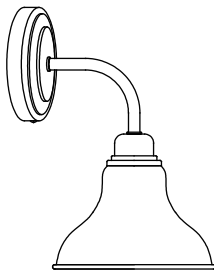

BD017-1-BK

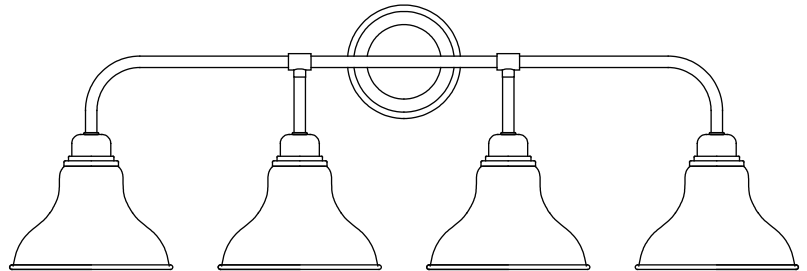

BD017-4-BK

TOOLS REQUIRED

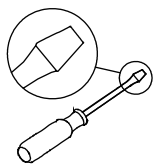

Flathead
Screwdriver



Phillips
Screwdriver

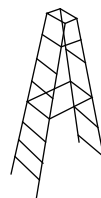

Ladder

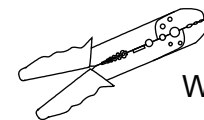

Wire Strippers



Pliers



Electrical
Tape

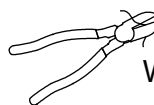

Wire Cutters



Safety Glasses

PREPARATION

Before beginning assembly of product, make sure all parts are present. Compare parts with package contents list and hardware contents list. If any part is missing or damaged, do not attempt to assemble the product. When the lamp is not installed finish, please don't throw away the package, so as not to leave the parts in the package.

PART LIST AND HARDWARE LIST

PIECE	DESCRIPTION
A	Mounting plate
B	Green ground screw
C	Outlet box screw
D	Wire nut

PIECE	DESCRIPTION
E	Mounting screw
F	Fixture body
G	Shade
H	Socket ring+tool

INSTALLATION

1. Attach the mounting plate (A) to the junction box with outlet box screw (C).
2. Attach the supply circuit ground wire (green or bare copper wire) to the the fixture ground wire, black to (black) and white to (white).
3. Attach the fixture body (F) to the mounting plate(A) with mounting screw(E).
4. Attach the socket ring (H) to the shade (G) with the tool(H).
5. Install the 60W MAX "A" bulbs (not included) into socket.

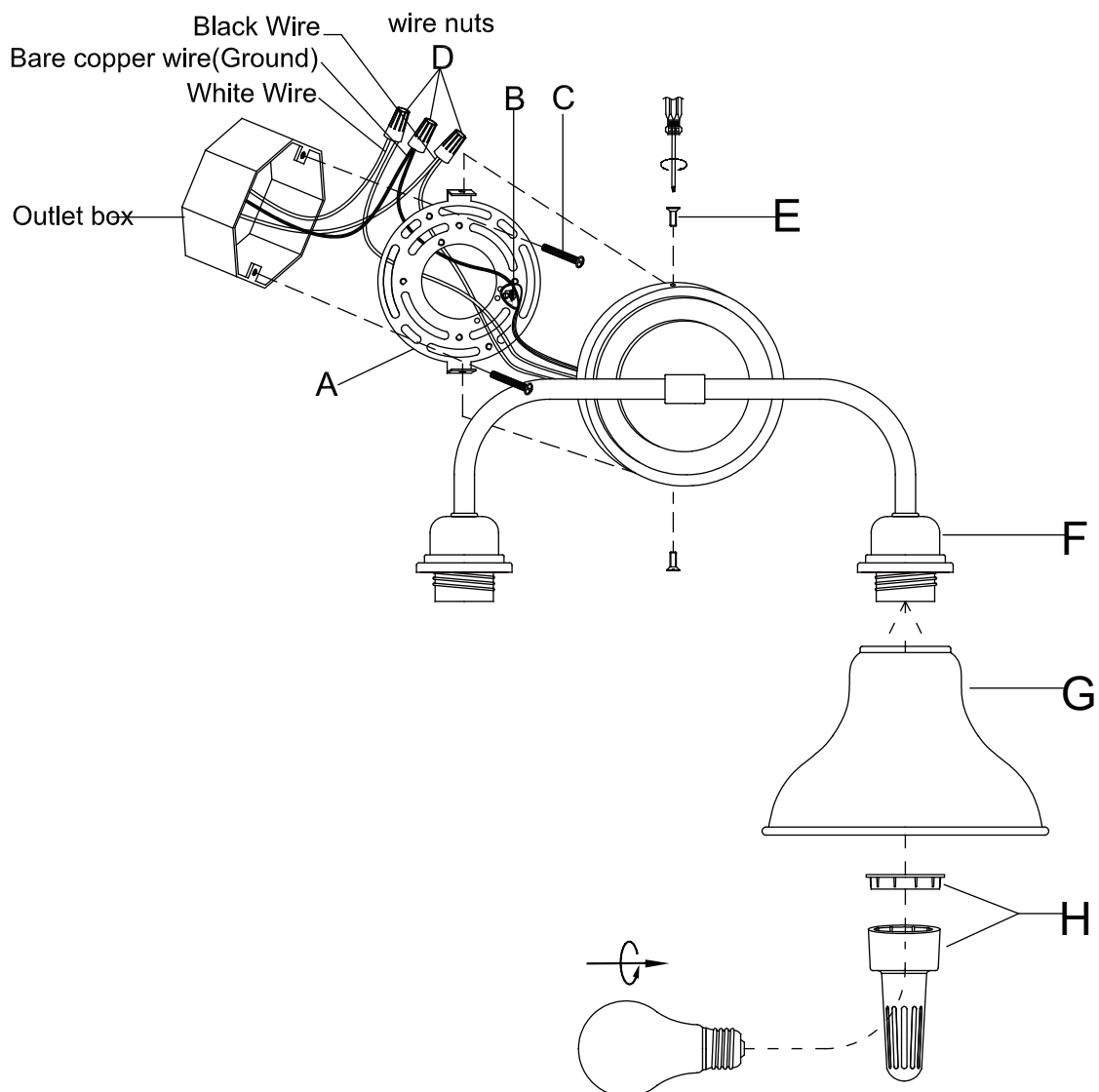

If you have any questions, please contact us, our warmest customer service will assist you within 24 hours.

Pasentel