

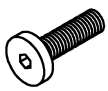

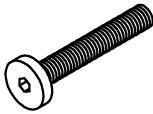

| | | |
|---|--|--|
| <p>A</p>  <p>M6*25 6PCS</p> | <p>B</p>  <p>M6*45 20PCS</p> | <p>C</p>  <p>M8*35 12PCS</p> |
| <p>D</p>  <p>M8*55 3PCS</p> | <p>E</p>  <p>4# 1PCS</p> | |

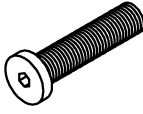
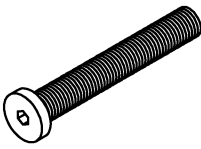

| | | | | |
|---|---|---|--|---|
|  ① 2PCS |  ② 2PCS |  ③ 3PCS |  ④ 2PCS |  ⑤ 2PCS |
|  ⑥ 2PCS |  ⑦ 1PC |  ⑧ 1PC |  ⑨ 1PC |  ⑩ 3PCS |
|  ⑪ 8PCS | | | | |

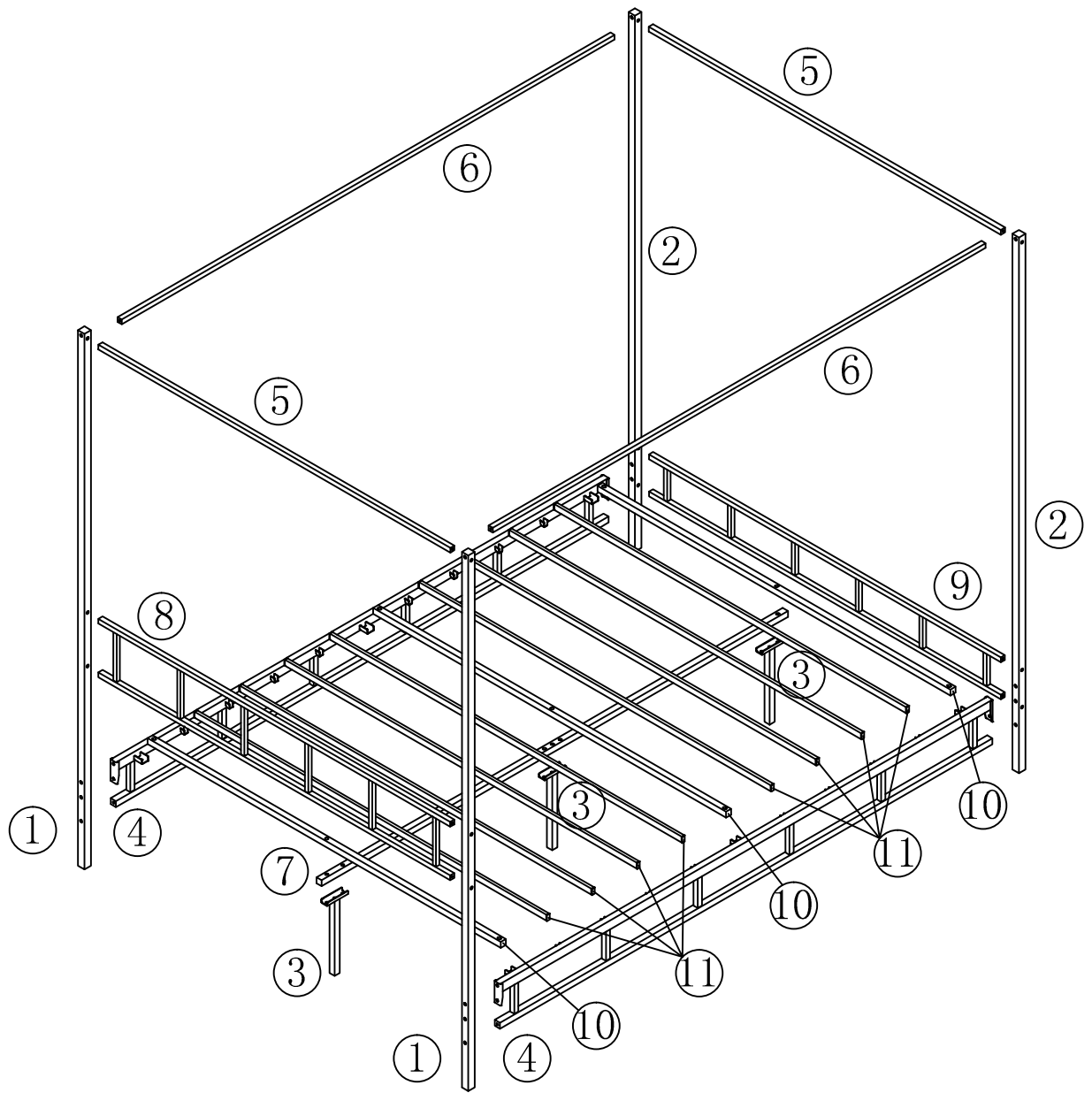
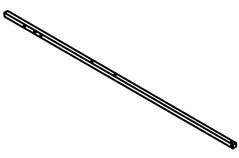
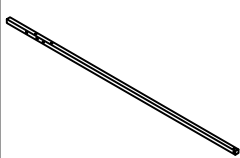
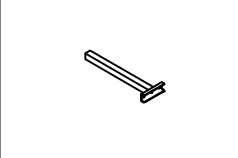
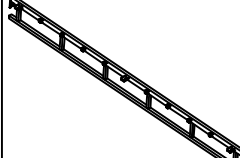
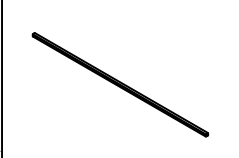
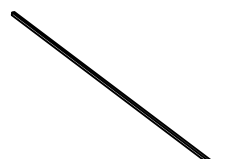
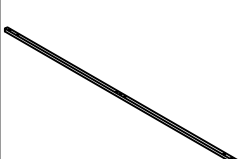
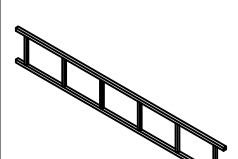
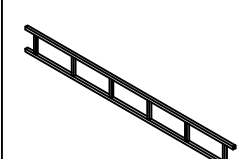
STEP 2

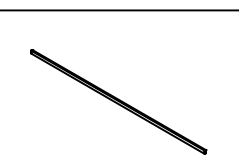
A

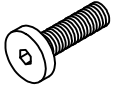

M6*25

6PCS

F



4#

1PC

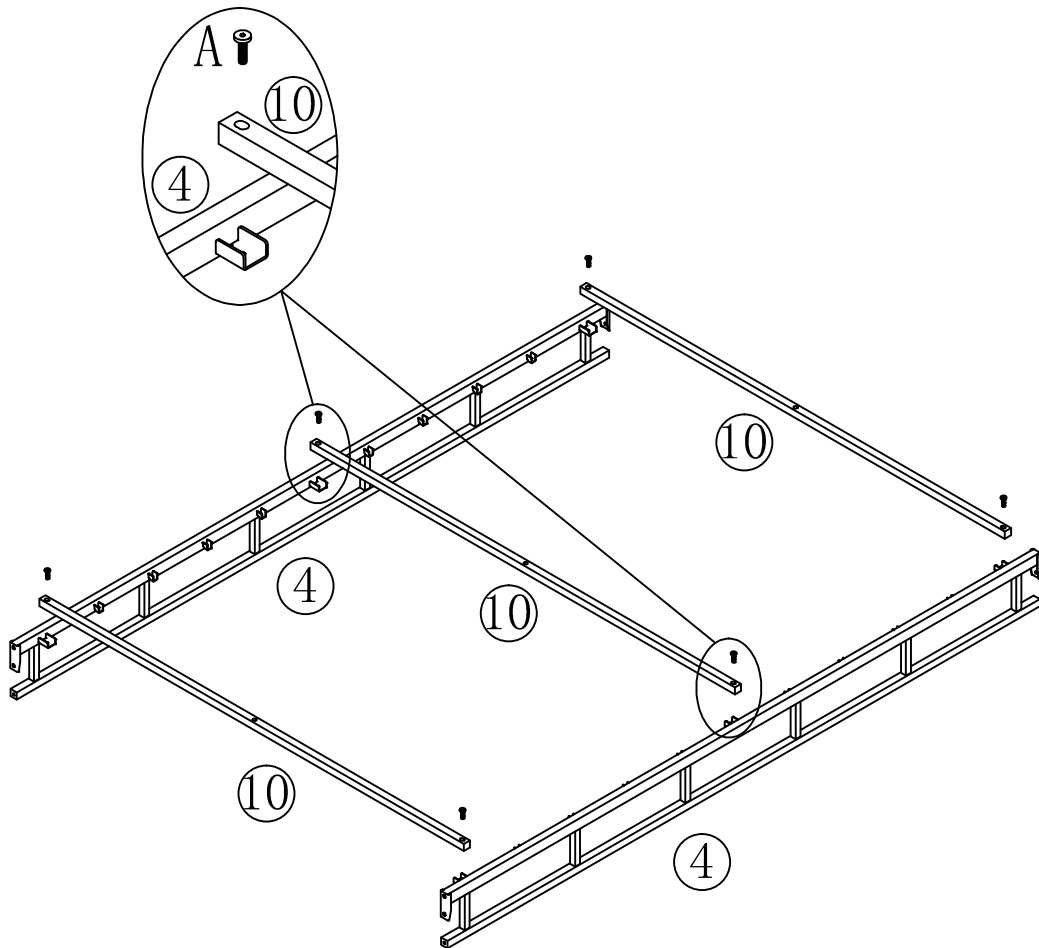

STEP 3

C

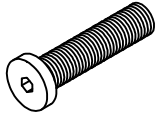

M8*35

4PCS

D

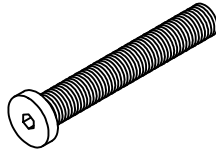

M8*55

3PCS

F



4#

1PC

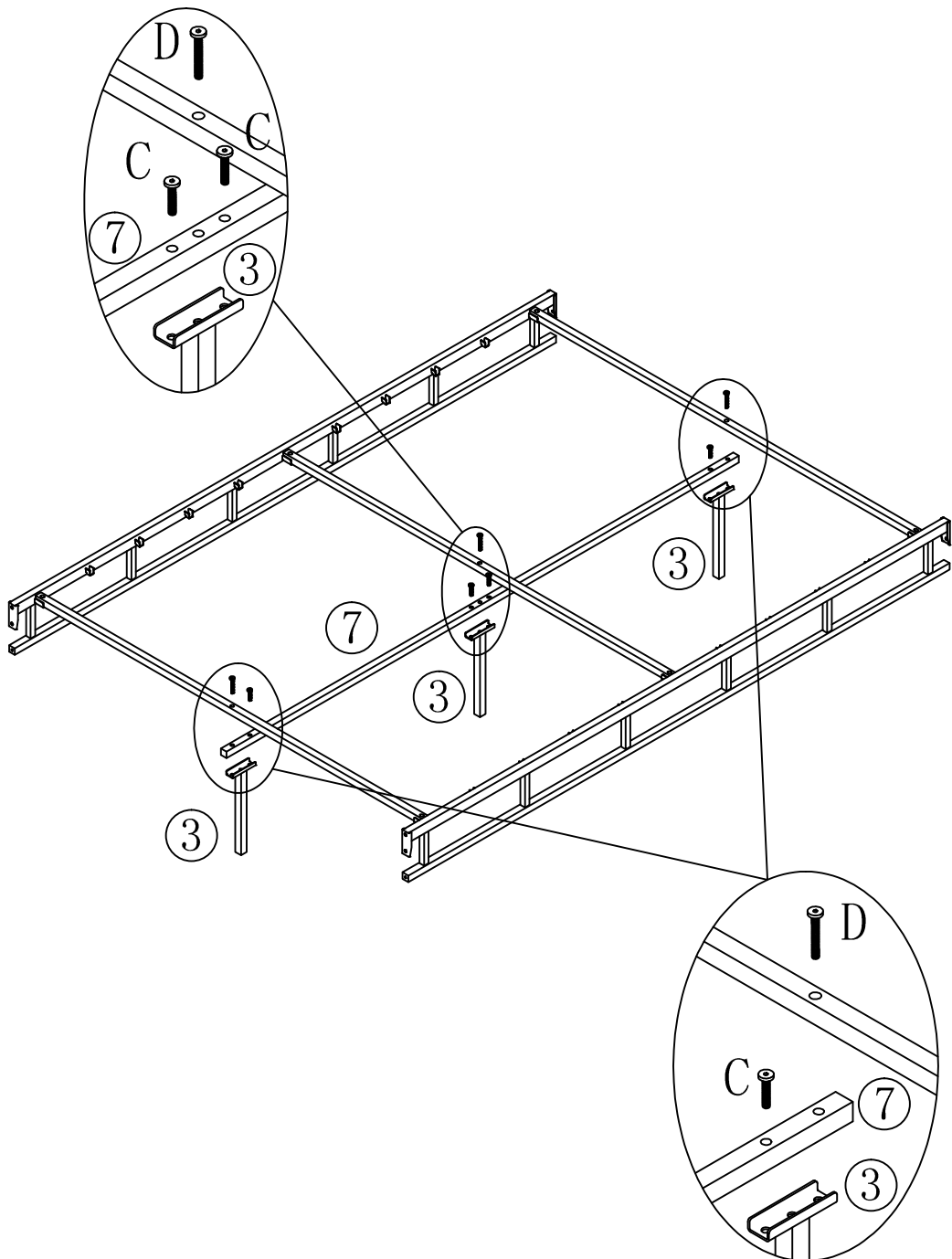

STEP 5

