

Assembly Manual

Dining Chair

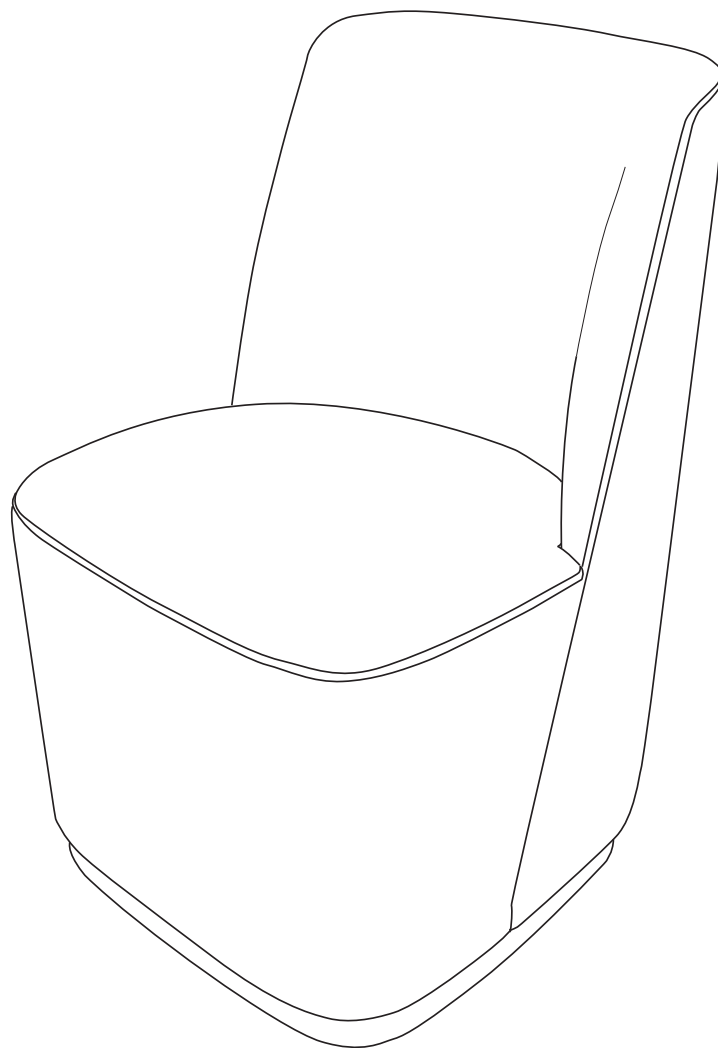

▲ CAUTION

THIS ASSEMBLY MANUAL CONTAINS IMPORTANT SAFETY INFORMATION.

PLEASE READ AND KEEP FOR FUTURE REFERENCE.

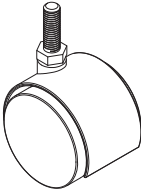
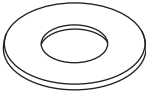
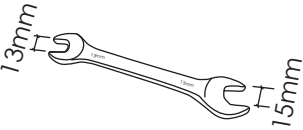
<p>A X 1</p>  <p>Chair</p>	<p>B X 4</p>  <p>Caster</p>	<p>H1 X 4</p>  <p>Flat Washer (φ8)</p>
<p>T1 X 1</p>  <p>Wrench (13-15mm)</p>		

Before you begin:

1. Check if you have received all parts using the diagram on this page. Do not start the assembly process until all parts are present. If you have not received all parts or received wrong or damaged ones, please contact our customer service and we will get back to you.
2. Do not discard any of the packaging until you are certain that you have all the necessary parts for the assembly.
3. Do NOT use power tools for assembly.

- 1 Attach Casters (B) and Flat Washers (H1) to the base of the Chair (A), using Wrench (T1) to fully tighten in clockwise direction.

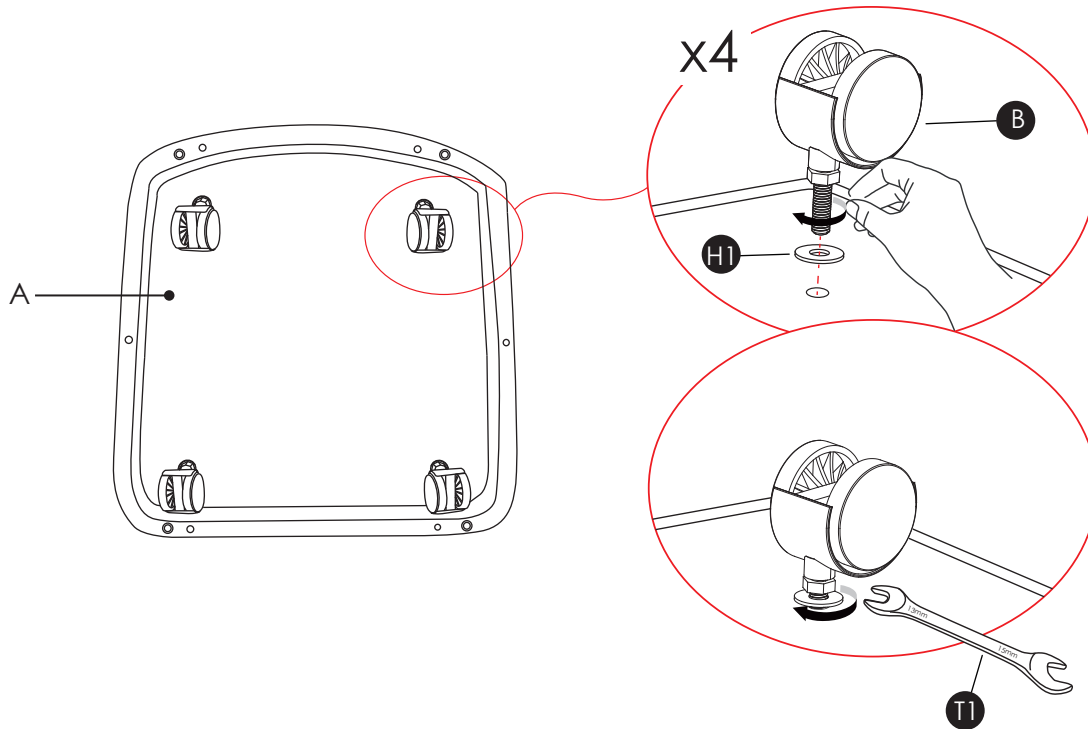

- 2 Assembly complete. Enjoy.

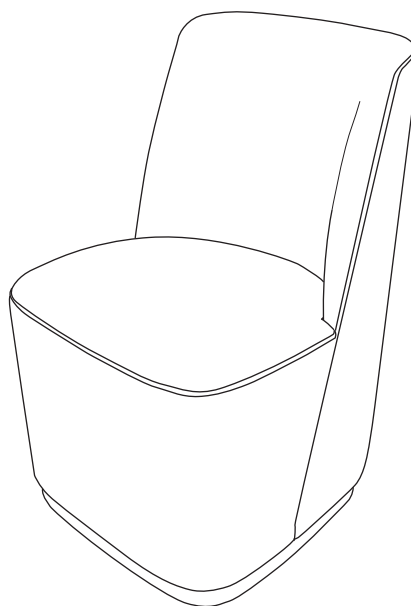

PRODUCT WARRANTY

- 1-year limited on cover against splitting, peeling, and/or tearing.
- 1-year limited on internal and external frame structure.
- 1-year limited on cushioning material, seat springs and mechanism.

CARE & MAINTENANCE

Water Based Cleaner 'W': Spot clean using the foam only from a water-based cleaning agent such as a mild detergent or non-solvent upholstery shampoo product. Apply foam with a soft in circular motion.

Vaccum when dry.

Do not place furniture in direct sunlight and keep furniture at least 60 cm / 2 feet from heat sources to avoid fading.

If at any step you need a helping hand, we're always here for you. You can email us, or hop into a live chat on our website - whatever method is convenient for you.