

Corner Bar Cabinet

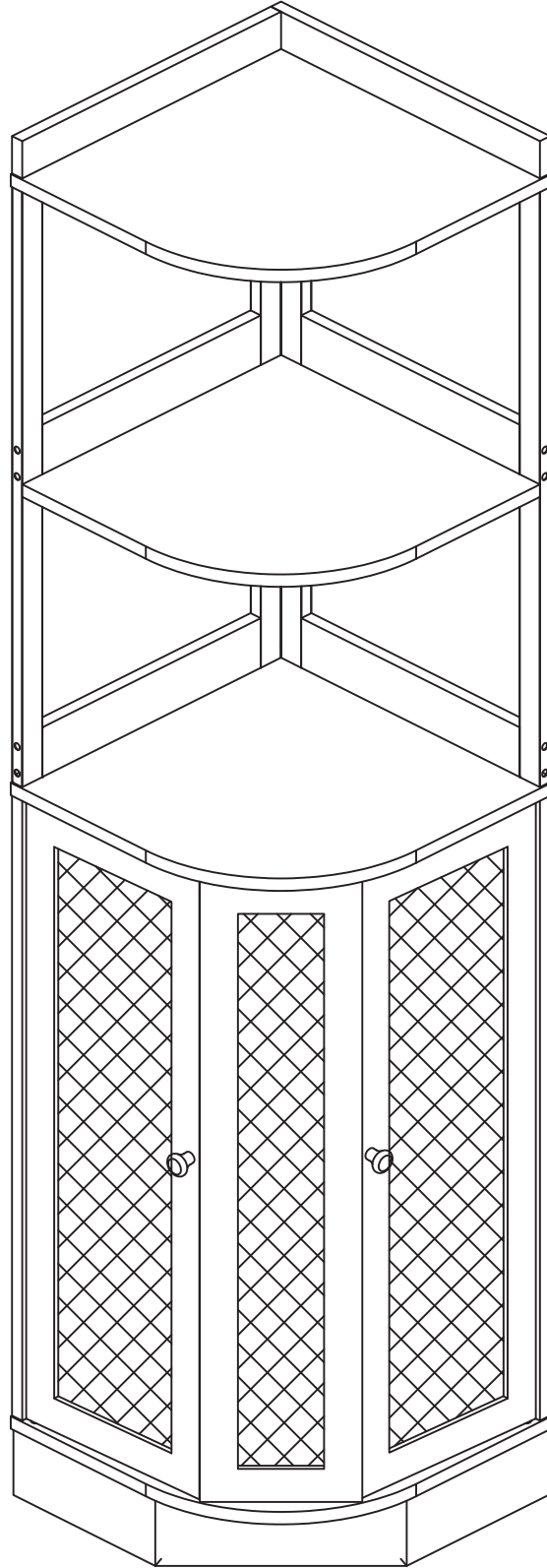

If you have any questions or need assistance, feel free to reach out to our after-sales team.

Before You Start

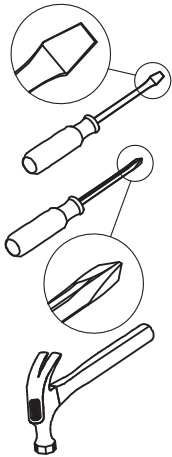

- Read through each step carefully and follow the proper order
- Separate and count all your parts and hardware
- Give yourself enough room for the assembly process
- Have the following tools: Flat Head Screwdriver, #2 Phillips Head Screwdriver and Hammer
- Caution: If using a power drill or power screwdriver for screwing, please be aware of to slow down and stop when screw is tight. Failure to do so may result in stripping the screw.

Helpful Hints

PEOPLE NEEDED FOR ASSEMBLY: 1-2

- Open your item in the area you plan to keep it to avoid excessive heavy lifting
- Identify, sort and count the parts before attempting assembly.
- Compression dowels are lightly tapped in with a hammer.
- Slides are labeled with an **R** (right) and **L** (left) for proper placement.
- Make sure to always face the point on the top of the Cam Lock towards the outer edge.
- Use all the nails provided for the back panel and spread them out equally.
- Back panel must be used to make sure your unit is sturdy.
- Do NOT use harsh chemicals or abrasive cleaners on this item.
- Never push, pull, or drag your furniture.



REMARK:



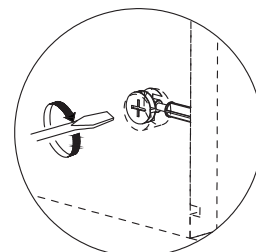
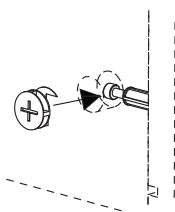
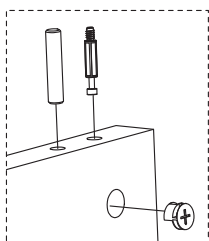



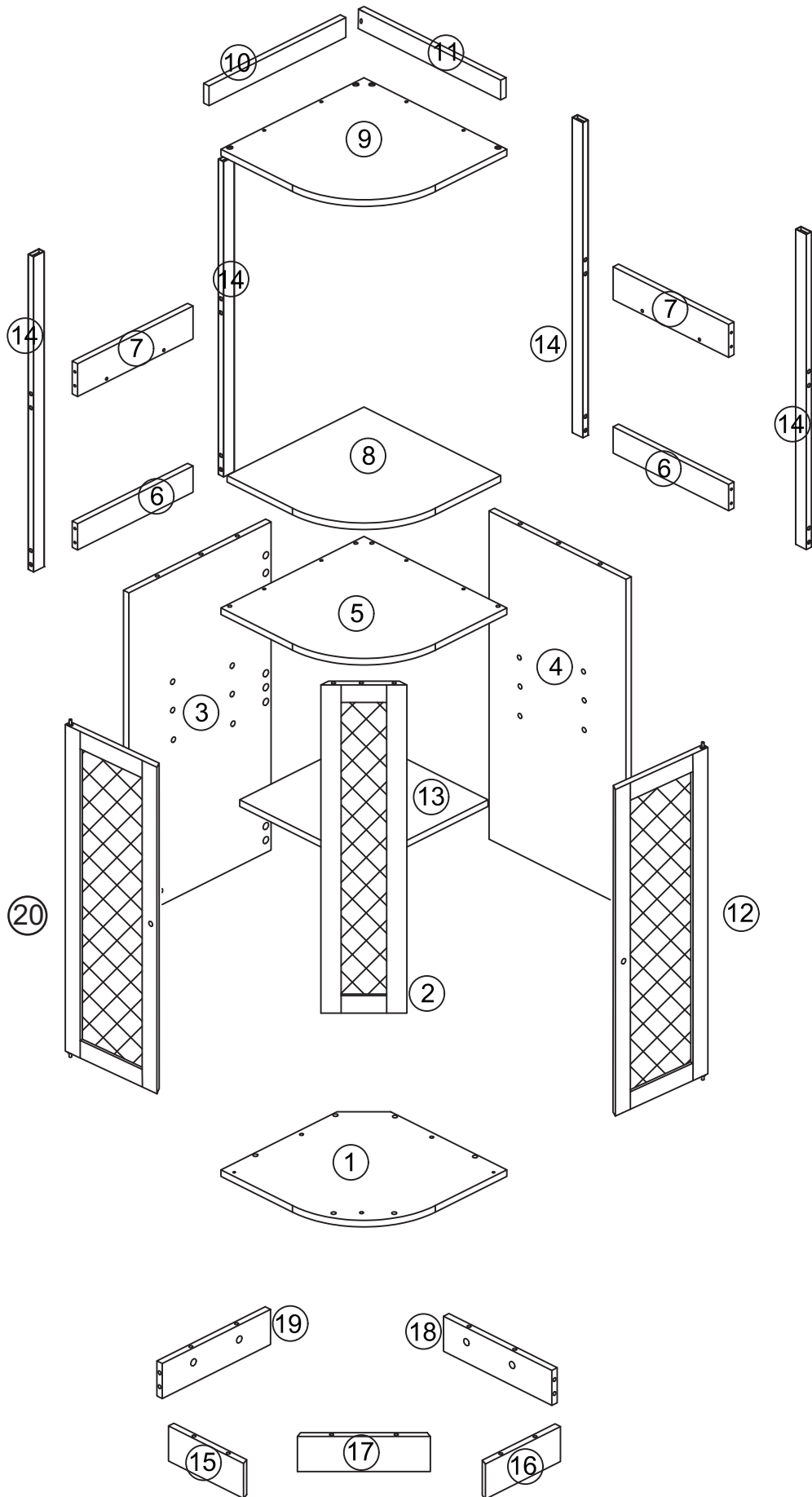



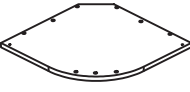
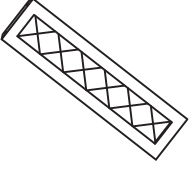
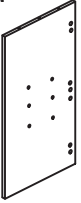
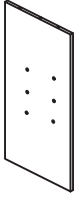





MIN FIX POSITION















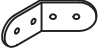

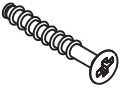
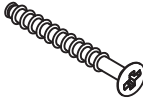
Exploded Drawing

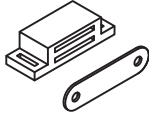

Parts

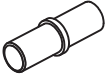
Board  ① x1	Middle door  ② x1	Board  ③ x1	Board  ④ x1
Board  ⑤ x1	Wood lath  ⑥ x2	Wood lath  ⑦ x2	Board  ⑧ x1
Board  ⑨ x1	Wood lath  ⑩ x1	Wood lath  ⑪ x1	Right door  ⑫ x1
Board  ⑬ x1	Metal rack  ⑭ x4	Wood base lath  ⑮ x1	Wood base lath  ⑯ x1
Wood base lath  ⑰ x1	Wood base lath  ⑱ x1	Wood base lath  ⑲ x1	Left door  ⑳ x1

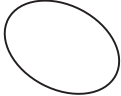
Accessory Parts List

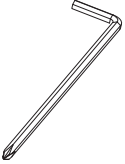
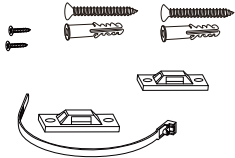
<p>Bolt</p>  <p>Ax25</p>	<p>Cam lock</p>  <p>B x25</p>	<p>Wooden dowel</p>  <p>8*40</p> <p>Cx10</p>	<p>Metal connector</p>  <p>Dx2</p>
<p>Screw</p>  <p>M4*12</p> <p>E x12</p>	<p>Bolt</p>  <p>M5*40</p> <p>F x17</p>	<p>Bolt</p>  <p>M6*50</p> <p>Gx16</p>	<p>Bolt</p>  <p>M6*25</p> <p>Hx8</p>
<p>Door knob screw</p>  <p>I x2</p>	<p>Wine rack</p>  <p>J x2</p>	<p>Magnetic door catch</p>  <p>K x2</p>	<p>Screw</p>  <p>M3*14</p> <p>L x8</p>
<p>Shelf support pin</p>  <p>Mx6</p>	<p>Door knob</p>  <p>Nx2</p>	<p>Hold sticker</p>  <p>O</p>	<p>Door support pin</p>  <p>P x4</p>
<p>Key wrench</p>  <p>S x1</p>	<p>Anti tipping fixing strap</p>  <p>T x2</p>		

Step 1

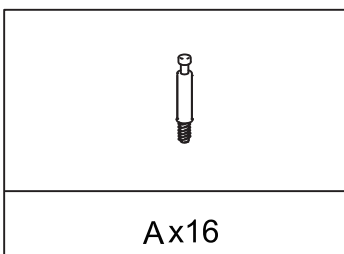
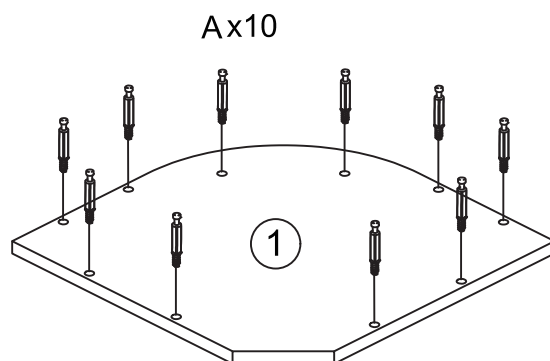
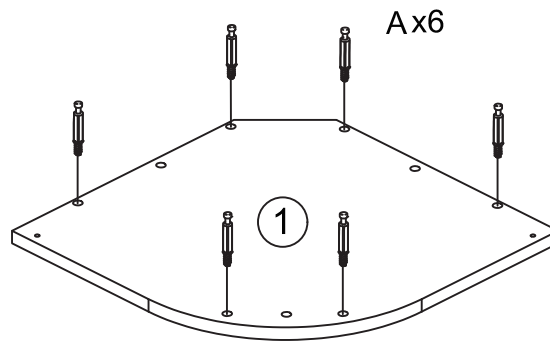
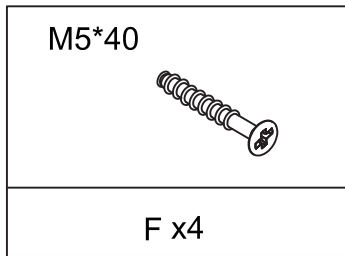
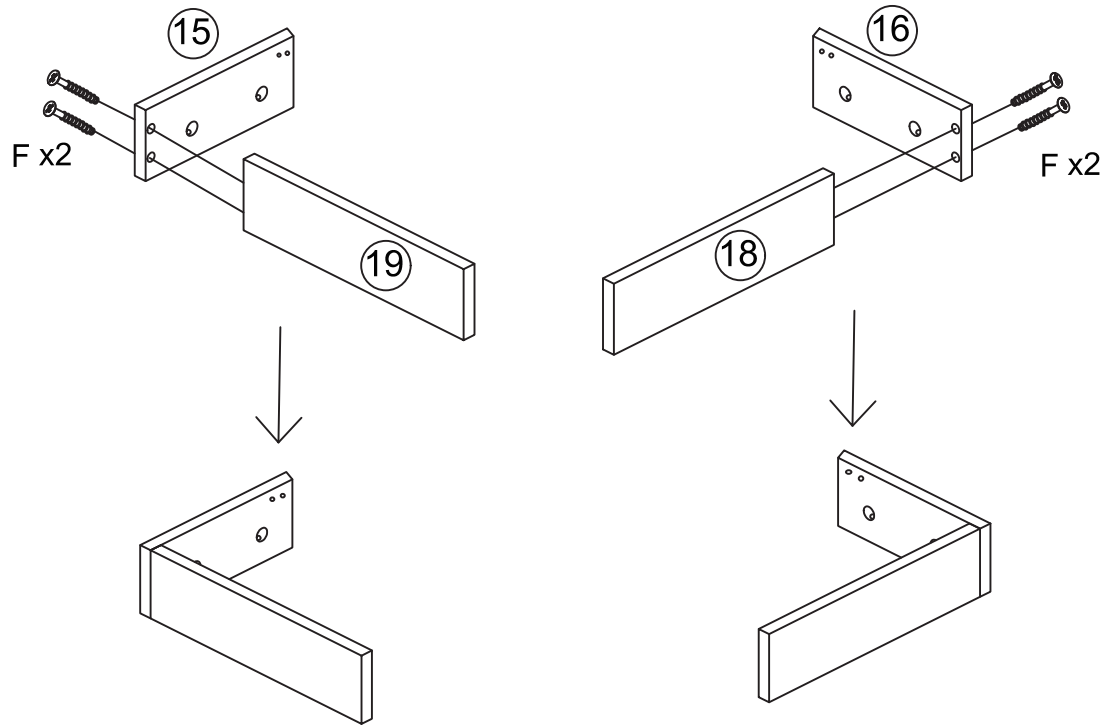

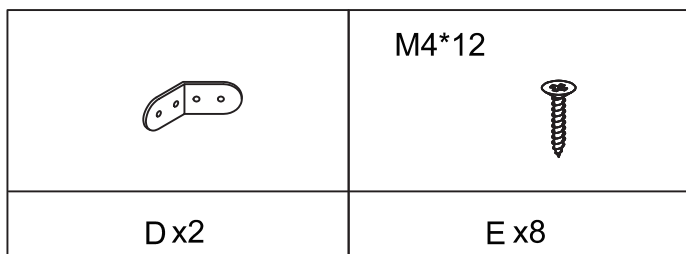
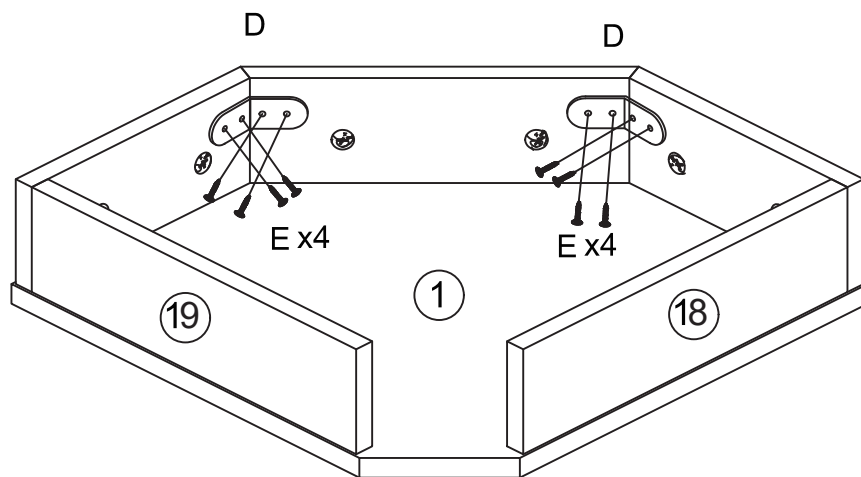
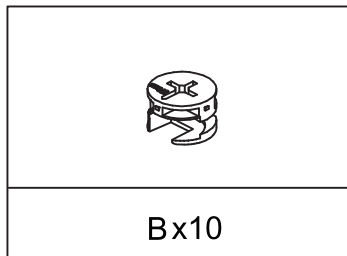
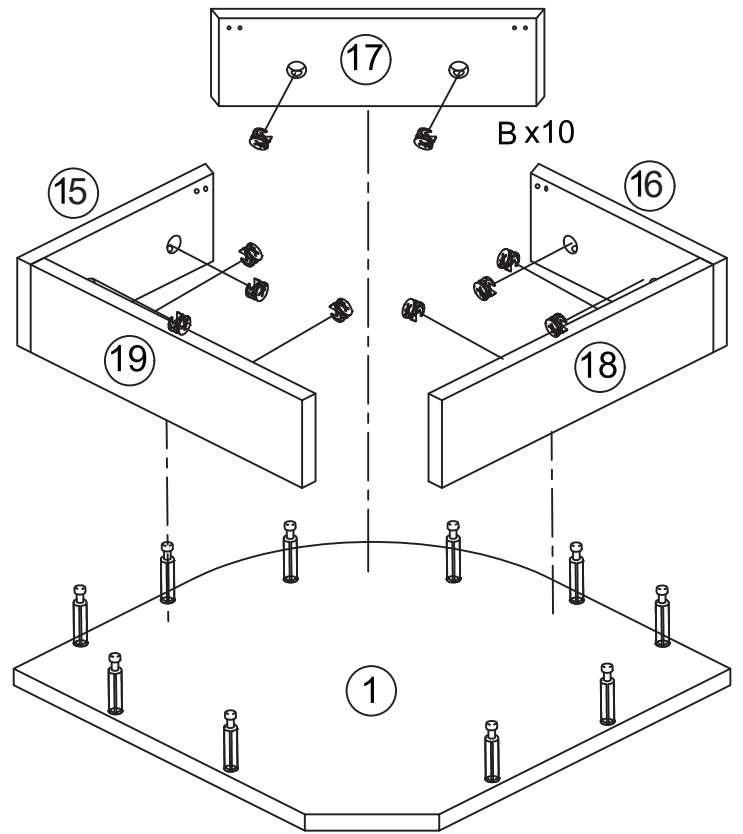

Step 2



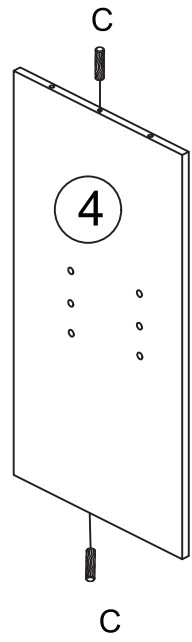
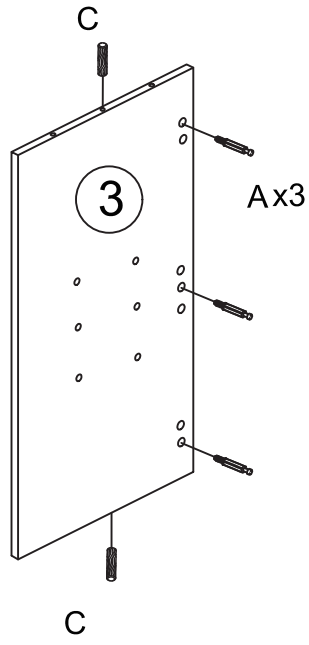
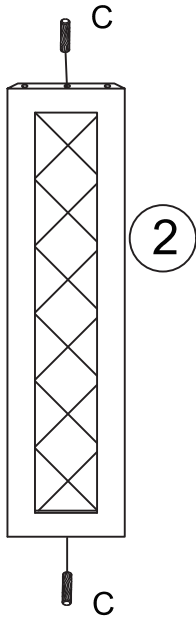

Step 3

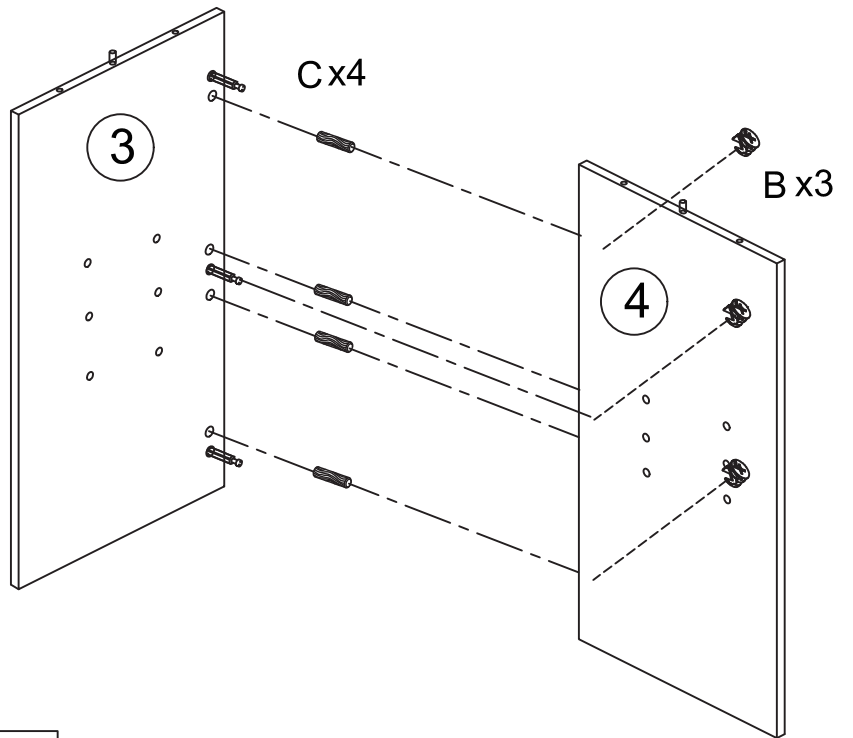

8*40 	
Cx6	Ax3



	8*40 
Bx3	Cx4

Step 4

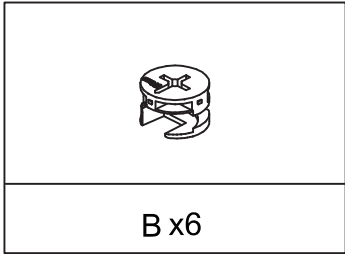
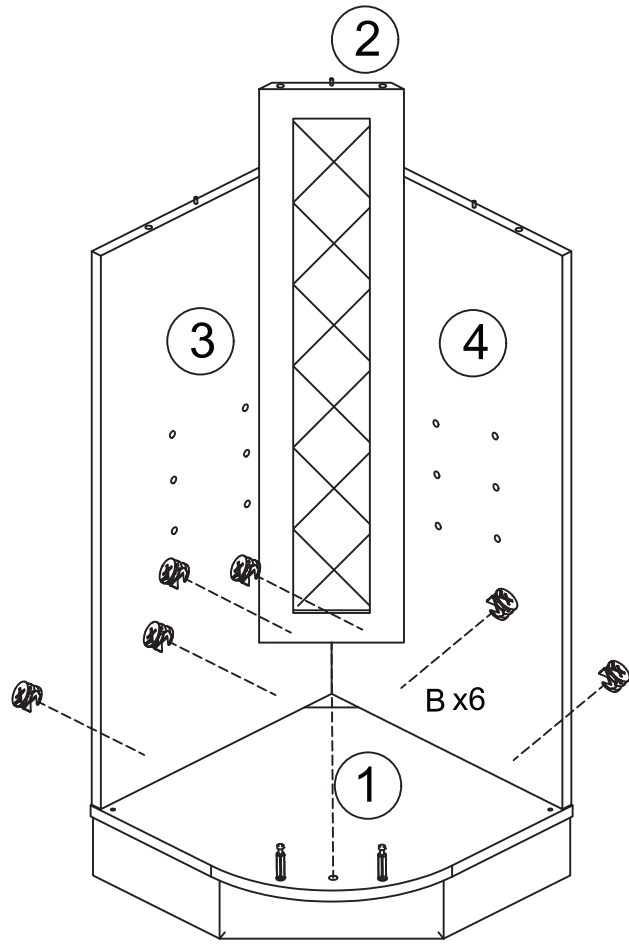

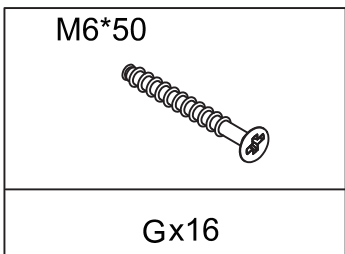
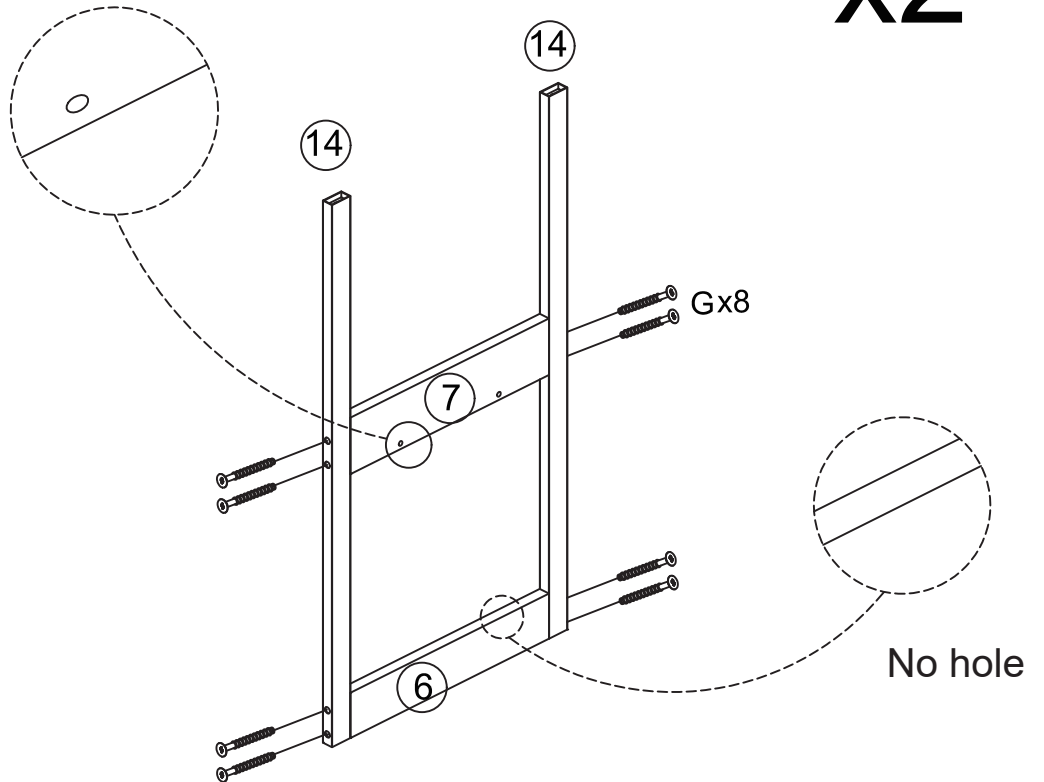

x2

Big holes facing out

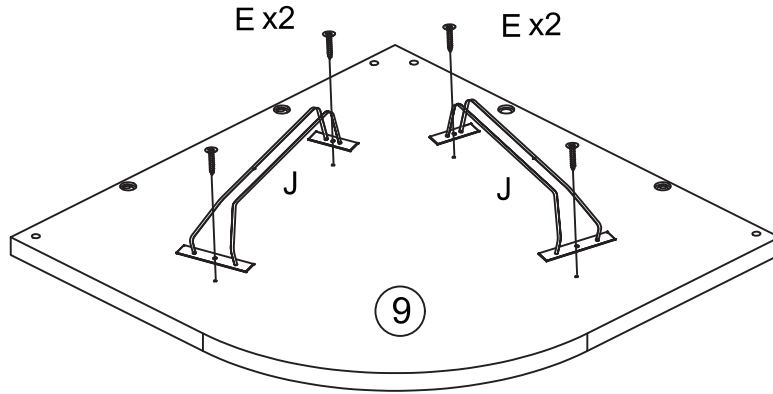

Step 5

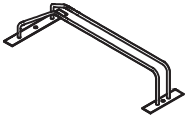

M4*12 	
E x 4	J x 2

REMARK:



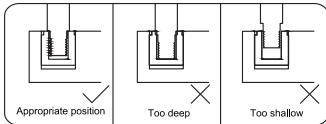

Please do not screw **A** too deep or too shallow.

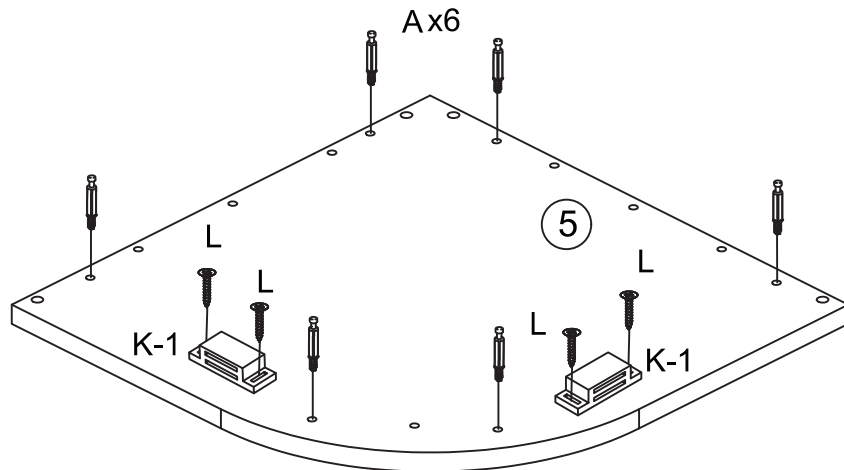

REMARK :

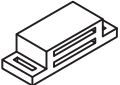
Put a blanket under the board to avoid scratch or damage.



K-1 	K-2 	M3*14 	
K x 2		L x 4	A x 6

Step 6

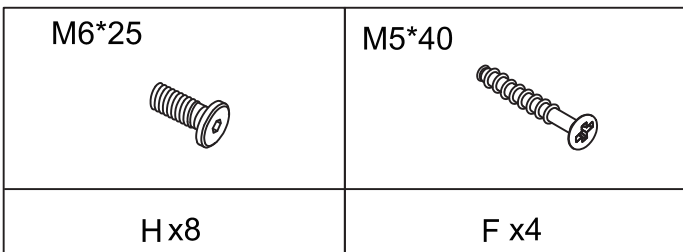
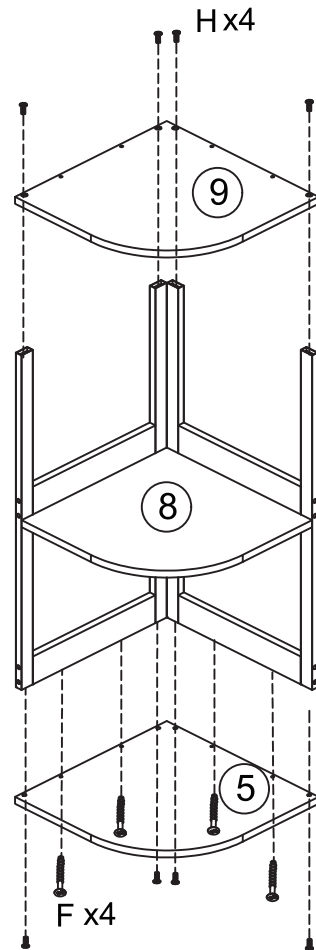
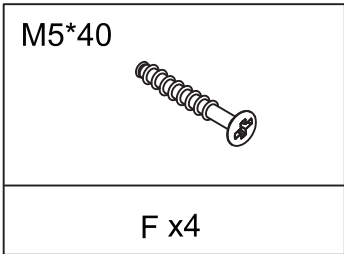
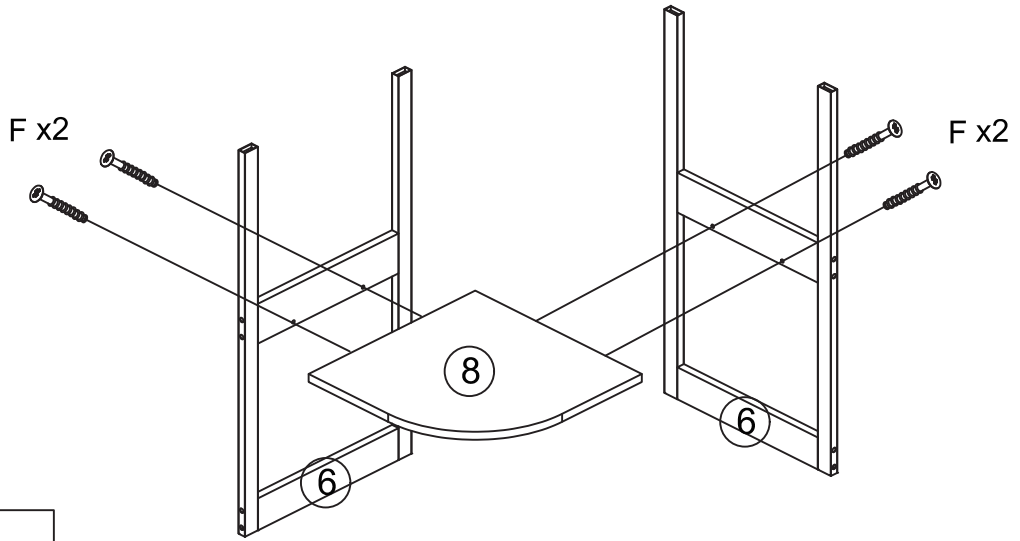

H x4

Step 7

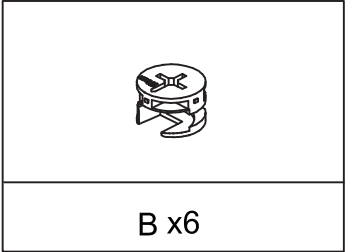
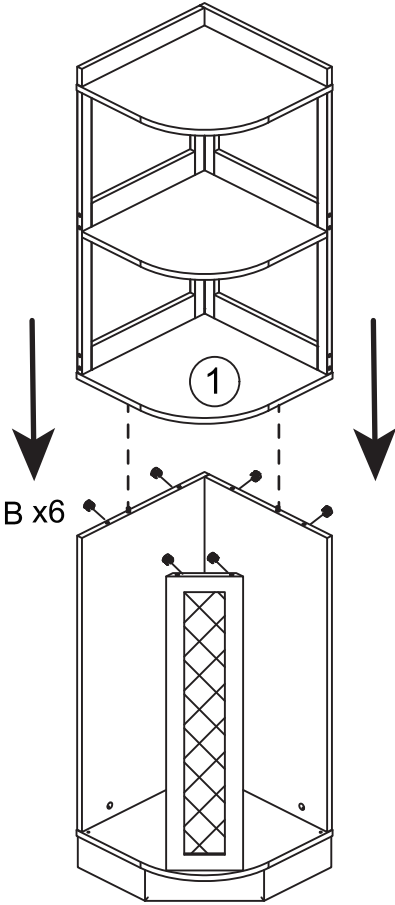
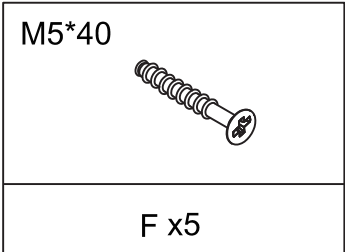
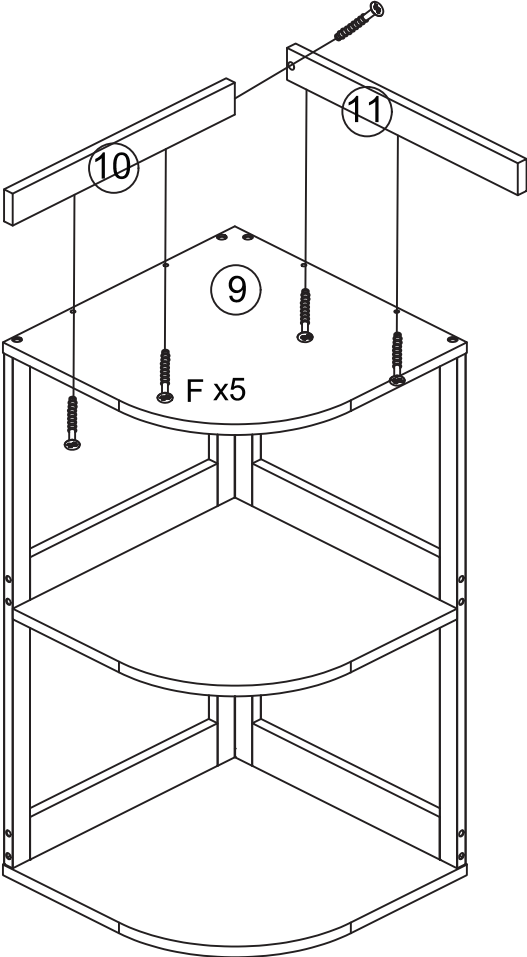

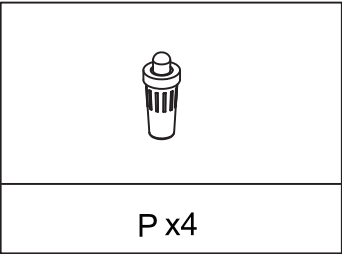
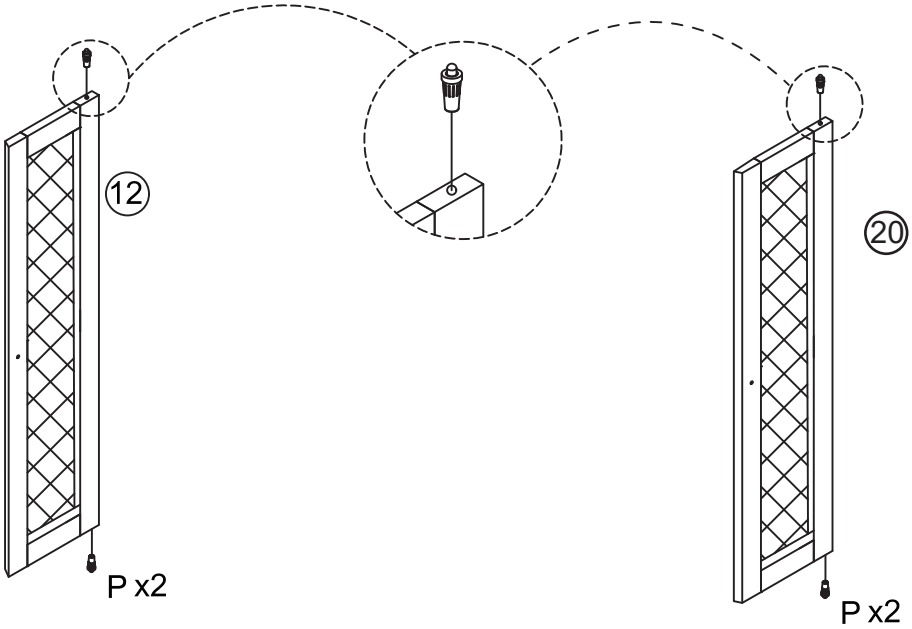
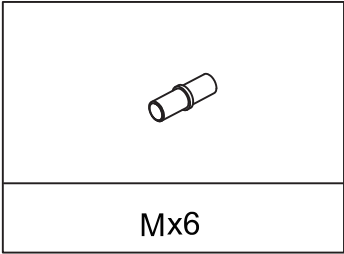
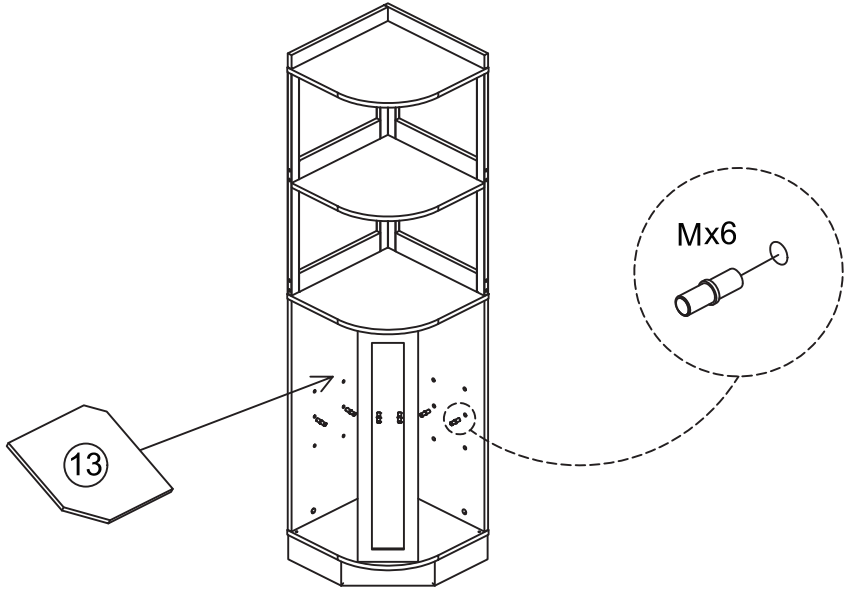

Step 8

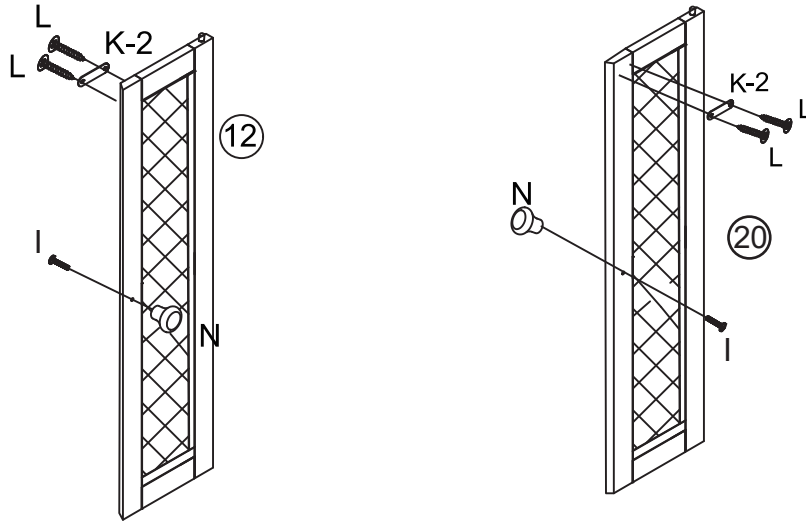

Step 9

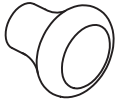
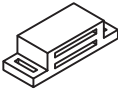

				
I x2	Nx2	K x2		L x4

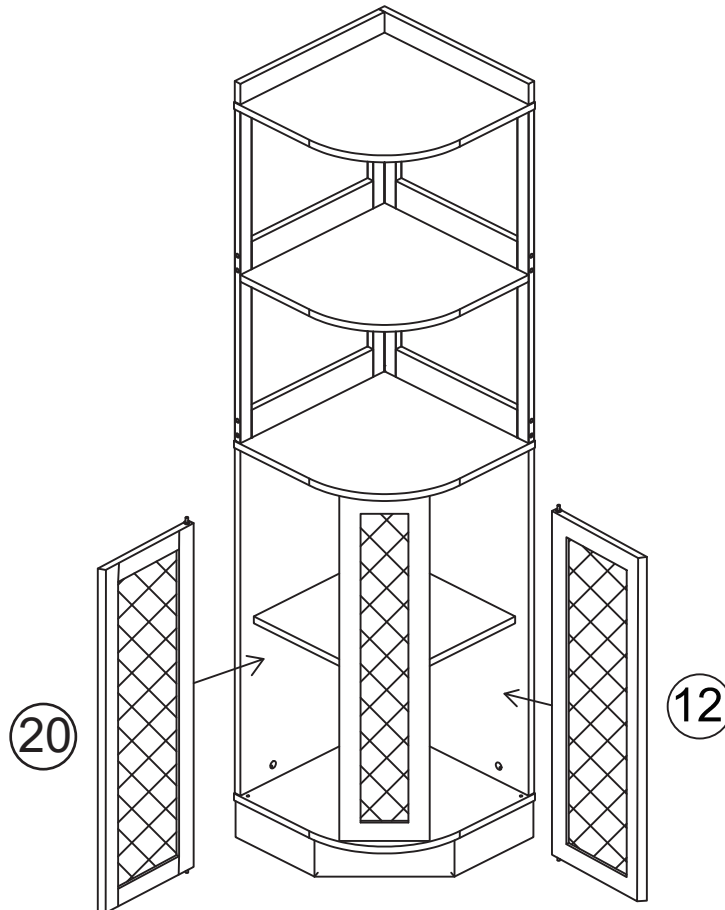

Step 10

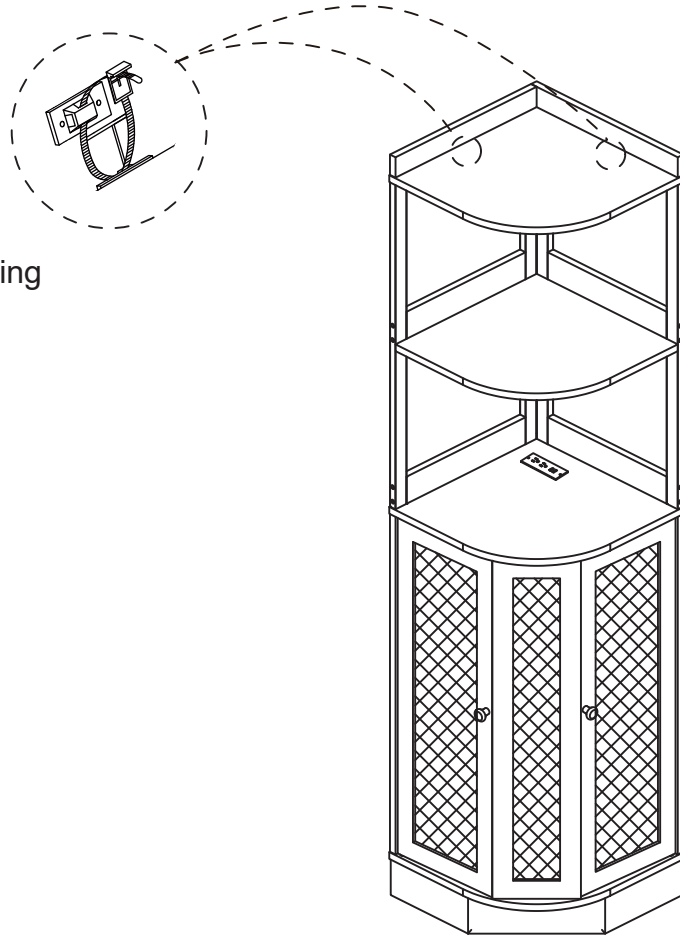

Anti tipping installation schematic:
You can decide to install an anti tipping
fixing strap according your needs.

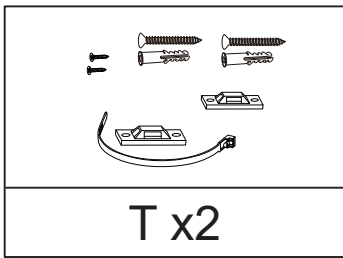

Installation Steps

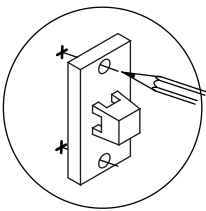

1, Mark the wall

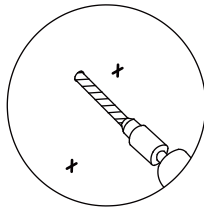

2, Drill holes in the wall

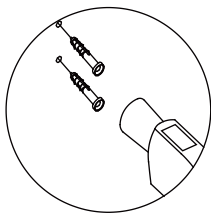

3, Push in the plastic plug

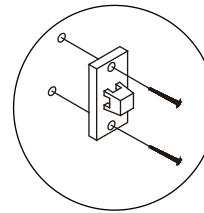

4, Insert long screws into the wall to
fix the clasp

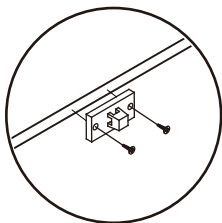

5, Secure the clasp with short screws
at the ⑨ board side

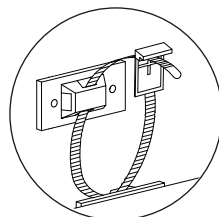

6, Push the plastic tie through the holes
in the two clasps and tighten it.

Tips: The screws that leak outside cabinet can be added O hole sticker or not by yourself.

If you have any questions or need assistance, feel free to reach out to our after-sales team