

INSTALLATION INSTRUCTIONS

20X20 ft Carport

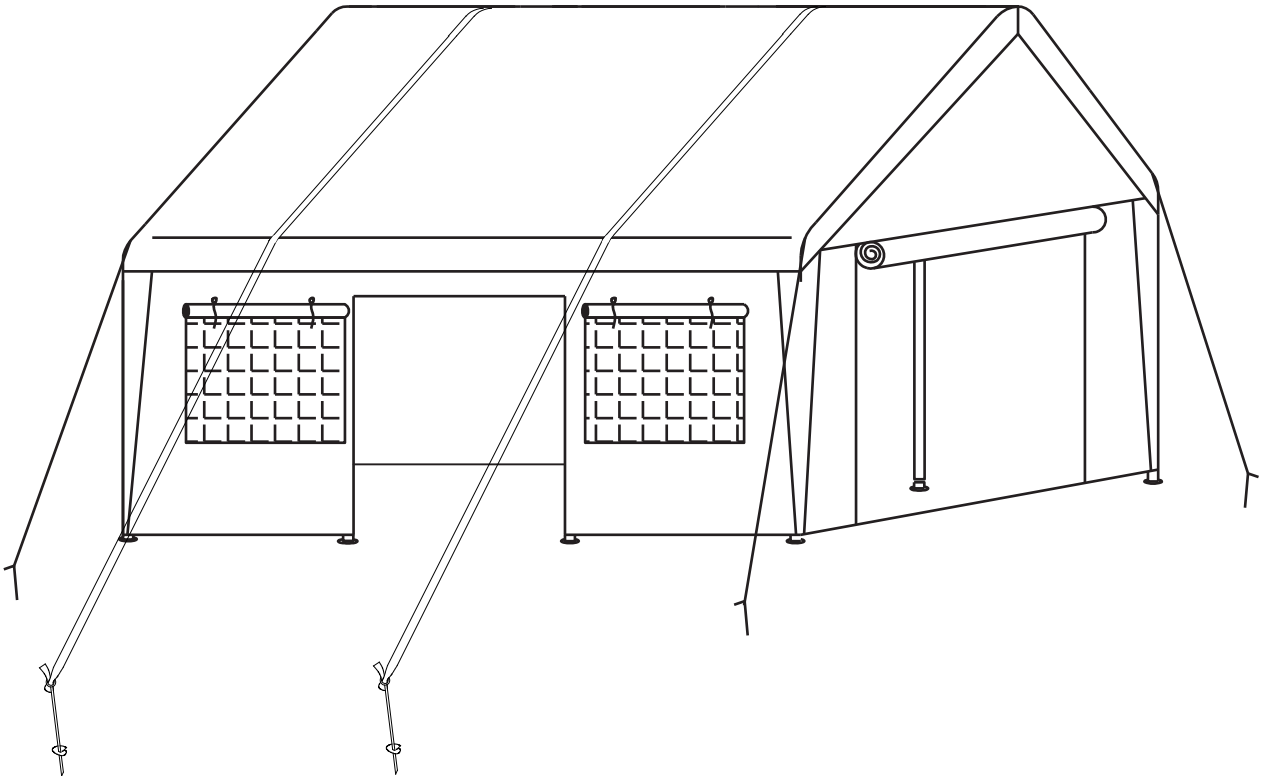

CARPORT USER MANUAL

20 X 20 FT

 VIWATCustomerService@gmail.com

Our team is available 24/7 to help with any product questions. Contact us anytime!

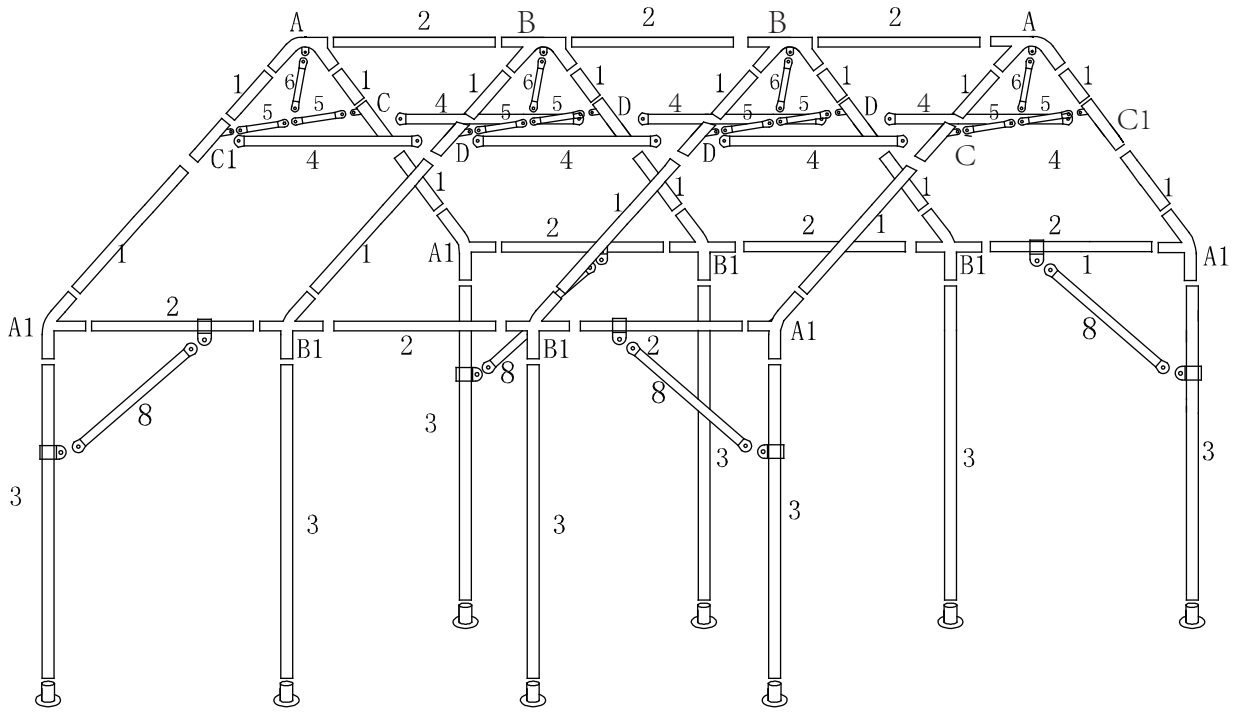

1 x16

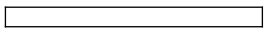

2 x9

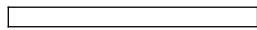

3 x8

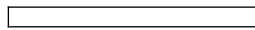

4 x6

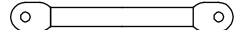

5 x8

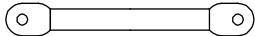

6 x4

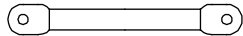

8 x4

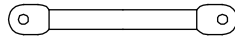

E x2

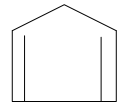

A x2

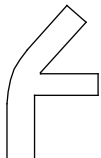

A1 x4



B x2

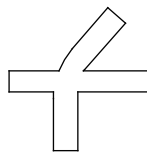

B1 x4

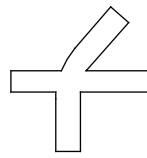

Q x1

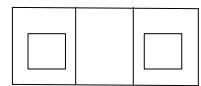

C1 x2

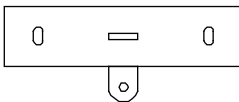

C x2

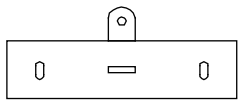

D x4

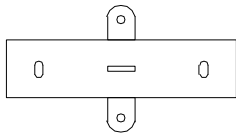

P x1

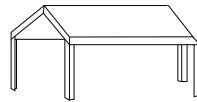

Q1 x1

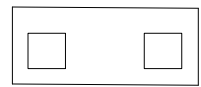

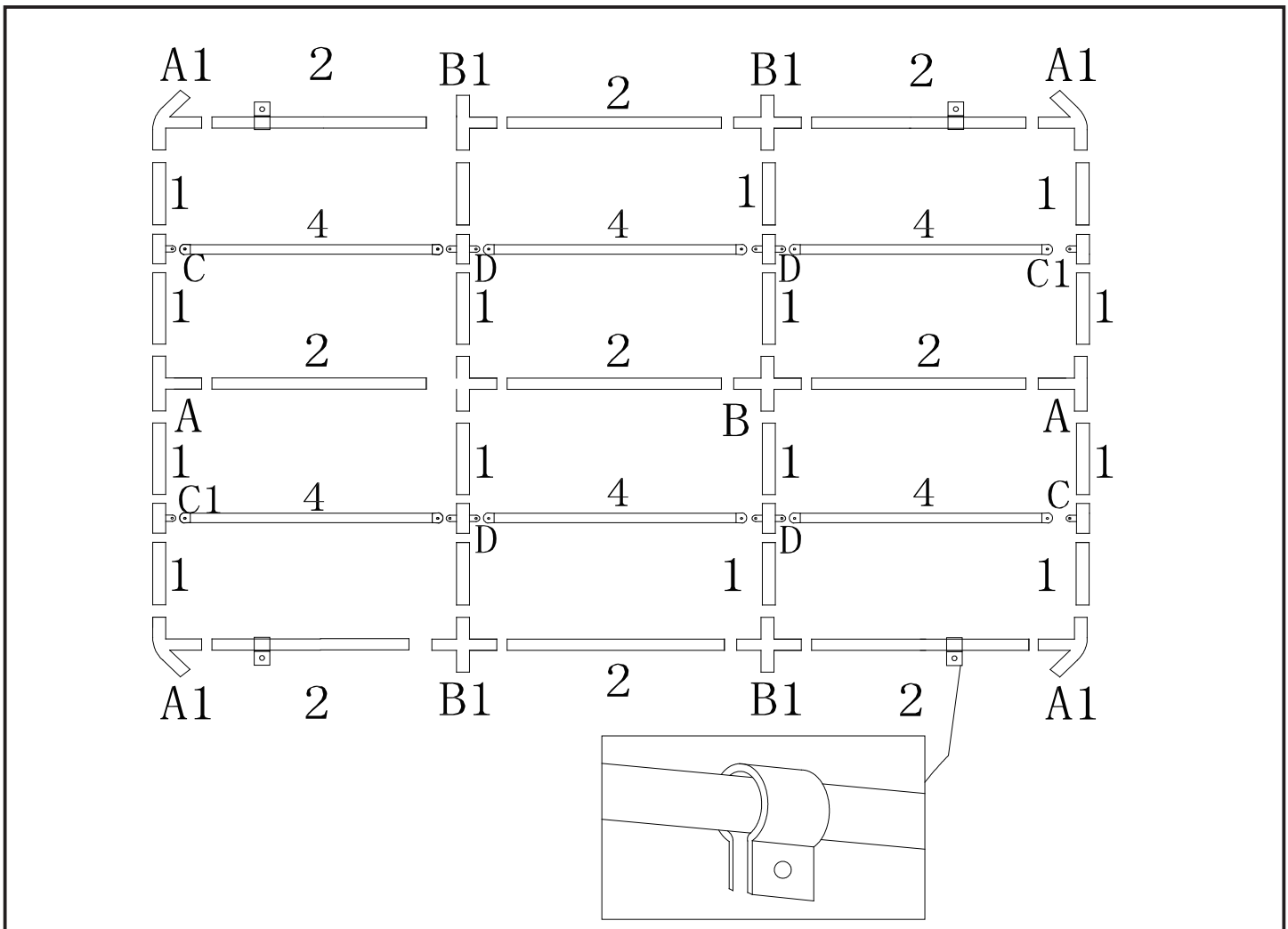
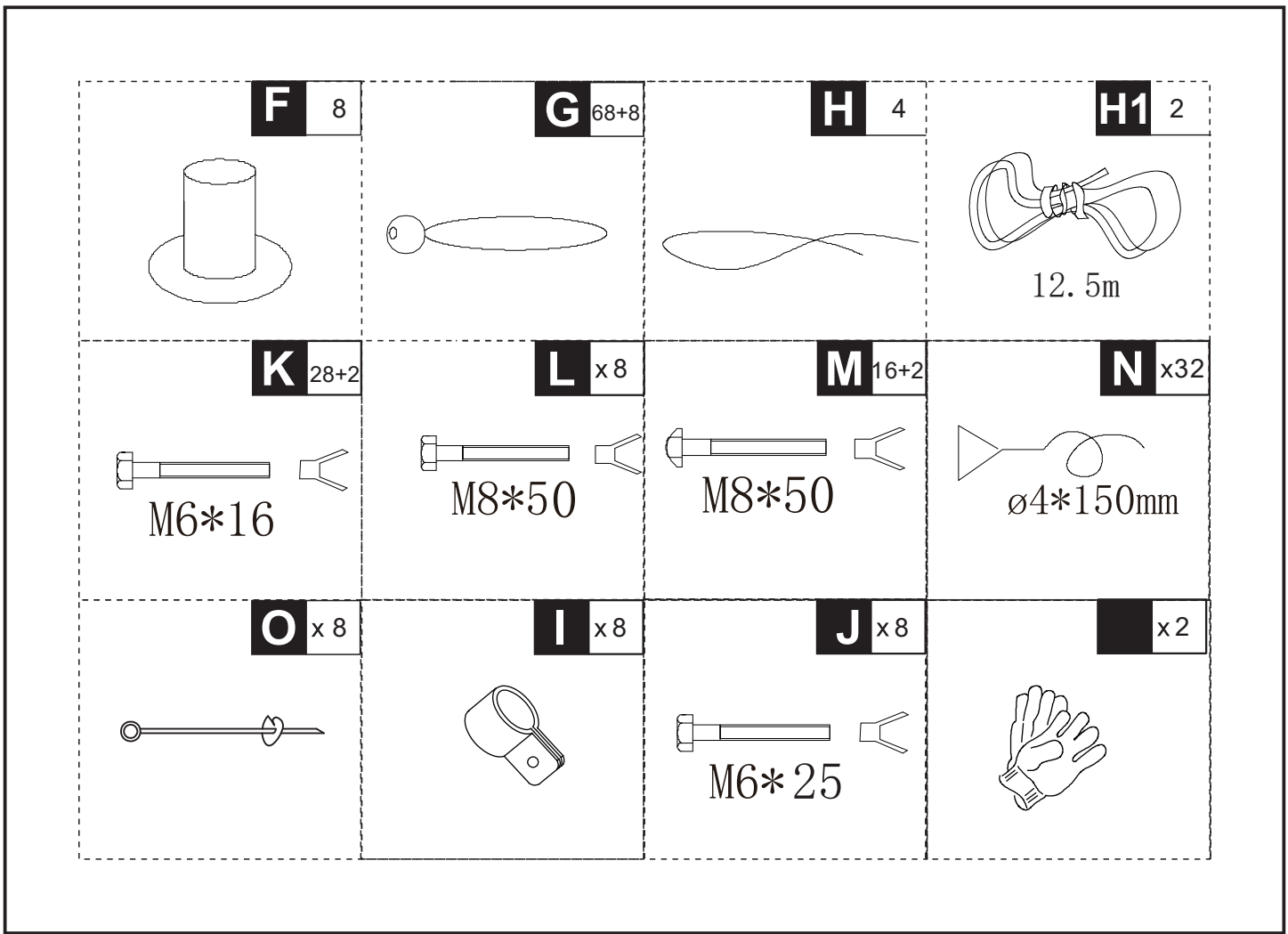

M6*16 x 12

M8*50 x 16

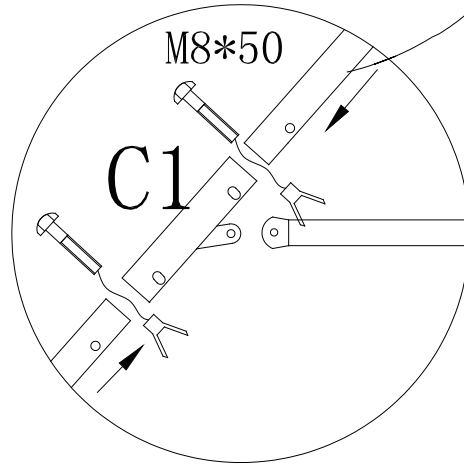
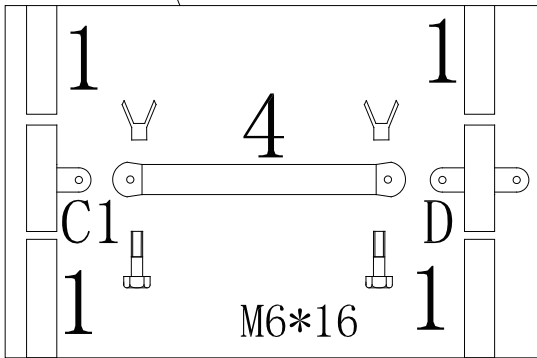
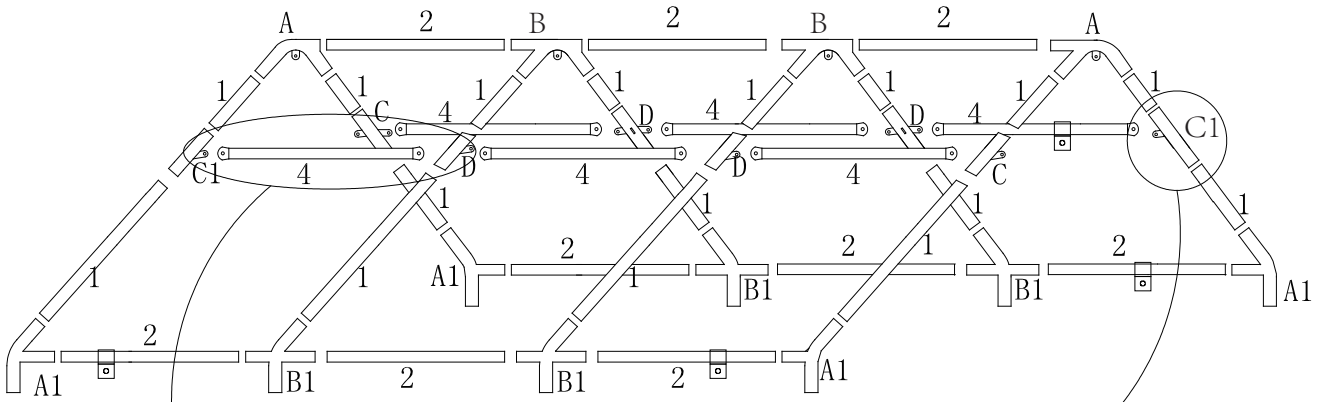

M6*16 x 16

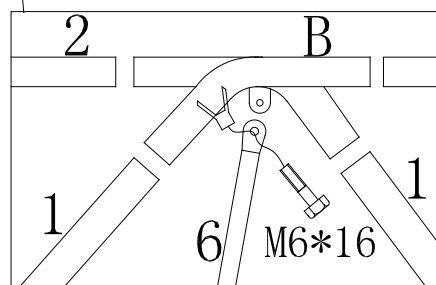
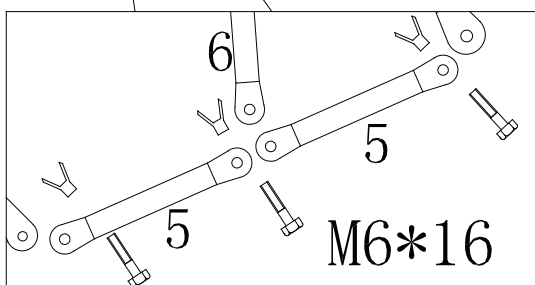
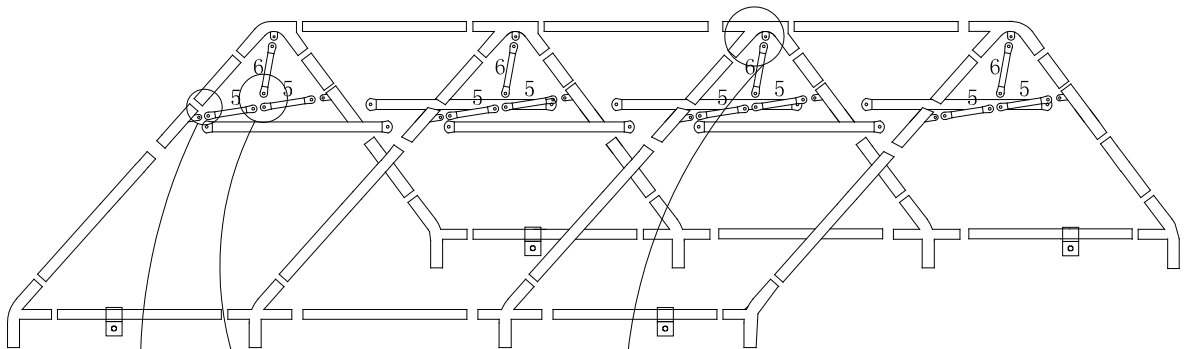

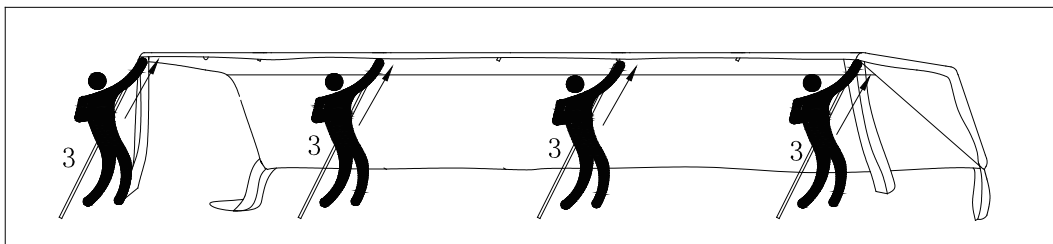
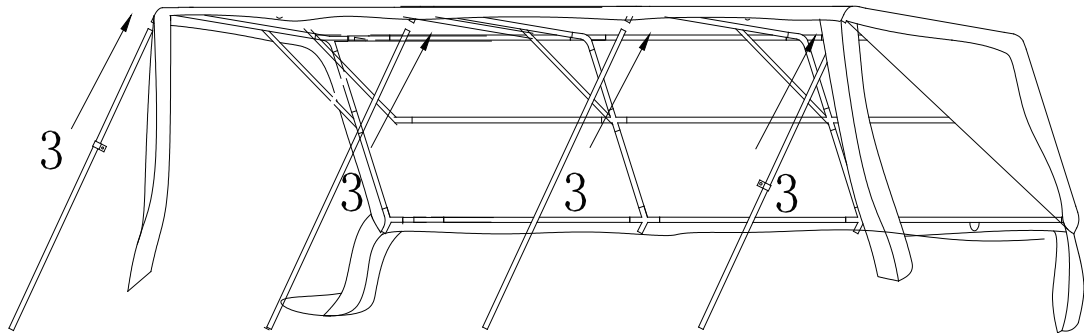
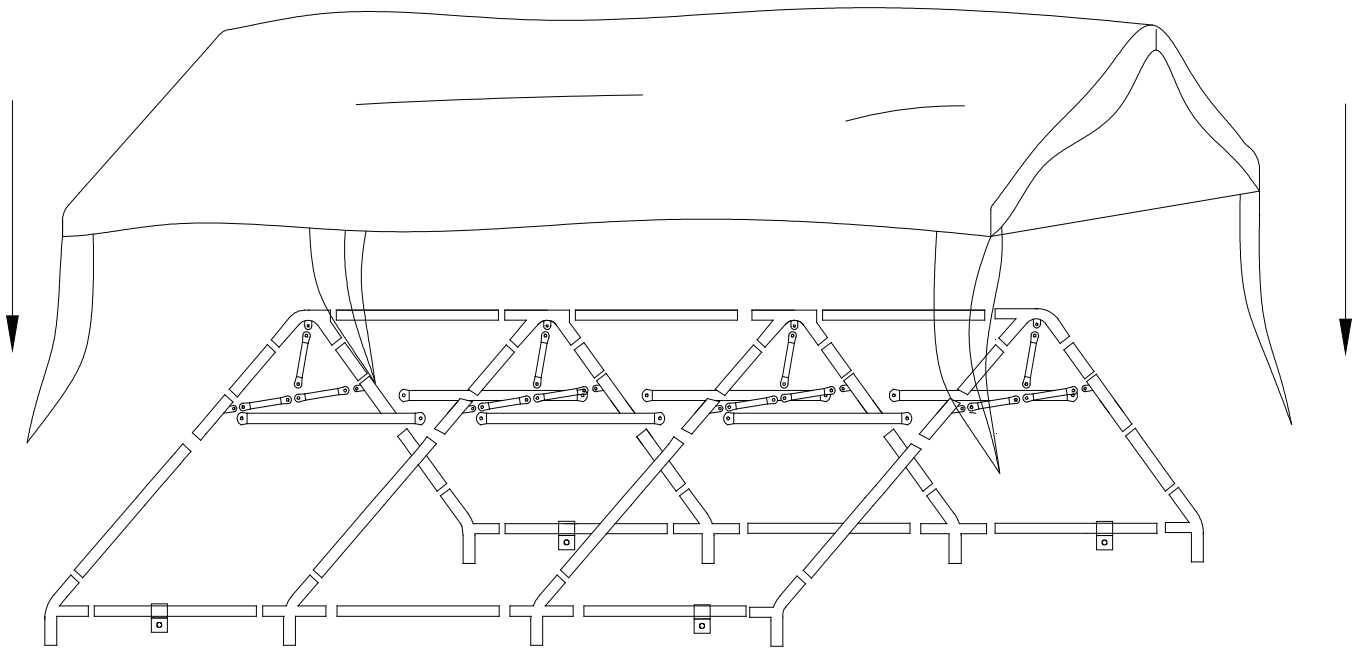

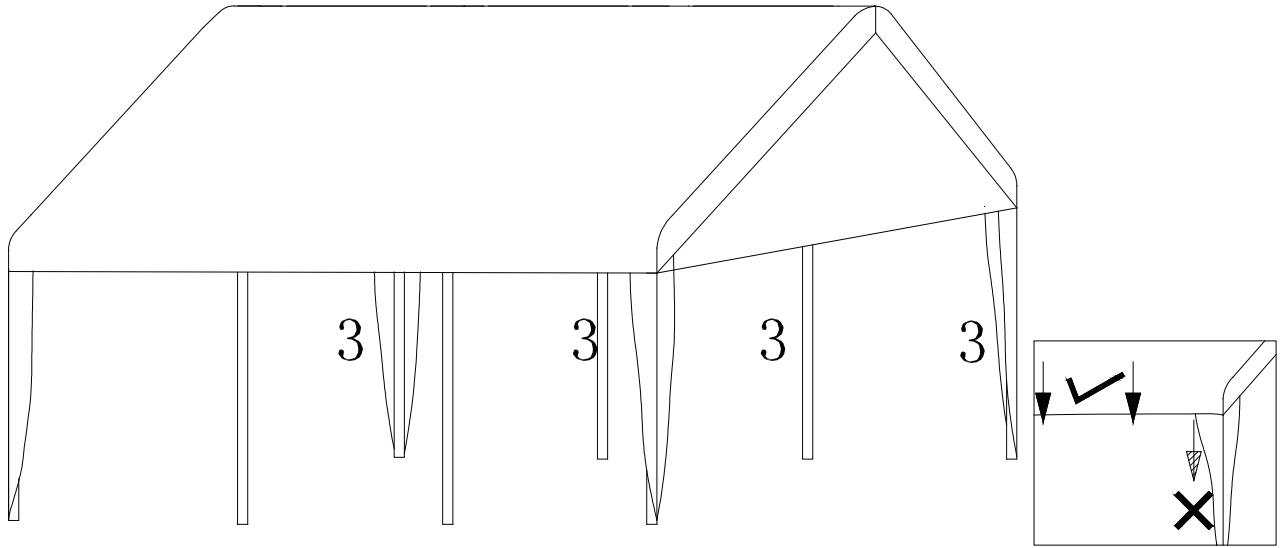

M8*50 x 8 M6*25 x 8

