

BOOKSHELF

ASSEMBLY MANUEL

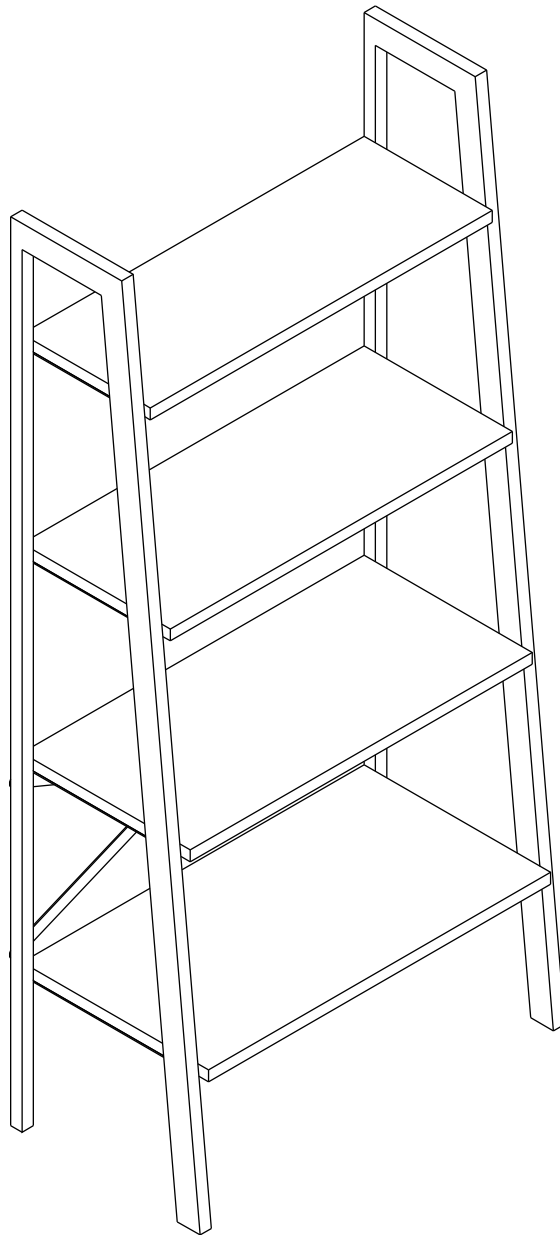

In order to provide better service to you again and gain to the production process of the use of non-recycled waste material support, please let us ... Let us preserve the environment for a better WORLD... Thank you for choosing us :)

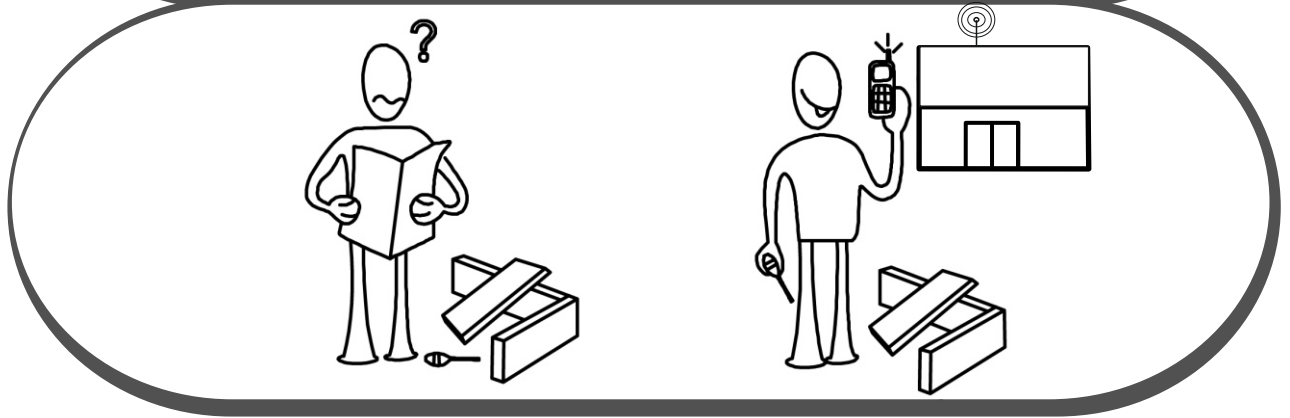
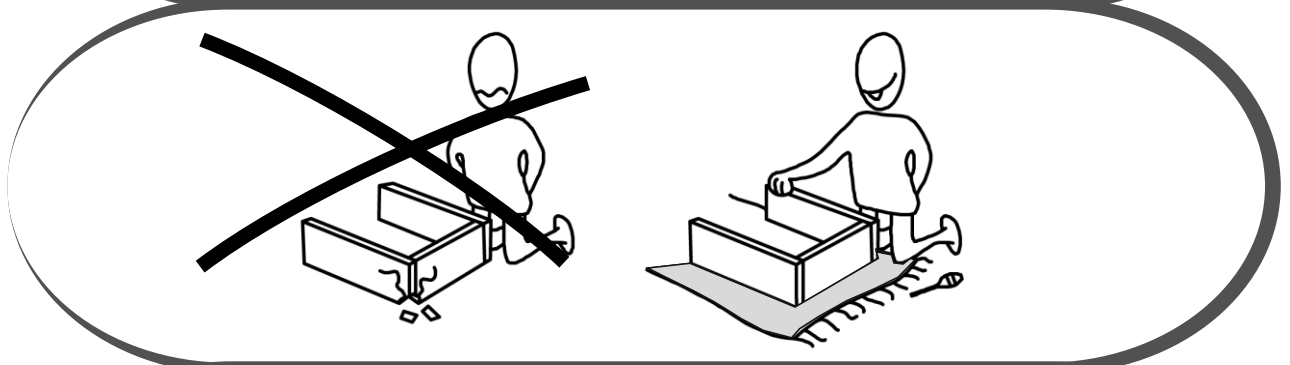
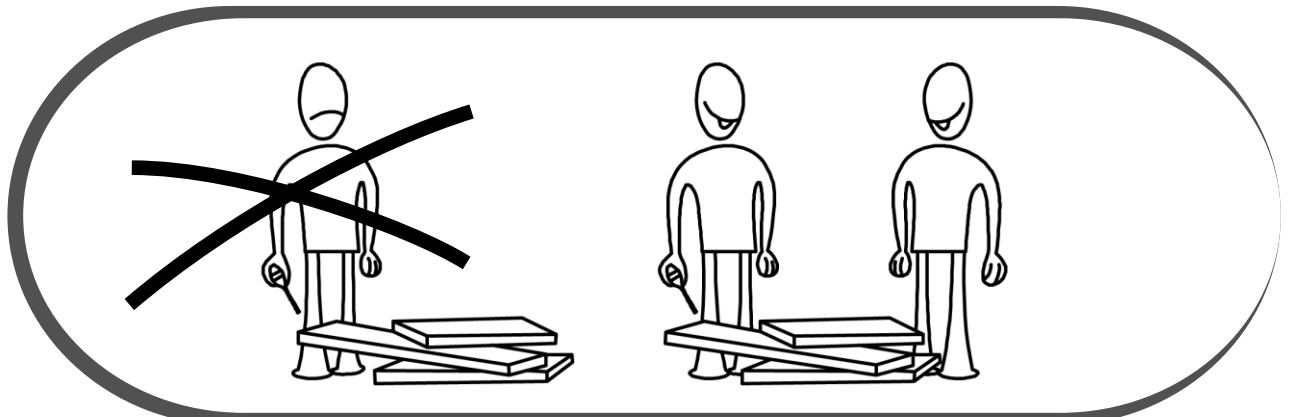

Dear Customer,

The product you bought was subjected to all sorts of tests and control before sending out to you. Even in this situation, sometimes happen that some component is damaged during the transportation. In such case please do not send the whole article back to us. Just request/order the damaged part. While requesting the required part, describe it exactly by looking to service card. Missing part will be sent to you as soon as possible. Before start assembling, please check the whole components and accessories according to the lists. After being sure that every part and accessory are okay and right, start assembling. Before start assembling, please clean all the components with a damp cloth. If you bought more than one product, to prevent confusion be sure that you completed the first product. Then start the other product's assembling. Never draw the products. While carrying, disassociate and lift the product and carry with minimum 2 people. For long distances carry the product with the package.

It is very easy to clean the surfaces of your product. It is enough to wipe with a damp and soapy cloth or other household cleaners. Do not directly contact your furniture with excessive heat, cold and humidity because the product can be affected.

ATTENTION!!



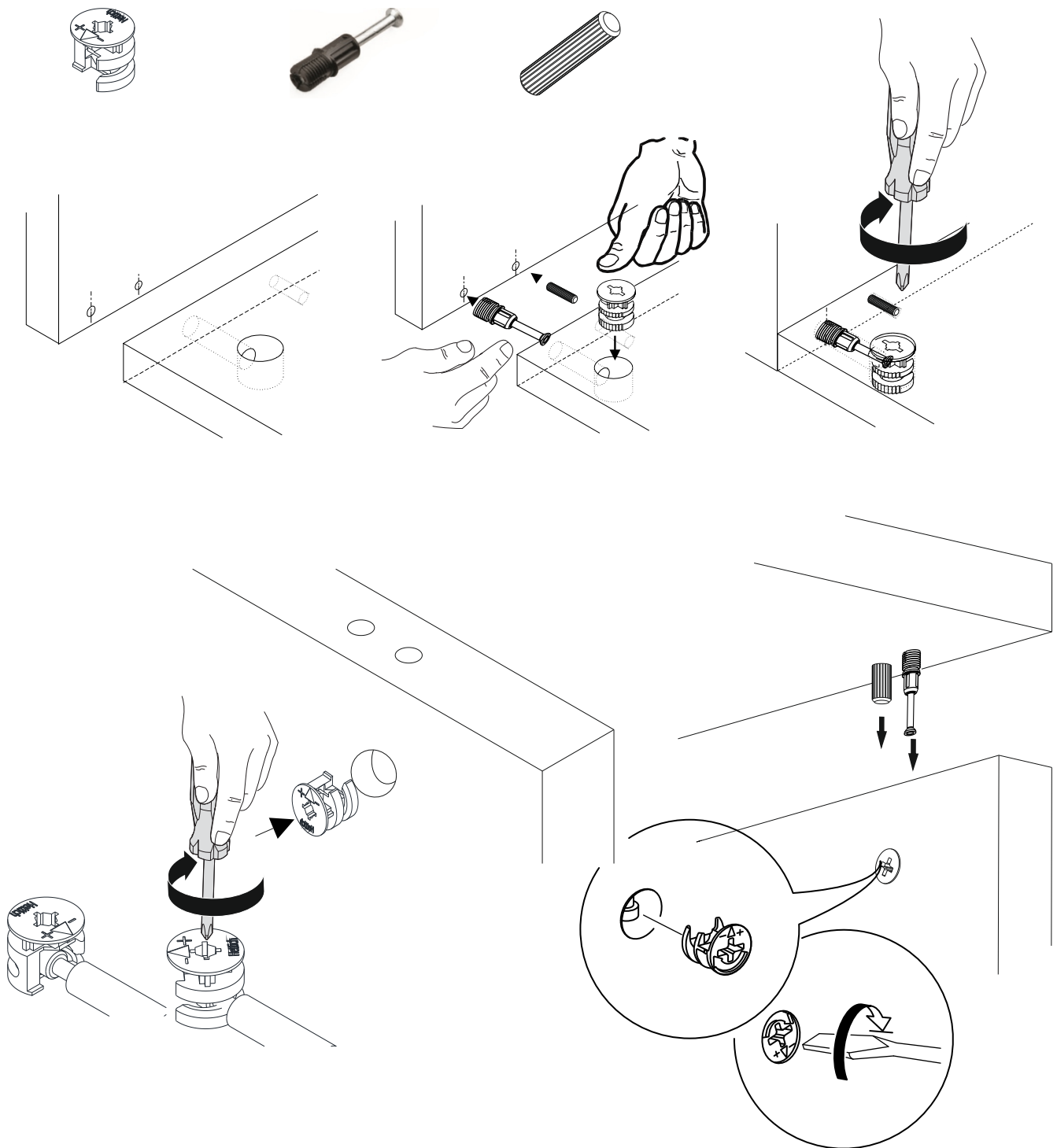

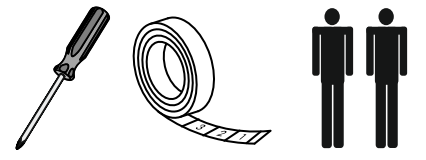
Minifix is the main connection material used in products.
Before starting assembly, please check the drawings below...



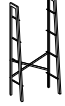

The necessary tools (not included)

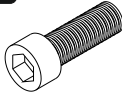
ZUBEHÖRLİSTE/ACCESSORY LIST/AKSESUAR LİSTESİ

B74 Demir  1x	A10 3,5x18 YHB Vida  16x	A50 M6X15 Alyan Başlı Vida  4x	A26 5mm  1x
---	--	---	---

GENERAL VIEW

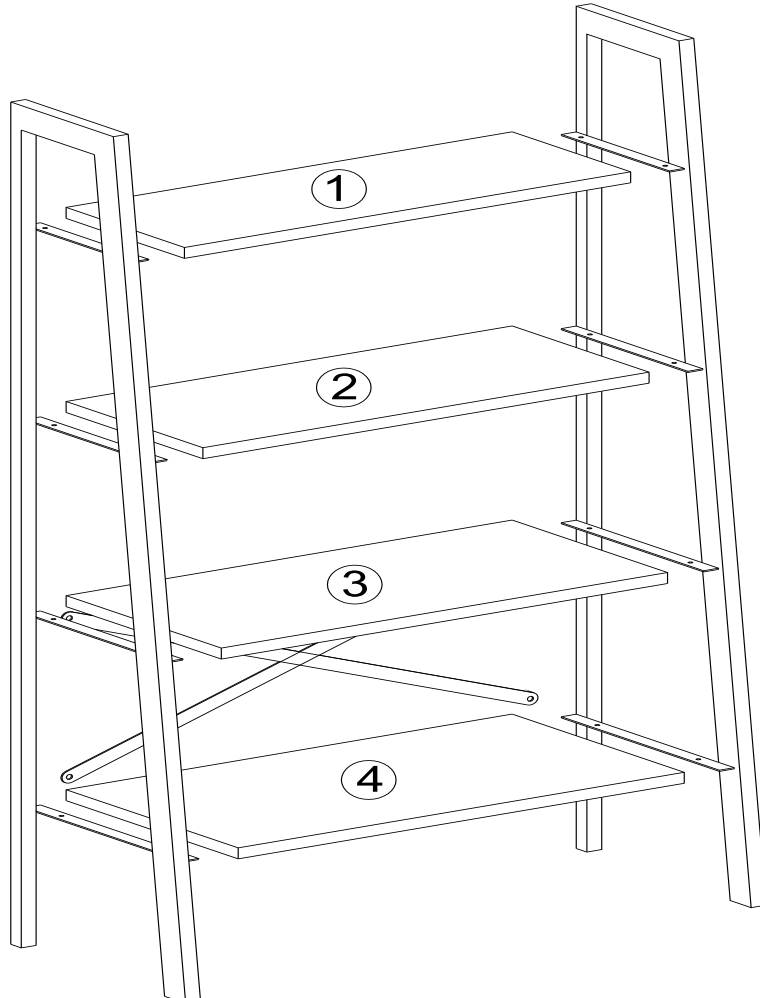

ASSEMBLY MANUAL

