

## Drawer Cabinet > Manual

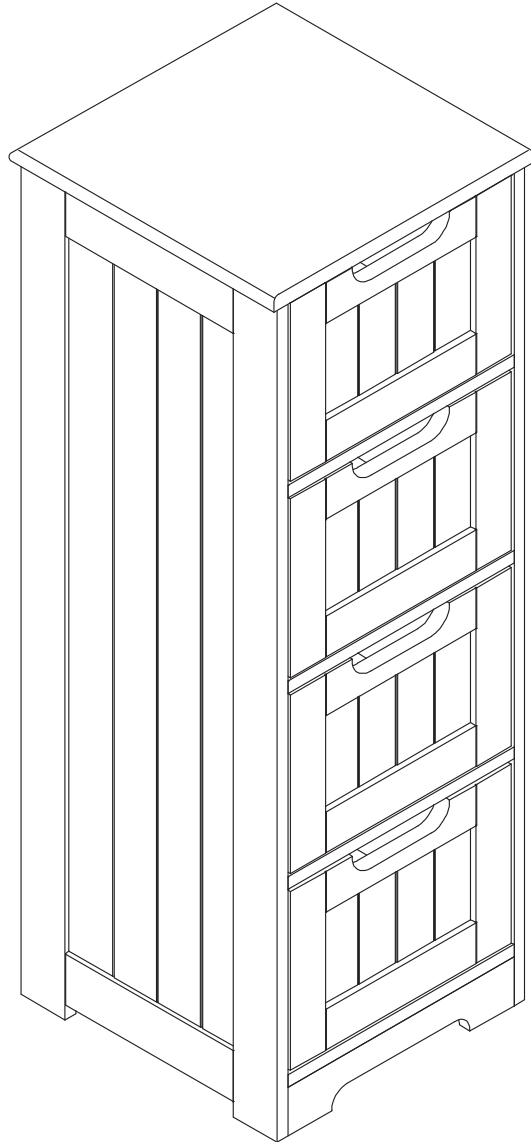

Thank you for purchase on our products. Please contact us if you have difficulty with assembly or need replacement parts. Our customer service is here to assist you. Please attach your User Name or Order ID so that we can assist you better.

Vielen Dank für Ihren Kauf von uns Produkten. Bitte kontaktieren Sie uns, wenn Sie Probleme mit Montage haben oder Ersatzteile benötigen. Wir Kundenservice ist für Sie da. Bitte geben Sie Ihren Benutzernamen oder Ihre Bestellnummer an, damit wir Sie besser unterstützen können.

**EN**



## **WARNING**

### **The product must be assembled by adult before use.**

Serious or fatal injury may occur from unexpected assembly or use.

1. During the assembly process, keep all parts away from babies or children.
2. Always securely fix this product to the wall. Make sure the wall area to be drilled is free from hidden electrical wires, water and gas pipes.
3. Use of tip-over restraints may only reduce, but not eliminate the risk of tip-over.
4. Unless specially designed to accommodate, do not set heavy objects on top of this product.
5. Place the heaviest items on the lowest shelf.
6. Never allow children to climb or bang on drawers, doors or shelves.

**DE**



## **WARNUNG**

### **Der Produkt muss vor Gebrauch von einem Erwachsenen zusammgebaut werden.**



Bei unerwarteter Montage oder Verwendung können schwere oder tödliche Verletzung auftreten.

1. Legen Sie in den Montageprozess alle Teile weg von Babys oder Kindern.
2. Befestigen Sie dieses Produkt immer sicher an der Wand. Um sicherzustellen, dass der zu bohrende Wandbereich entfernt von verdeckten Stromkabeln, Wasser- und Gasleitungen ist.
3. Die Verwendung von Kippsicherungen kann die Gefahr eines Kippens nur verringern, jedoch nicht beseitigen.
4. Setzen Sie bitte keine schweren Gegenstände auf dieses Produkt, es sei denn, dass das Produkt speziell für die Unterbringung konzipiert wird.
5. Legen Sie bitte die schwersten Gegenstände auf das unterste Regal.
6. Erlauben Sie nie Kindern, auf Schubladen, Türen oder Regale zu klettern oder zu knallen.

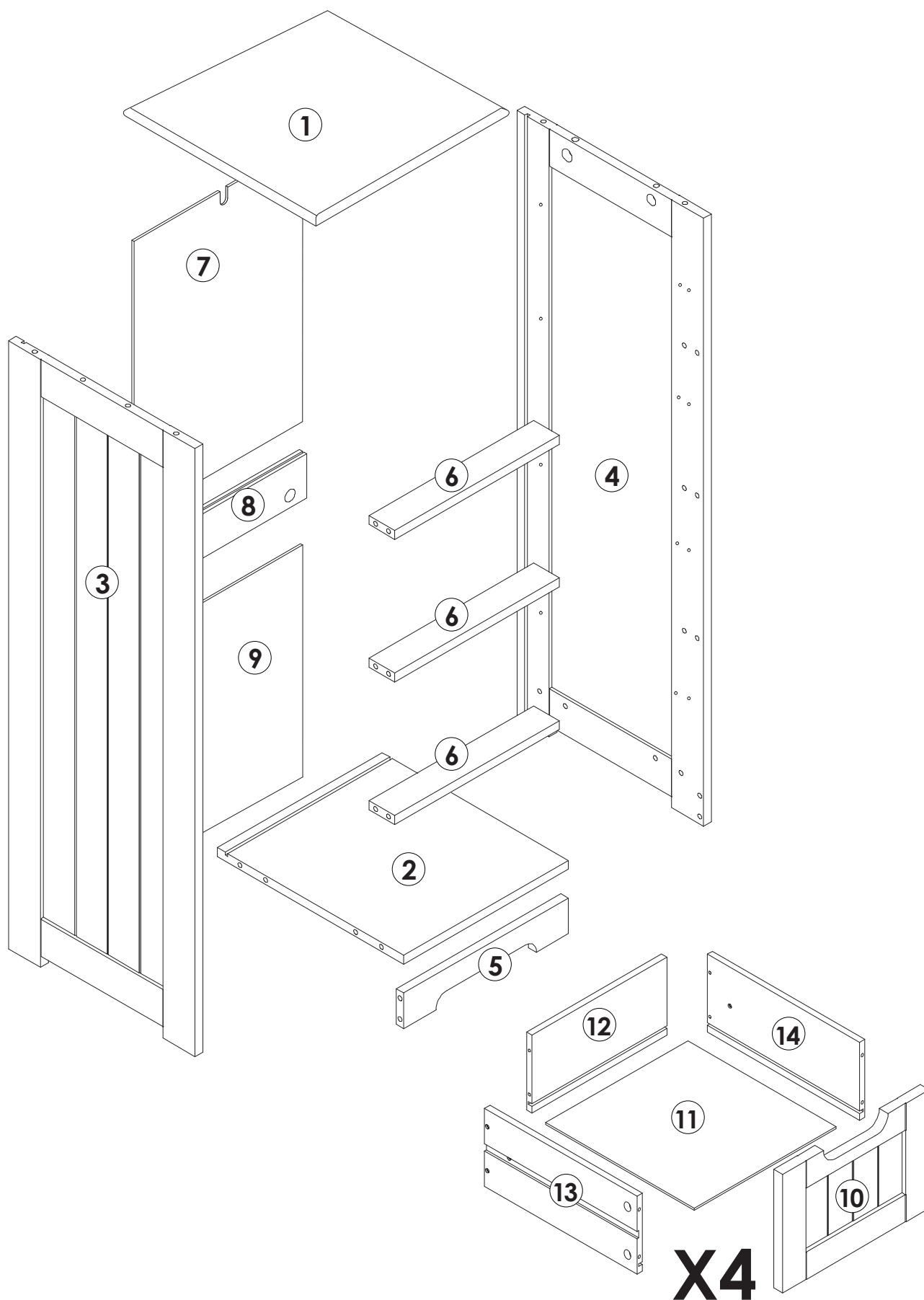
# Parts List(EN) / Teile Liste(DE)

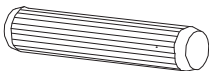
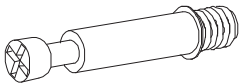
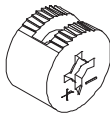
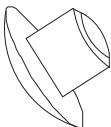
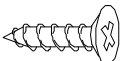
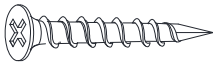
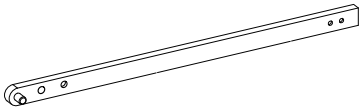
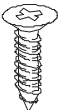
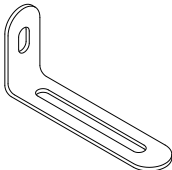
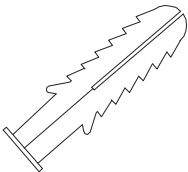
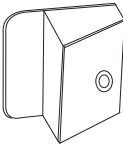
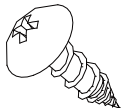

## Parts List(EN) / Teile Liste(DE)





<p><b>A</b></p>  <p>Φ6x30mm      18+2PCS</p>	<p><b>B</b></p>  <p>M6x35mm      34+2PCS</p>	<p><b>C</b></p>  <p>Φ15x9.5mm      34+2PCS</p>
<p><b>D</b></p>  <p>M6.5X14mm      8+1PCS</p>	<p><b>E</b></p>  <p>M3x12mm      16+2PCS</p>	<p><b>F</b></p>  <p>M4x30mm      16+2PCS</p>
<p><b>G</b></p>  <p>8PCS</p>	<p><b>H</b></p>  <p>M3x14mm      8+1PCS</p>	<p><b>I</b></p>  <p>1PC</p>
<p><b>J</b></p>  <p>M6x30mm      1PC</p>	<p><b>K</b></p>  <p>8+1PCS</p>	<p><b>L</b></p>  <p>M4x10mm      1PC</p>
<p><b>M</b></p>  <p>M4x35mm      1PC</p>		

## Assembly Steps(EN) / Montageschritte(DE)

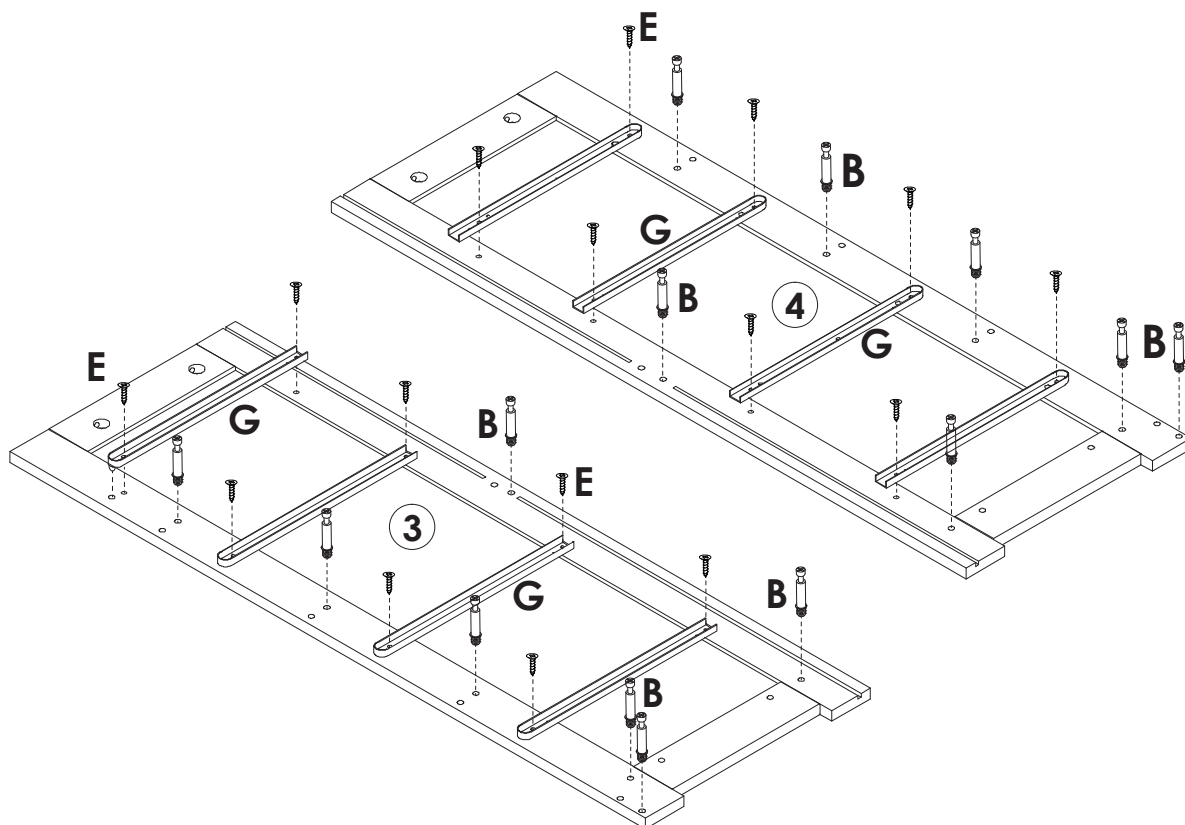
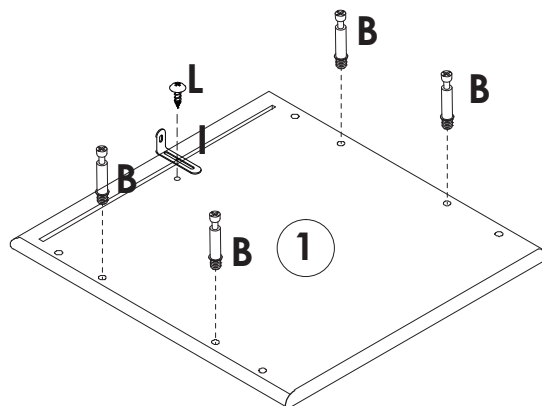
### STEP 1

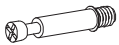
Lock the long side of the "I" L-shaped metal plate to the ① board with the "L" short screw





	<b>B</b> x 18PCS
	<b>E</b> x 16PCS
	<b>G</b> x 8PCS
	<b>I</b> x 1PC
	<b>L</b> x 1PC

# Assembly Steps(EN) / Montageschritte(DE)

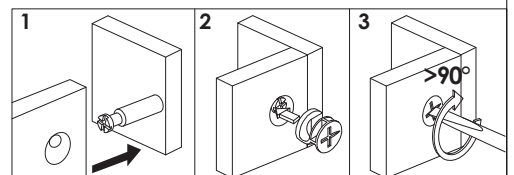
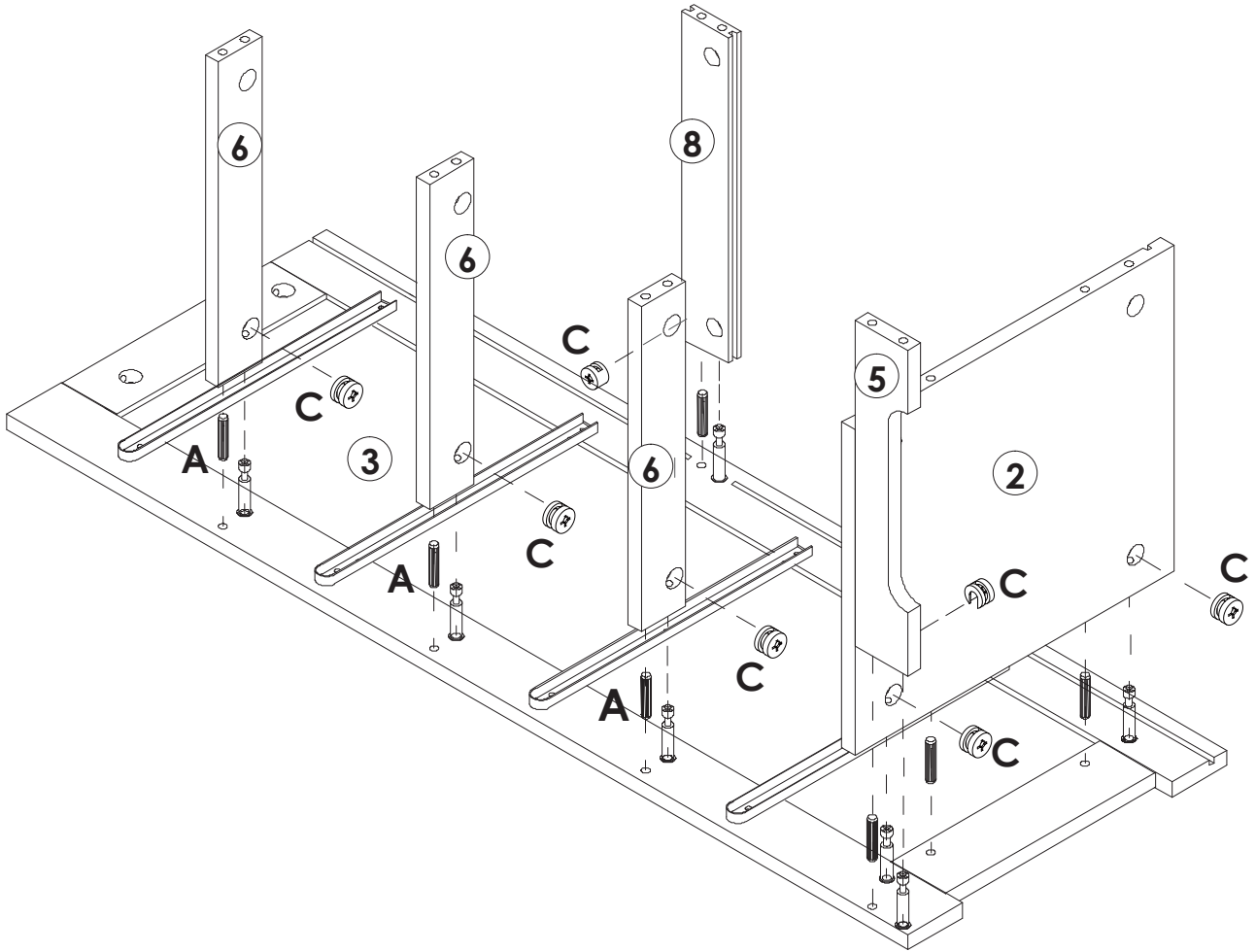
## STEP 2



	<b>A</b> x 7PCS
	<b>C</b> x 7PCS

# Assembly Steps(EN) / Montageschritte(DE)

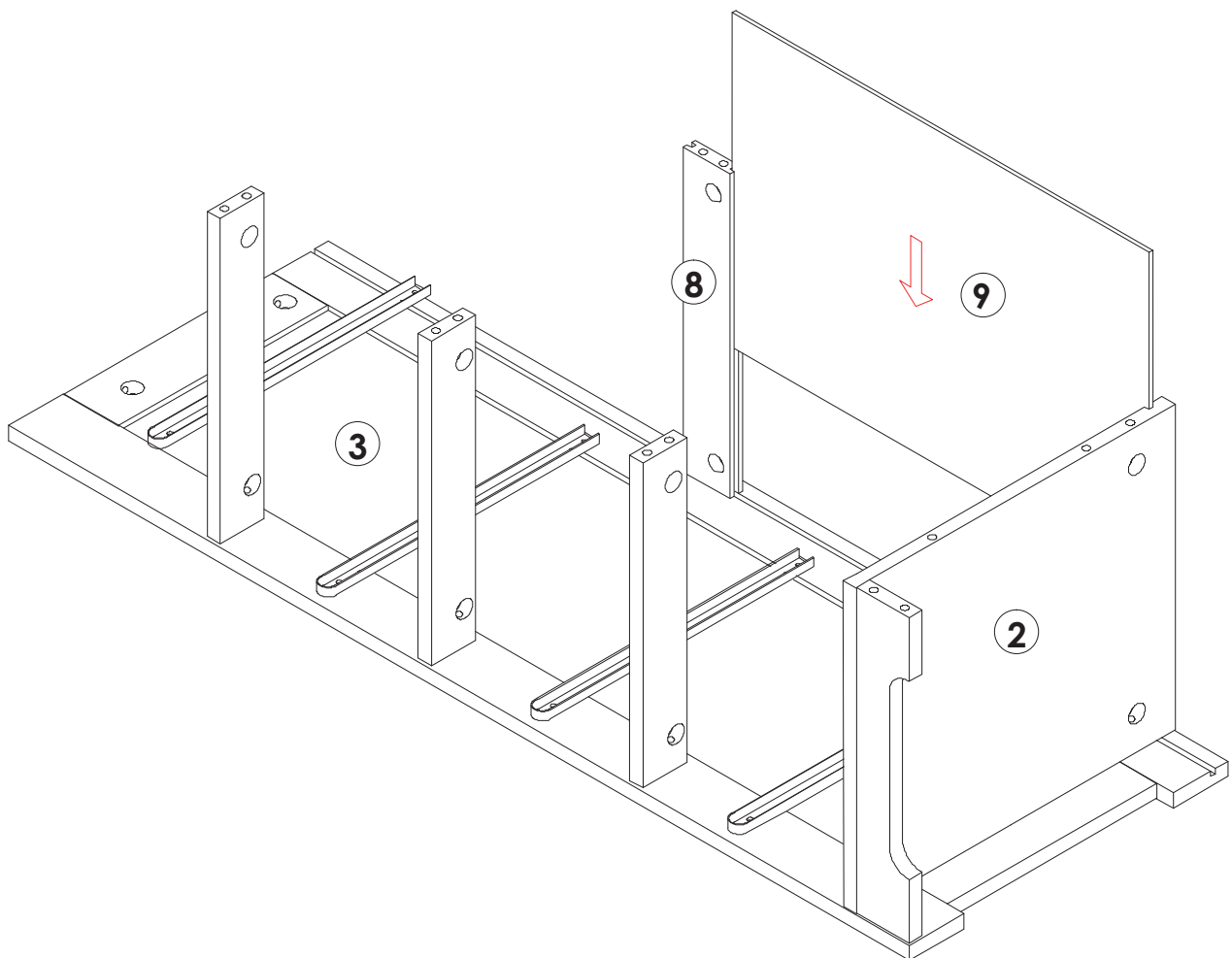

## STEP 3

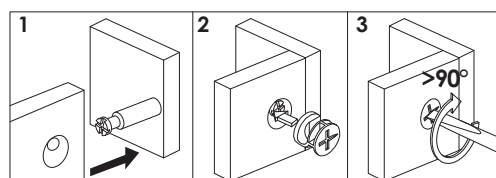
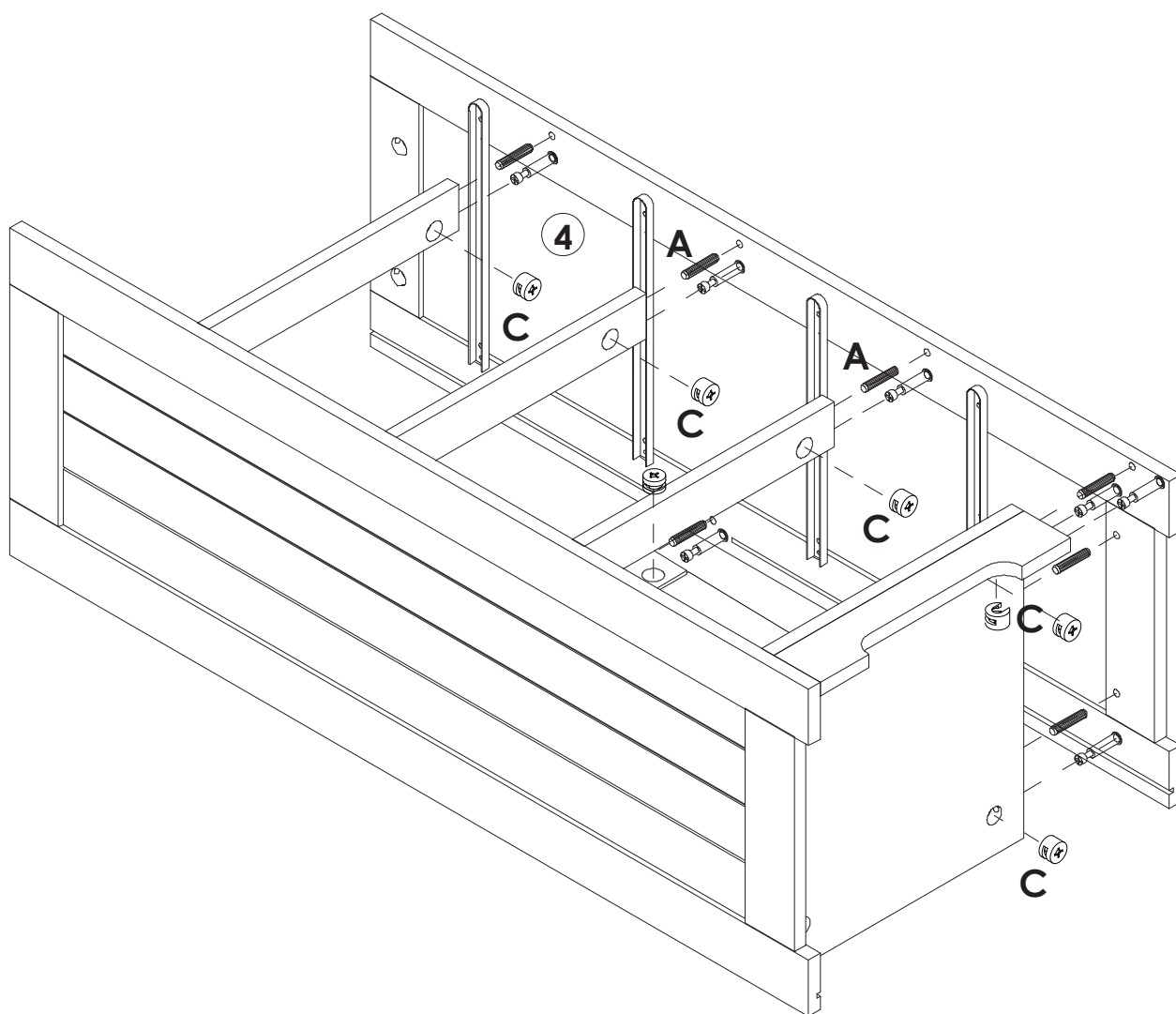

# Assembly Steps(EN) / Montageschritte(DE)

## STEP 4



	<b>A</b> x 7PCS
	<b>C</b> x 7PCS

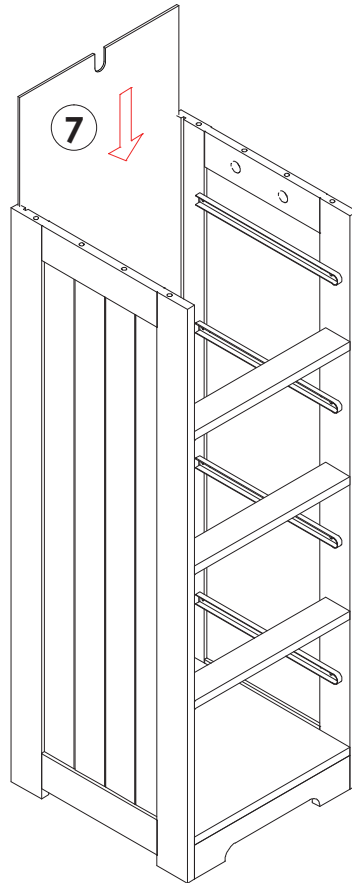

# Assembly Steps(EN) / Montageschritte(DE)

## STEP 5

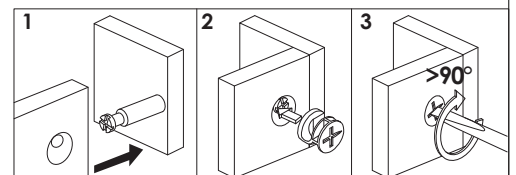
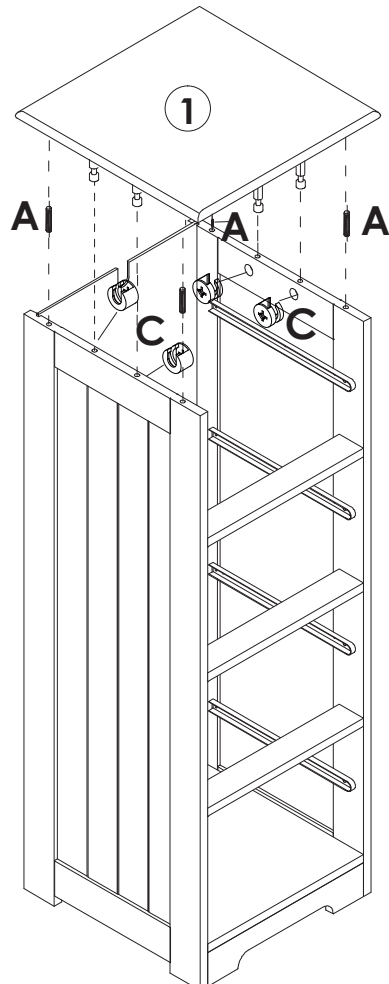

## STEP 6





	<b>A</b> x 4PCS
	<b>C</b> x 4PCS

# Assembly Steps(EN) / Montageschritte(DE)

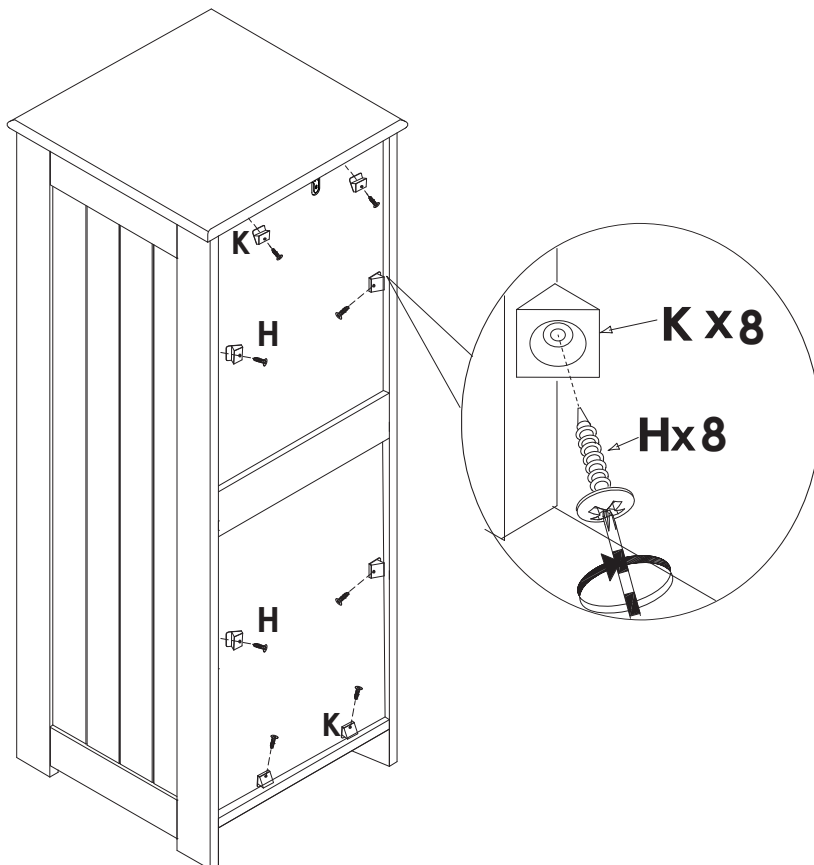
## STEP 7



	<b>k x 8PCS</b>
	<b>H x 8PCS</b>

## STEP 8

Drill a hole on the wall at the required position for anti-falling device installation.

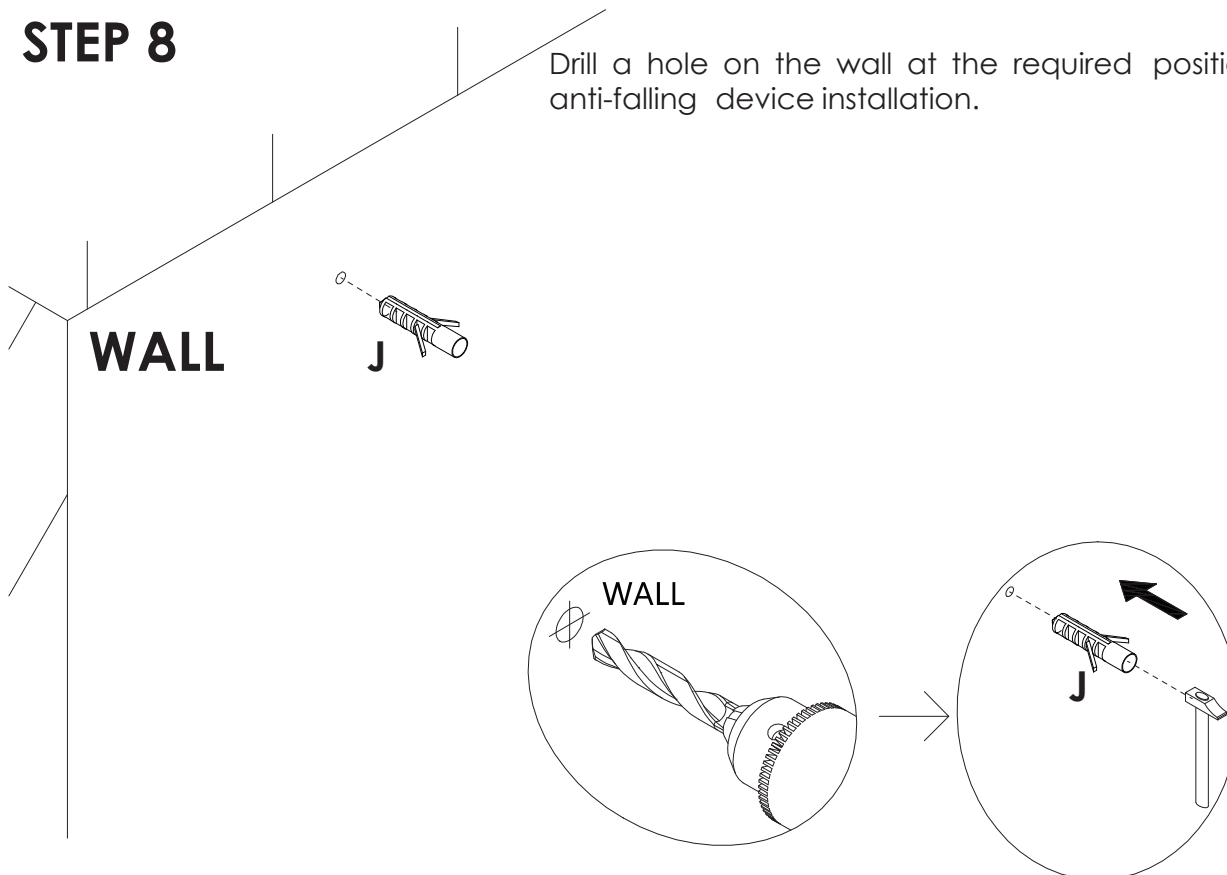

	<b>J x 1PC</b>
---	----------------

## Assembly Steps(EN) / Montageschritte(DE)

### STEP 9

Move the cabinet to the required position, use the "M" long screw to fix the cabinet to the wall.

WALL

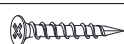
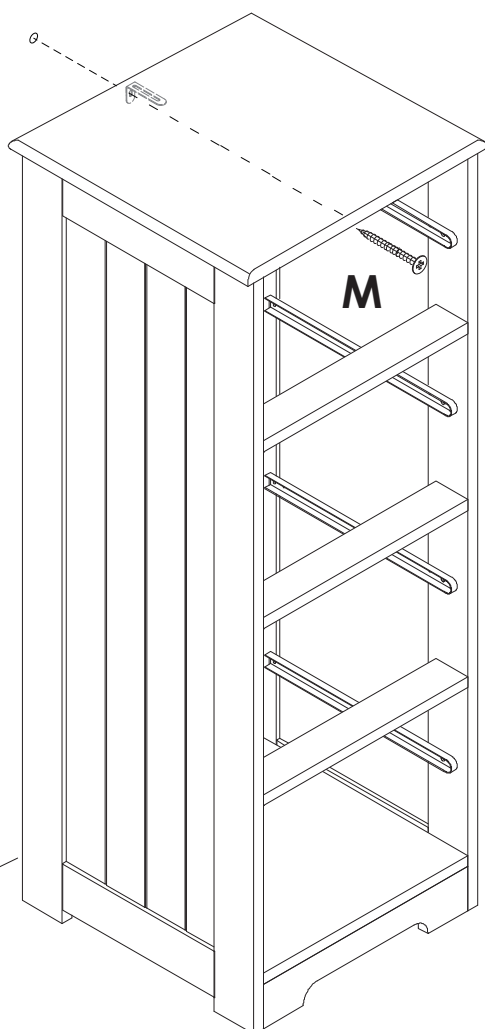
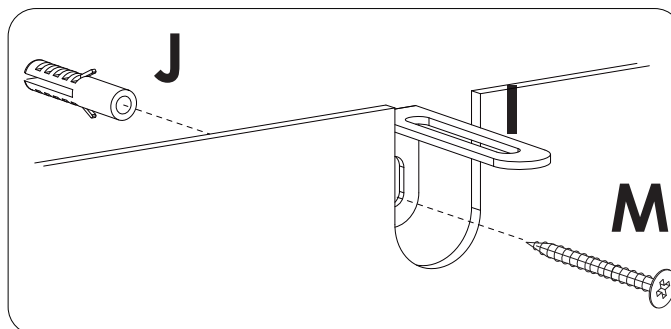

M x 1PC

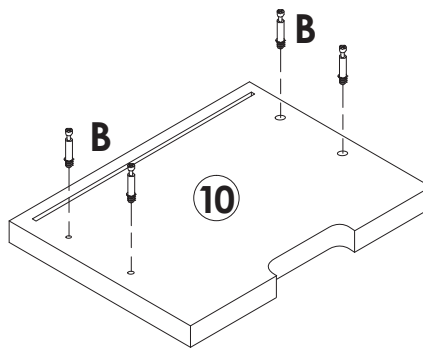
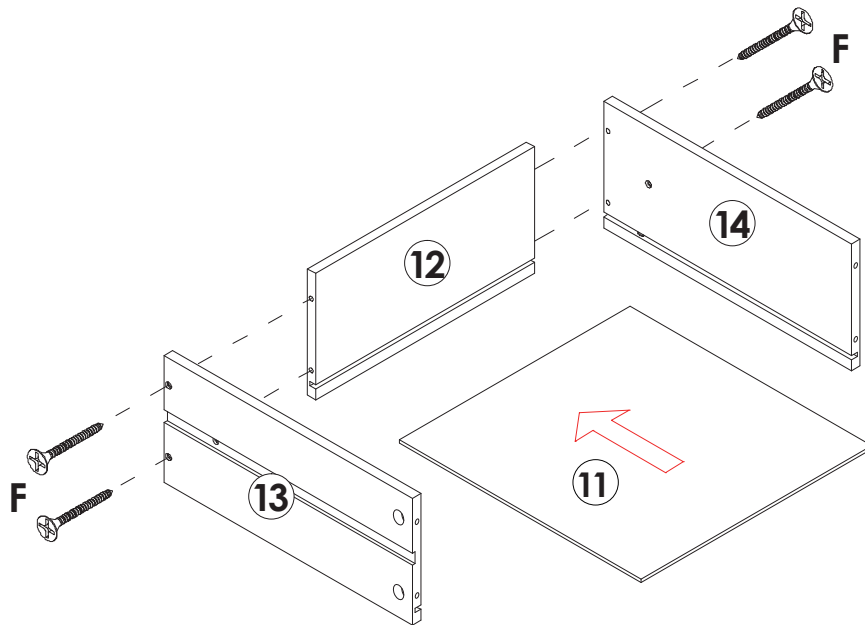

# Assembly Steps(EN) / Montageschritte(DE)

## STEP 10

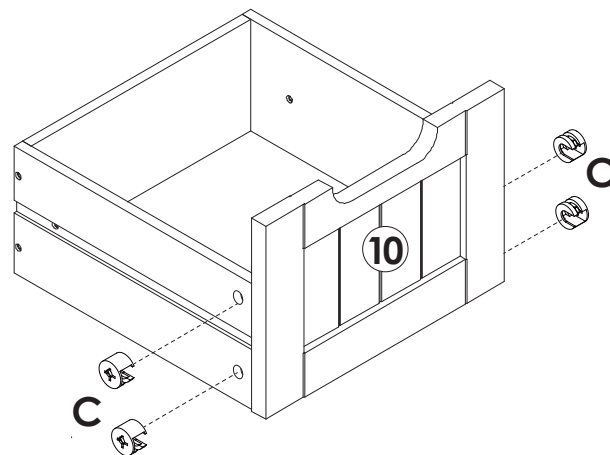

**X4**



	<b>B x 16PCS</b>
	<b>C x 16PCS</b>
	<b>F x 16PCS</b>

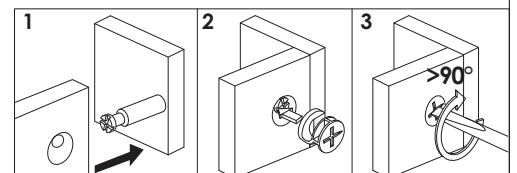

# Assembly Steps(EN) / Montageschritte(DE)

## STEP 11

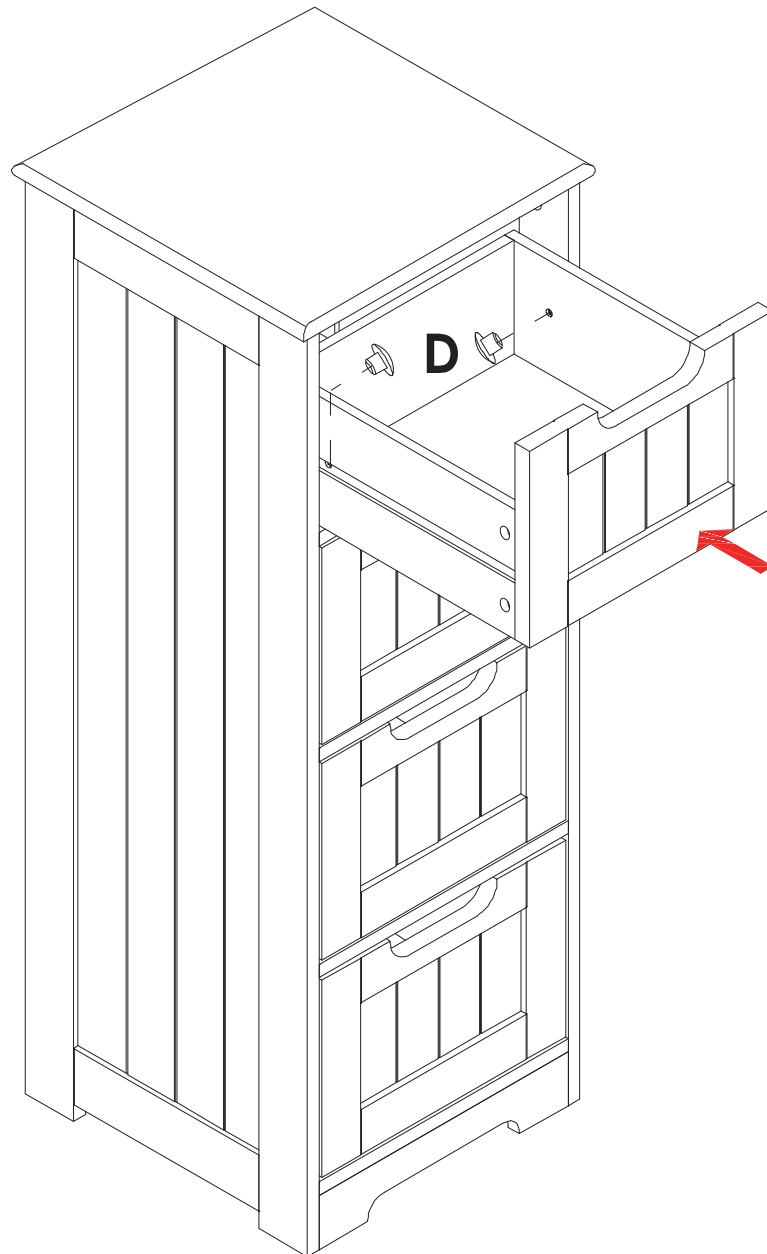

**D** x 8PCS



## WARNING



Children have died from furniture tipover. To reduce the risk of furniture tipover:

- **ALWAYS** install Anti-tip device provided.
- **NEVER** put a TV on this product.
- **NEVER** allow children to stand, climb or hang on any drawers, doors, or shelves.
- **NEVER** open more than one drawer at a time.
- Place heaviest items in the lowest drawers.



***This is a permanent label.  
Do not remove!***