

Assembly Instruction
Contains One Bed and Hardware

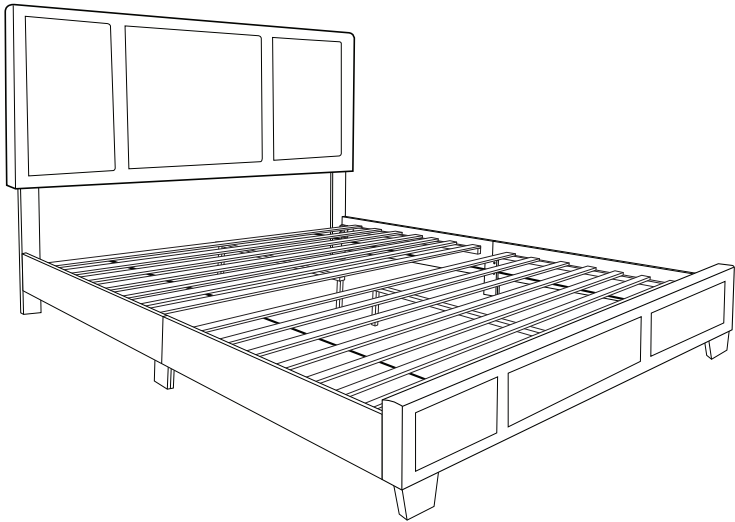

IMPORTANT NOTE:

Carefully remove all the parts from the box. Arrange on a flat surface and verify you have all of the following parts and hardware

TOOLS REQUIRED:
Phillips Screwdriver

PARTS LIST

A. Headboard (1 pc)

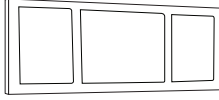

B. Headboard Legs (2 pcs)

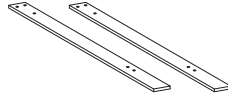

C. Side Rail (4 pcs)

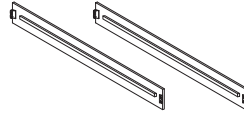

D. Footboard (1 pc)



E. Side Rail Support Leg (2 pcs)

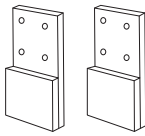

F. Center Leg (4 pcs)

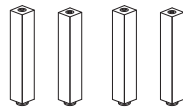

G. Footboard Legs (2 pcs)

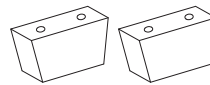

H. Wood Slat (14 pcs)

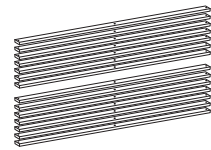

I. Center Support Rail (2 pcs)



HARDWARE LIST

1. 20mm Bolt (8 pcs)

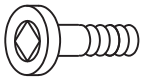

2. Flat Washer (14 pcs)



3. Spring Washer (14 pcs)



4. Wood Dowel M8 (4 pcs)

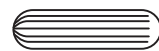

5. 25mm Bolt (20 pcs)

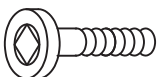

6. 40mm Bolt (6 pcs)

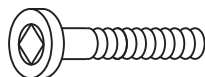

7. 60mm Bolt (4 pcs)

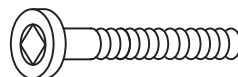

8. 70mm Bolt (2 pcs)

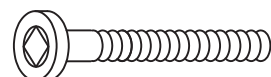

9. 32mm Screw (28 pcs)



10. Adjuster (4 pcs)



11. Small Hex Key (1 pc)



12. Large Hex Key (1 pc)



ASSEMBLY INSTRUCTIONS

STEP 1

Attach headboard legs(Part B) to the headboard(Part A) using three 40mm bolts (Part 6) and three spring washer(Part 3) and three flat washer (Part 2) per leg. Secure tightly using small hex key(Part 11).

This headboard is adjustable. To make the Headboard taller (47" from floor to top of headboard), attach the headboard legs to the bottom 3 holes. To make the headboard shorter (45" from floor to top of headboard), attach the headboard legs to the top 3 holes.

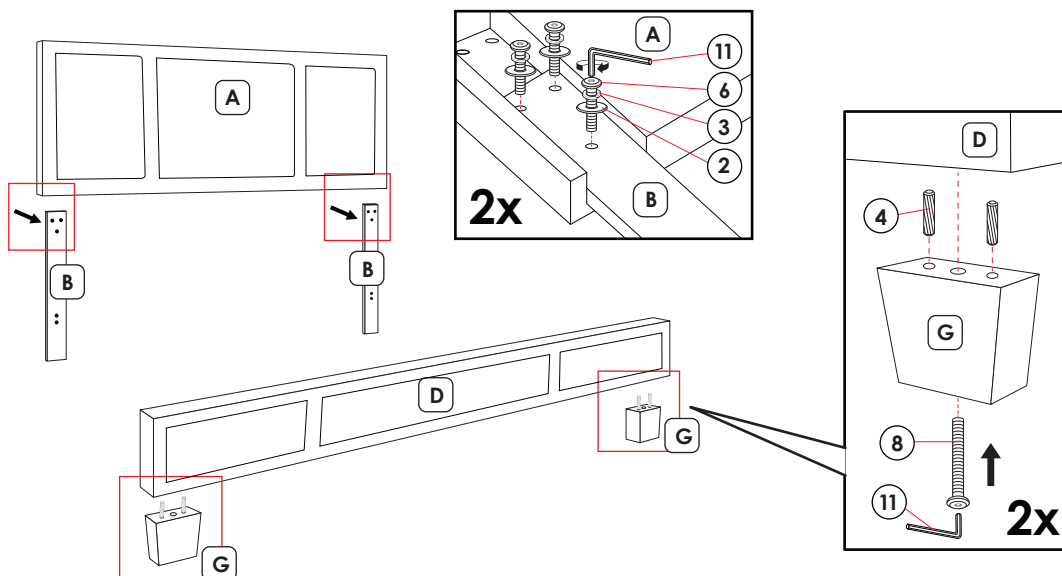

Attach the footboard legs(Part G) to the footboard(Part D) using two wood dowel M8(Part 4) and one 70mm bolts(Part 8) and small hex key(Part 11). Secure tightly.

STEP 2

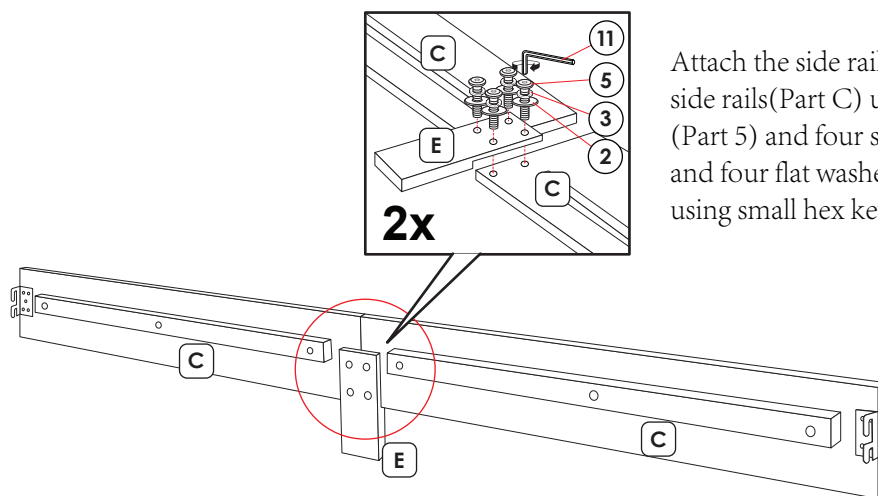

Attach the side rail legs(Part E) to the side rails(Part C) using four 25mm bolts (Part 5) and four spring washer(Part 3) and four flat washer(Part 2). Tighten using small hex key(Part 11).

ASSEMBLY INSTRUCTIONS

STEP 3

Attach the eight 20mm bolts (Part 1) to the headboard leg (Part B) and footboard (Part D) using the large hex key (Part 12). Do not tighten.

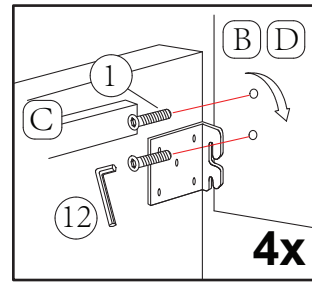
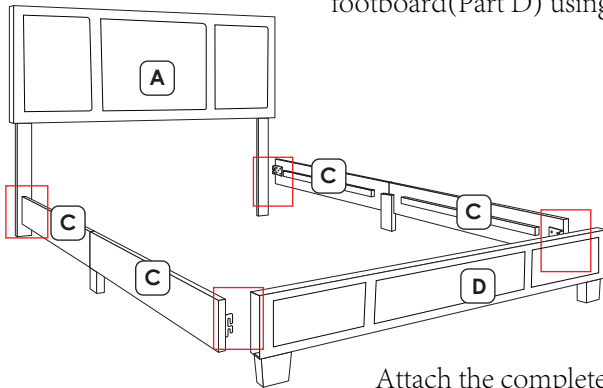

Attach the complete side rail to headboard (Part A) and footboard (Part D) by sliding the side rail brackets onto the bolts on the headboard legs (Part B) and footboard (Part D). Do not tighten yet.

STEP 4

Attach four center leg (Part F) to the slats (Part H) using 60mm bolt (Part 7). Tighten the bolt using small hex key (Part 11). Repeat the step for all four support leg.

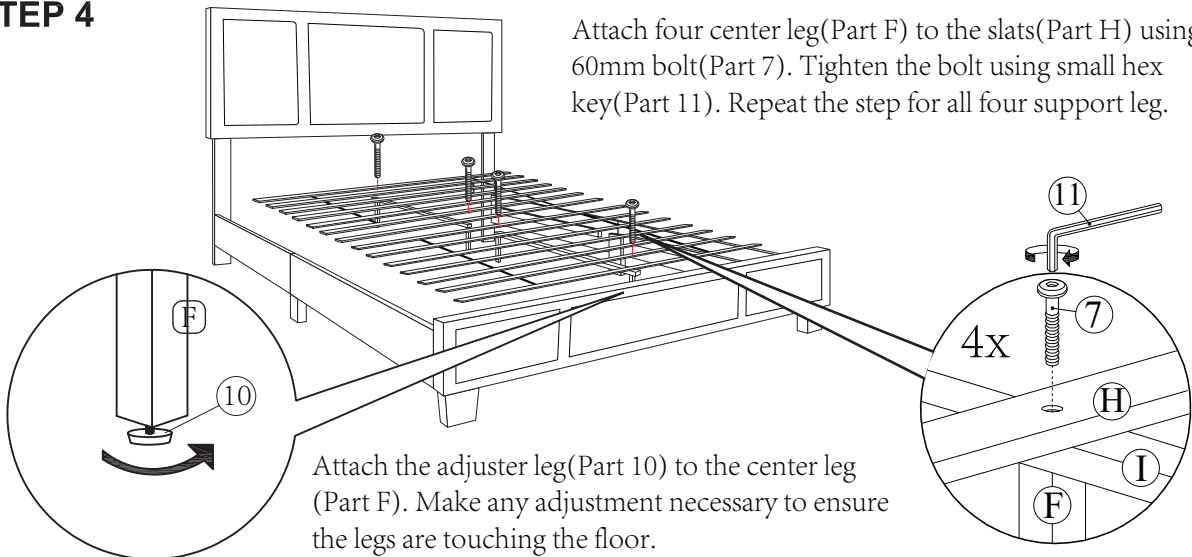

Attach the adjuster leg (Part 10) to the center leg (Part F). Make any adjustment necessary to ensure the legs are touching the floor.

STEP 5

Place the 14 slats into the bed as shown. Tighten the bolts on the headboard legs and footboard using large hex key (Part 12). Secure the 14 slats using twenty eight screws (Part 9) and a Phillips Screwdriver. Your bed is now set up and ready for use.

