

HEALTH CAUTION

- ⌘ If you have any concerns regarding your health, consult your doctor before using this product.
- ⌘ Individuals with pacemakers should not use this product.
- ⌘ If you experience pain in a muscle or joint for a prolonged period of time. Discontinue use and consult your doctor. Persistent pain could be a symptom of a more serious condition.

MAINTENANCE INSTRUCTIONS

TO STORE:

Place unit in its box or safe, dry, cool place. Avoid contact with sharp edges or pointed objects which might cut or puncture the fabric. Do not wrap power cord around the unit. Do not hang the unit by power cord.

TO CLEAN:











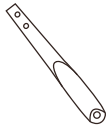
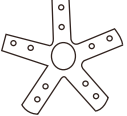
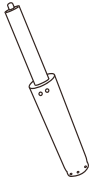
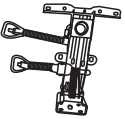

- ⌘ Insure the unit is unplugged from the power source, and allow to cool before cleaning.
- ⌘ Do not place in any liquid to clean. Clean fabric cover by wiping with a damp sponge, using a mild detergent or suds. Pat dry with clean, dry cloth.
- ⌘ Do not use abrasive cleaners, brushes, gasoline, kerosene, glass /furniturepolish, paint thinner or water hotter than 120°C to clean the unit.
- ⌘ To clean the unit, make sure the massager is unplugged. Allow the unit to cool and the wipe down with a damp clean cloth. Do not use any strong chemical cleaners.

OFFICE CHAIR ASSEMBLY INSTRUCTIONS

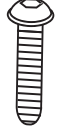
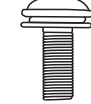
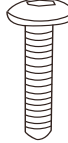

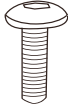
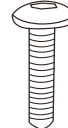
Assembly Instruction

Parts List

A	B	C	D	E	G	H
						
5 pcs	5 pcs	1 pc	1 pc	1 pc	1 pc	1 pc
I	J	K	L	M	N	O
						
1 pc	2 pcs	M6*20mm 10 pcs	M6*30mm 4 pcs	M8*25mm 4 pcs	M8*35mm 4 pcs	4 pcs
P	Q	R	S	T	U	
						
4 pc	M6*25mm 4 pc	M6*30mm 2 pc	M5*10mm 1 pc	1 pc	1 pc	

Please note: Please check carefully if there are any missing parts before installation. If there are any missing parts, please place all the parts and take pictures then tell us the missing part number. We will reply you as soon as possible.

Assembly Instruction

Chair Assembly

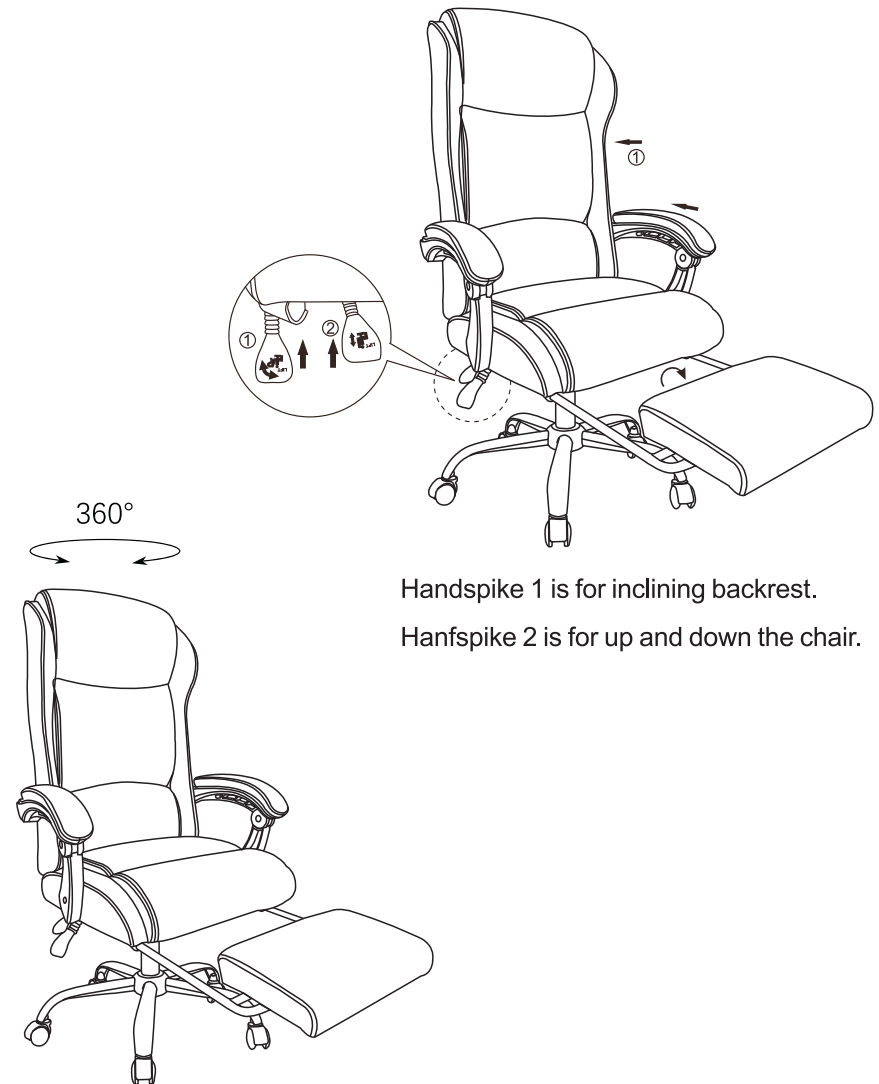

Assembly Instruction

Chair Assembly

Step 1

A*5

K*10

C*1

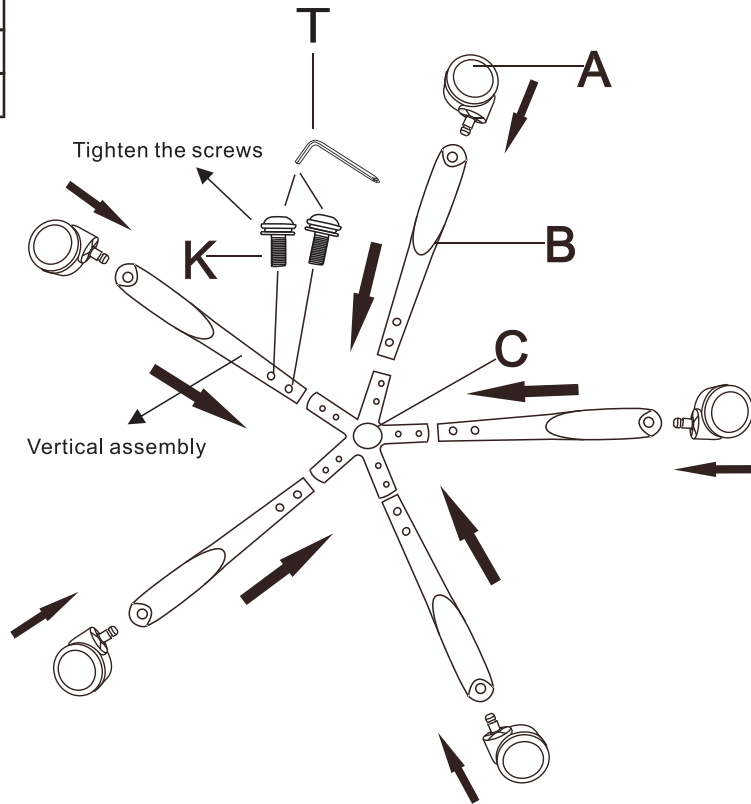

First, we need to prepare the connector (C), 5* metal feet (B), 5* universal wheels (A), 10*15mm screws (K) and a wrench (T). Then, according to the figure, insert the 5* metal feet into the connector, align the screw holes, install the screws and tighten them. Finally, a universal wheel is installed on the tail of each metal foot.

2

Assembly Instruction

Chair Assembly

Step 6

N*4

O*4

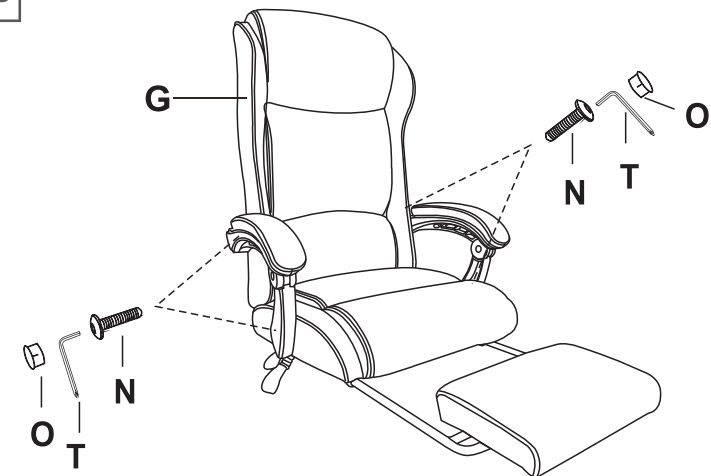

Step 7

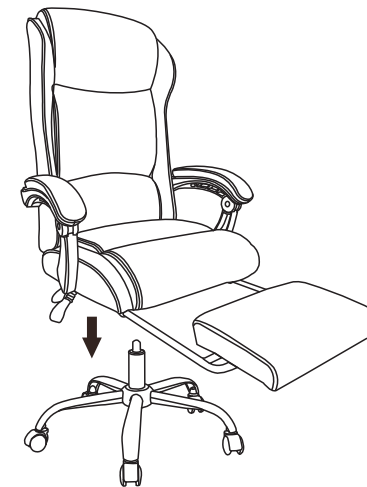

5

Assembly Instruction

Chair Assembly

Step 2

D*1

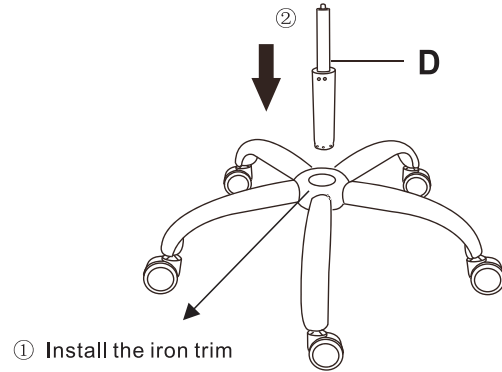

Step 3

Q*4

R*2

S*1

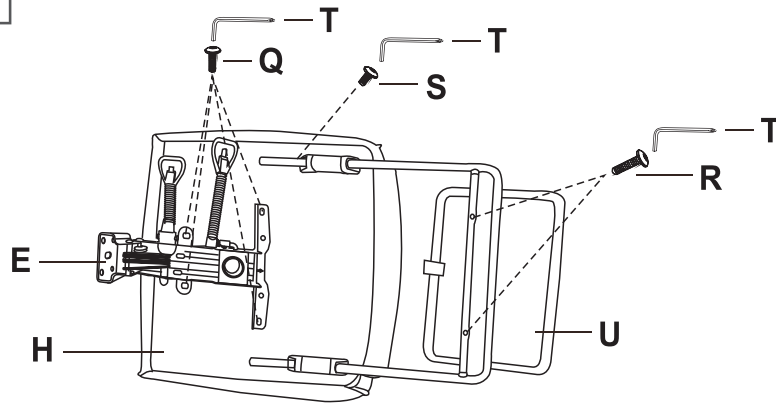

Fix the control unit to the base of the seat by screw (Q),
Then pull-out the footrest pole and fix the foot rest by
screw (R) & (S)

Assembly Instruction

Chair Assembly

Step 4

L*4

P*4

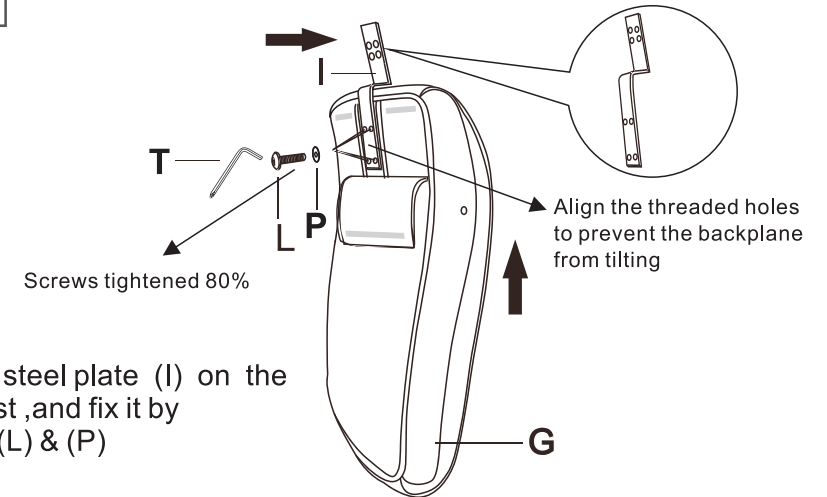

Put the steel plate (I) on the
backrest, and fix it by
screw (L) & (P)

Step 5

M*4

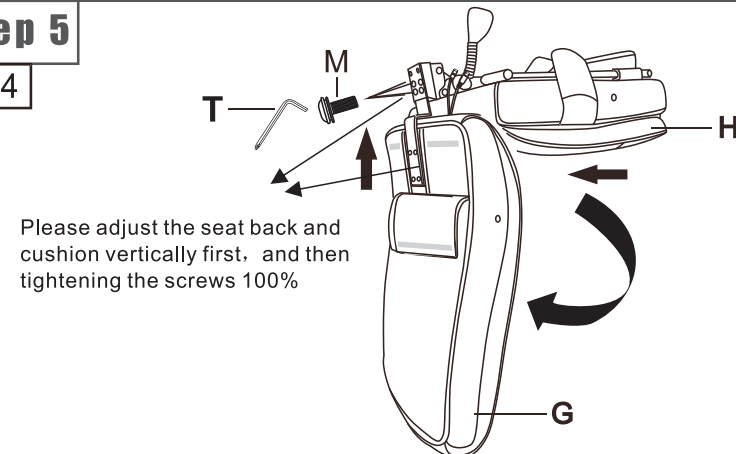

Please adjust the seat back and
cushion vertically first, and then
tightening the screws 100%

As shown in the figure, insert the other end of the connecting piece
'I' into the interface behind the cushion and fix it with 4 screws
numbered 'M'.