

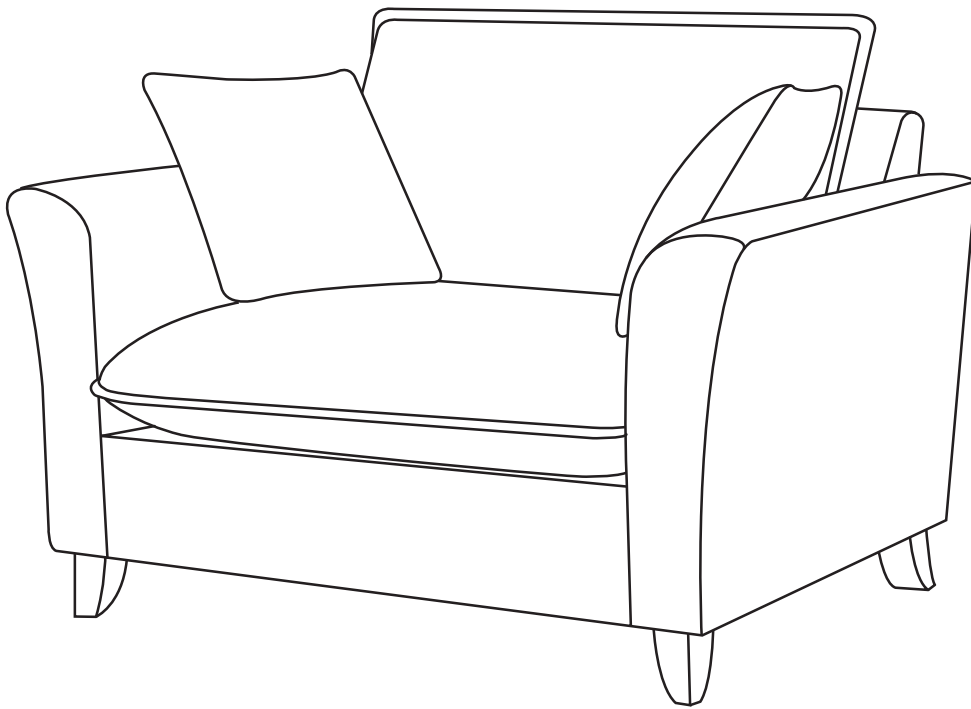









# ASSEMBLY INSTRUCTIONS

**Note: No climbing on the back of the chair!**



## Care & Maintenance





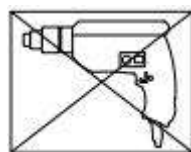

-  Do not put hot items directly on furniture surface
-  Do not clean furniture with harsh cleansers or polish
-  Do not place furniture under direct sunlight
-  Do not place furniture near heating or cooling vents
-  Do not write on furniture without a padded barrier to protect the surface
-  Do not place furniture outside. For indoor use only
-  Not for commercial use. For residential use only
-  Stains may be removed with mild soap solution and damp cloth
-  Children should not climb or jump on the furniture
-  Dust and pick-up spills using a clean, non-colored, lint-free cloth

## Caution

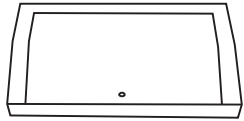
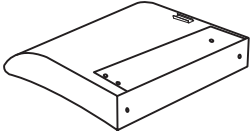
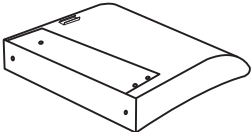
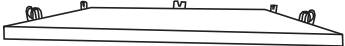

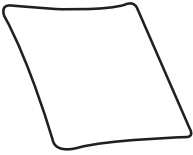
- This product contains small components. Please ensure that they are kept away from small children.
- Do not use power tools to assemble your furniture. Power tools may strip or damage the parts.



# PARTS LIST:

Label	Picture	Description	QTY
A		Backrest	1
B		Left Armrest	1
C		Right Armrest	1
D		Spring Seat Frame	1
E		Seat Cushion	1
F		Back Cushion	1
G		Arm Pillow	2
H		Front Leg	2
I		Back Leg	2
J		Front Rail	1

# HARDWARE LIST:

Label	Picture	Description	QTY
①		Plastic Washer	4
②		Rubber Washer	2
③		Allen Wrench (S5)	1

## Assembly Preparation:

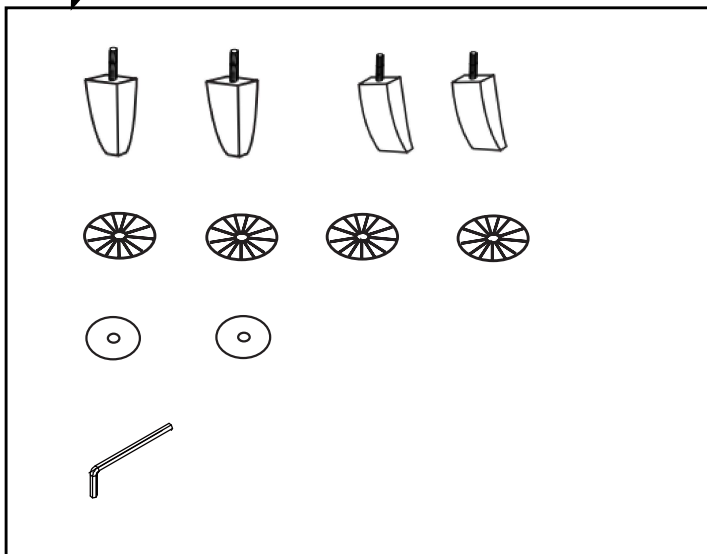
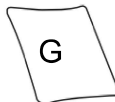
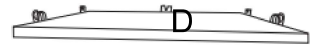
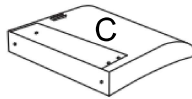
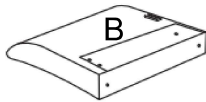
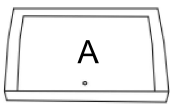

# ASSEMBLY STEPS:

## Step 1

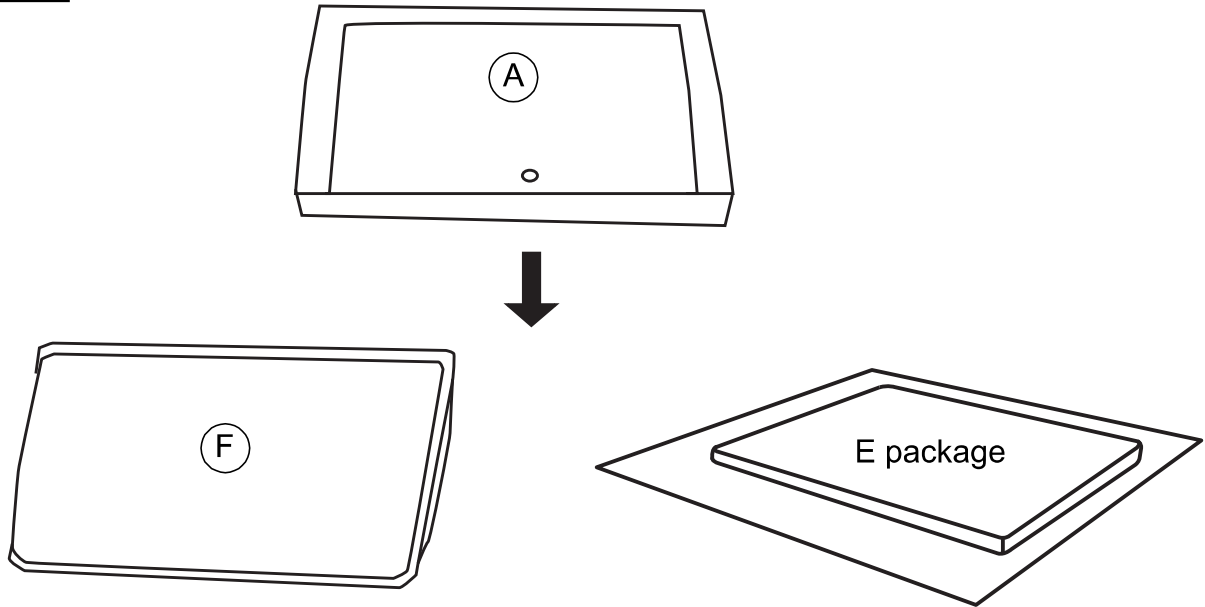

Take out the Back Cushion(F) and Seat Cushion (E)Package from Backrest (A).

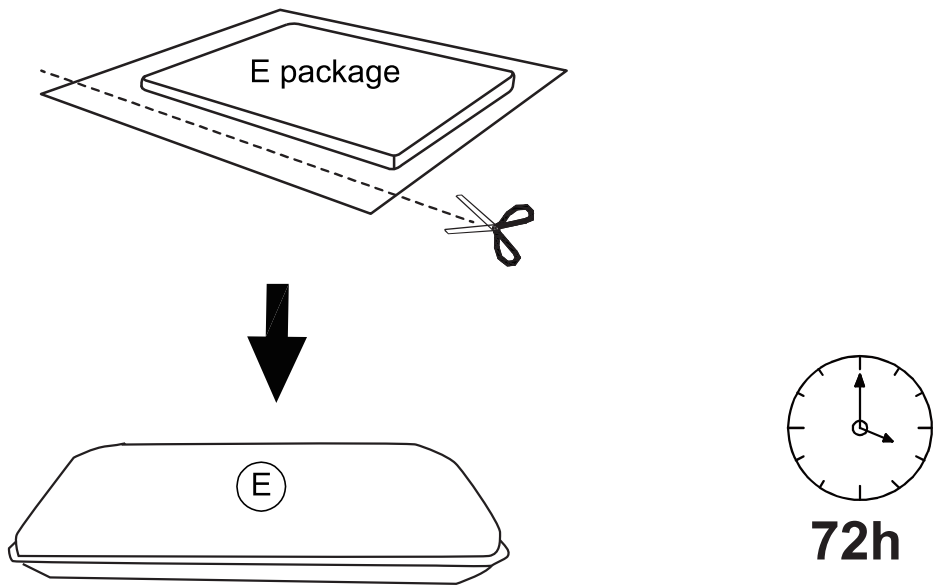

Step 2

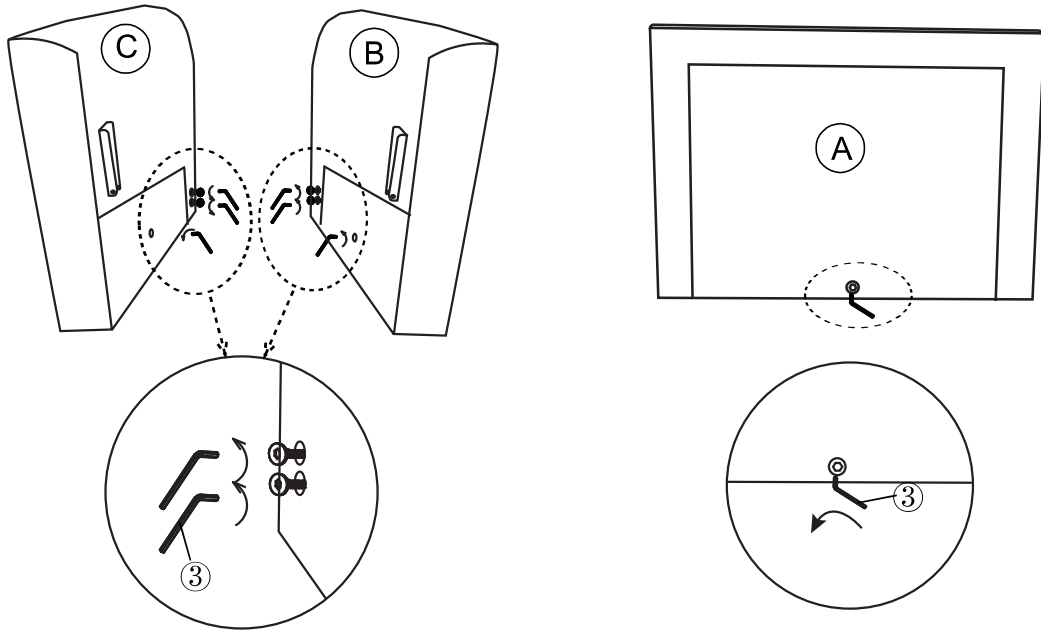

Loosen the bolts 50%.

Loosen the bolt 50%.

Step 3

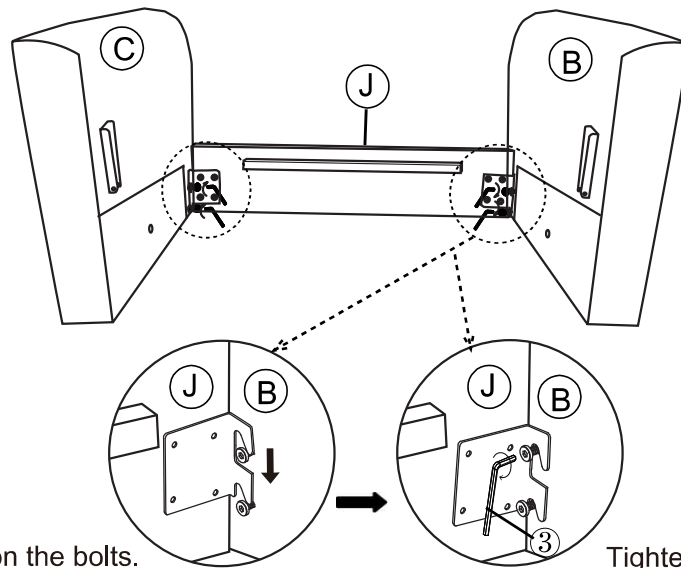

Hang on the bolts.

Tighten the bolts.

Step 4

Slide the Tapered Connectors on the Backrest(A) into the Tapered Connectors on the Left Armrest(B) and the Right Armrest(C) as shown.

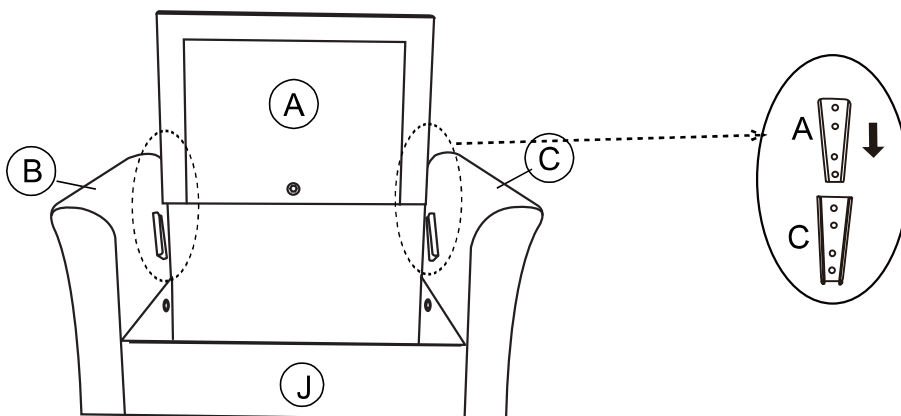

**Step 5**

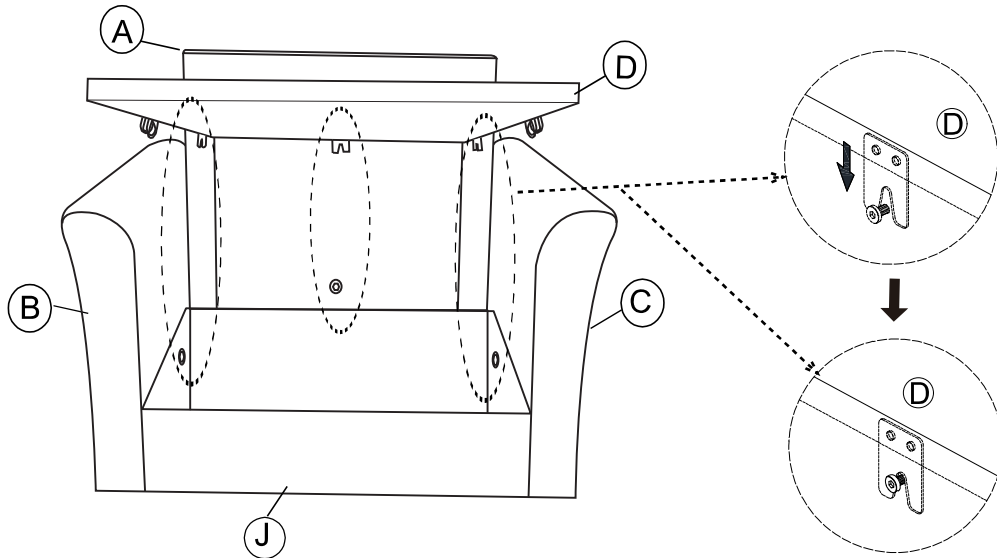

Put the Spring Seat Frame (D) on the chair.

**Step 6**

Tighten all the Bolts under the Spring Seat Frame(D) in this step.

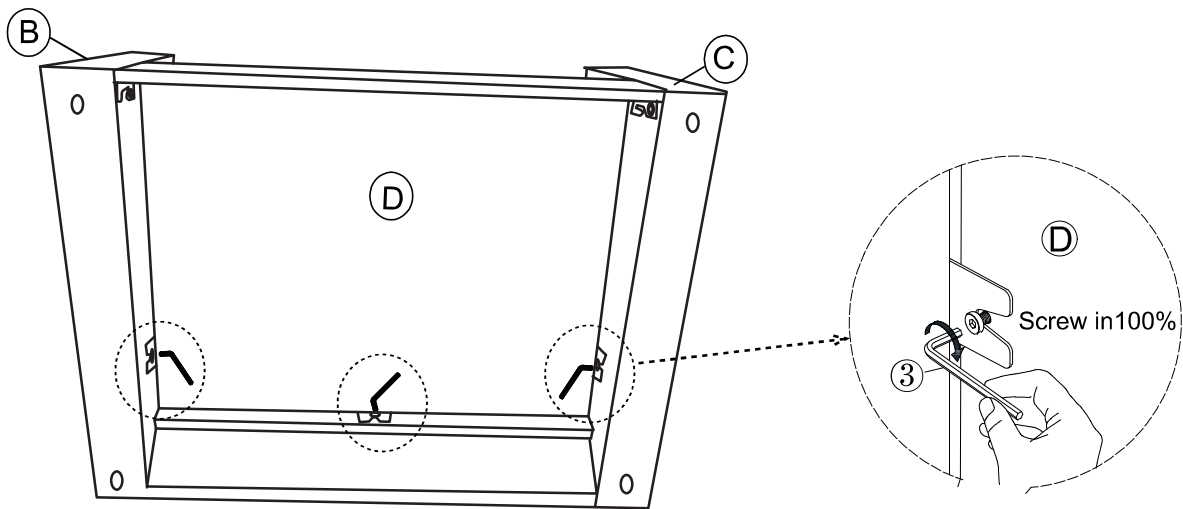

**Step 7**

Place one Plastic Washer(①) and Rubber Washer (②) on the Back Leg(I) screw, then insert screw into the mounting hole at the corner of the chair. Tighten by turning the leg clockwise as shown. Repeat the same steps to install the other Back Leg(I).

Place one Plastic Washer(①) and on the Front Leg(H) screw, then by the same method as Back Leg to install the Front Leg(H).

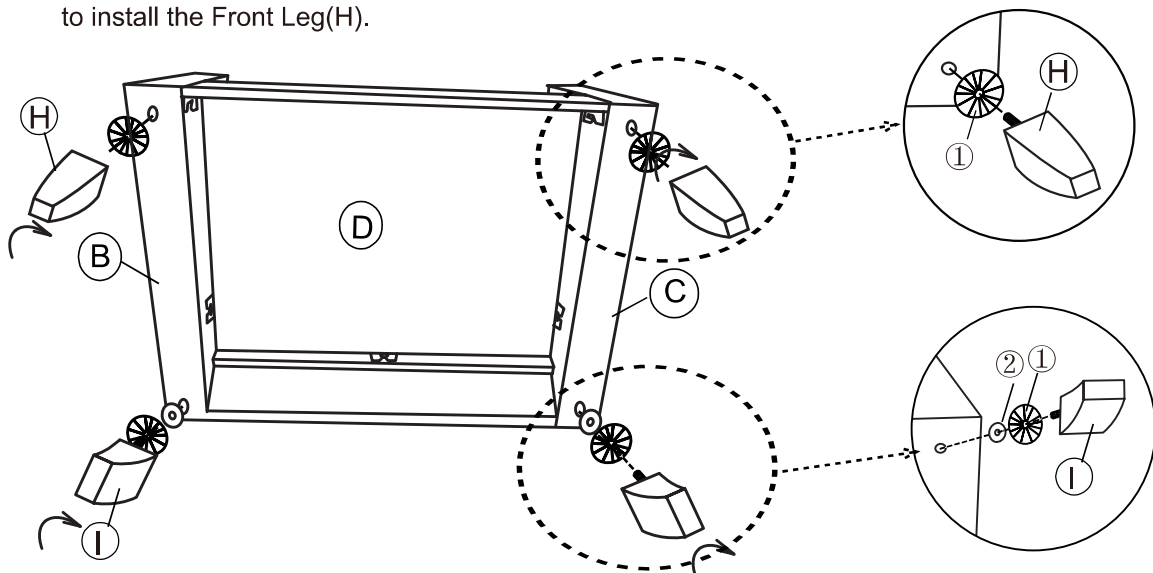

Step 8 Place the Seat Cushion(E) on the chair.

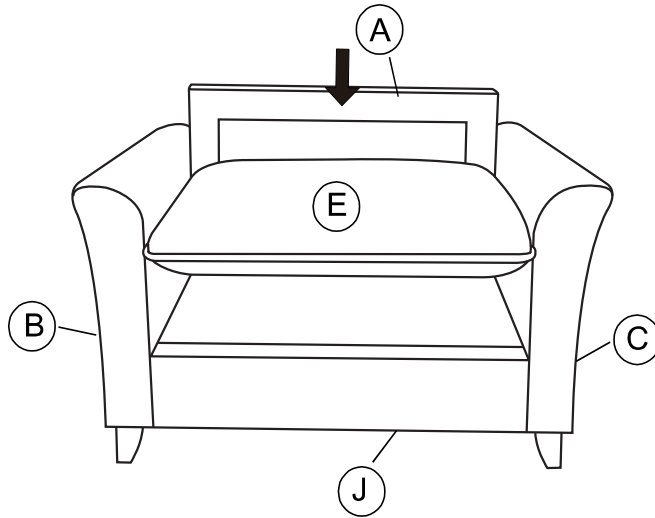

Step 9 Place the Back Cushion(F) and Arm Pillows(G) on the chair.

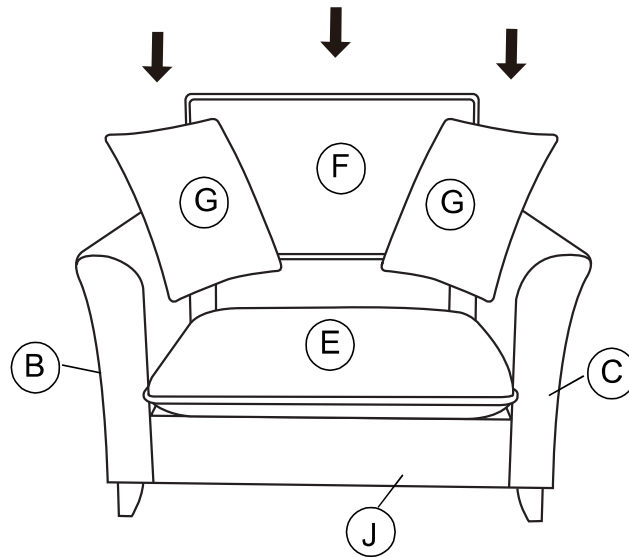

Step 10 Your Chair is ready for use.

