

"IMPORTANT, RETAIN FOR FUTURE REFERENCE: READ CAREFULLY"

German: WICHTIG, FÜR SPÄTERE NACHSCHLAGE AUFBEWAHREN: SORGFÄLTIG LESEN

Spanish: IMPORTANTE, GUARDAR PARA REFERENCIA FUTURA: LEER ATENTAMENTE

Italian: IMPORTANTE, CONSERVARE PER RIFERIMENTI FUTURI: LEGGERE ATTENTAMENTE

French: IMPORTANT, À CONSERVER POUR RÉFÉRENCE FUTURE : LIRE ATTENTIVEMENT



**Once installed, the product cannot be detached. Strictly follow each step in the installation manual.**

**EN**

1. Gather and organize all required parts prior to assembly.
2. Assemble on a flat, clean and soft surface.
3. Two or more people are needed for the assembly.
4. Align the holes before assembly and snap into place with a slight tap.
5. Please prepare rubber mallet in advance for convenient installation.
6. The product's structure prevents it from being conveniently assembled in low temperatures, so do not intentionally install at low temperatures.
7. During installation, please refer to the accessories guides to ensure that they are installed in the correct directions.

**Einmal installiert, kann das Produkt nicht mehr abgenommen werden. Befolgen Sie strikt alle Schritte in der Installationsanleitung.**

**DE**

1. Sammeln und organisieren Sie alle benötigten Teile vor der Montage.
2. Bauen Sie das Gerät auf einer flachen, sauberen und weichen Oberfläche zusammen.
3. Für den Zusammenbau werden zwei oder mehr Personen benötigt.
4. Richten Sie die Löcher vor der Montage aus und lassen Sie sie mit einem leichten Schlag einrasten.
5. Bitte bereiten Sie im Voraus einen Gummihammer vor, um die Montage zu erleichtern.
6. Die Struktur des Produkts verhindert eine bequeme Montage bei niedrigen Temperaturen, daher sollten Sie es nicht absichtlich bei niedrigen Temperaturen installieren.
7. Bitte beachten Sie während der Installation die Anleitungen für das Zubehör, um sicherzustellen, dass es in der richtigen Richtung installiert wird.

**Une fois que le produit a été installé, il ne peut pas être démonté. Veuillez suivre strictement chaque étape du manuel d'instructions pour le montage.**

**FR**

1. Récupérez et organisez toutes les pièces nécessaires avant le montage.
2. Le montage se fait sur une surface plane, propre et souple.
3. Il faut au moins deux personnes pour le montage.
4. Tapez légèrement sur les trous avant de les assembler et les pièces s'emboîteront.
5. Pour faciliter le montage, veuillez préparer à l'avance un maillet en caoutchouc.
6. La construction du produit empêche un montage facile à basse température, donc ne pas installer délibérément à basse température.
7. Pendant l'installation, veuillez vous référer au guide des accessoires pour vous assurer de l'orientation correcte de l'installation.

**Une fois que le produit a été installé, il ne peut pas être démonté. Veuillez suivre strictement chaque étape du manuel d'instructions pour le montage.**

**IT**

1. Raccogliere e organizzare tutte le parti richieste prima dell'assemblaggio.
2. Installare su una superficie piana, pulita e morbida.
3. E' necessario due o più persone per l'installazione.
4. Allineare i fori prima del montaggio e agganciare in posizione con un leggero tocco.
5. Si prega di preparare il martello di gomma in anticipo per una comoda installazione.
6. La struttura del prodotto impedisce l'assemblaggio a basse temperature, per cui non installare a basse temperature.
7. Durante l'installazione, fare riferimento alle guide degli accessori per assicurarsi che siano installati nelle direzioni corrette.









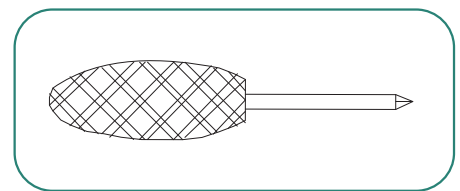

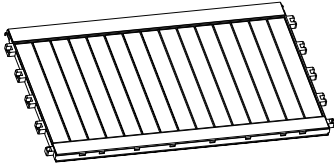

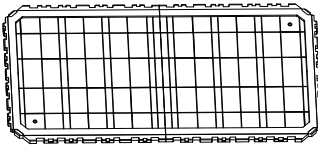

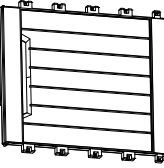
**Una vez instalado, el producto no se puede desmontar. Siga estrictamente cada paso del manual de instalación.**

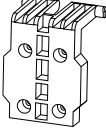
**ES**

1. Recoja y organice todas las piezas necesarias antes del montaje.
2. Monte en una superficie plana, limpia y suave.
3. Se necesitan dos o más personas para el montaje.
4. Alinee los agujeros antes del montaje y encaje con un ligero golpe.
5. Para facilitar la instalación, prepare de antemano un mazo de goma.
6. Debido a la construcción del producto, no lo monte a bajas temperaturas.
7. Durante la instalación, consulte la guía de accesorios para asegurar la orientación correcta de la instalación.

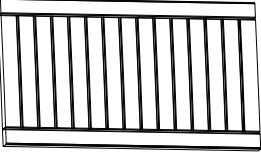
**Tools Required For Assembly**  
**Für die Montage benötigte Werkzeuge**  
**Outil Nécessaire Pour Le Montage**  
**Strumenti necessari per il montaggio**  
**Herramientas requeridas para el montaje**



Item no. Nr. N° d'article Articolo No. Artículo No.	Reference Image Referenzbild Image de référence Immagine di riferimento Imagen de referencia	Qty. Menge Qté. Qtà Cant.	Item no. Nr. N° d'article Articolo No. Artículo No.	Reference Image Referenzbild Image de référence Immagine di riferimento Imagen de referencia	Qty. Menge Qté. Qtà Cant.
<b>A</b>		X2	<b>H</b>		X2
<b>B</b>		X1	<b>I</b>		X1
<b>C</b>		X2	<b>T</b>		X1
<b>E</b>		X1	<b>Q</b>		X2
<b>G</b>		X4	<b>V</b>		X1
<b>G2</b>		X4	<b>J</b>		X1
			<b>U</b>		X32
			<b>L</b>	 1460*20*25mm	X1
			<b>L1</b>	 1370*30*15mm	X2

**1**

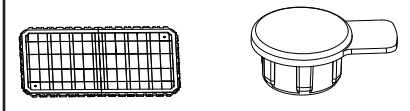

Ⓑ 1pc      Ⓚ 2pcs

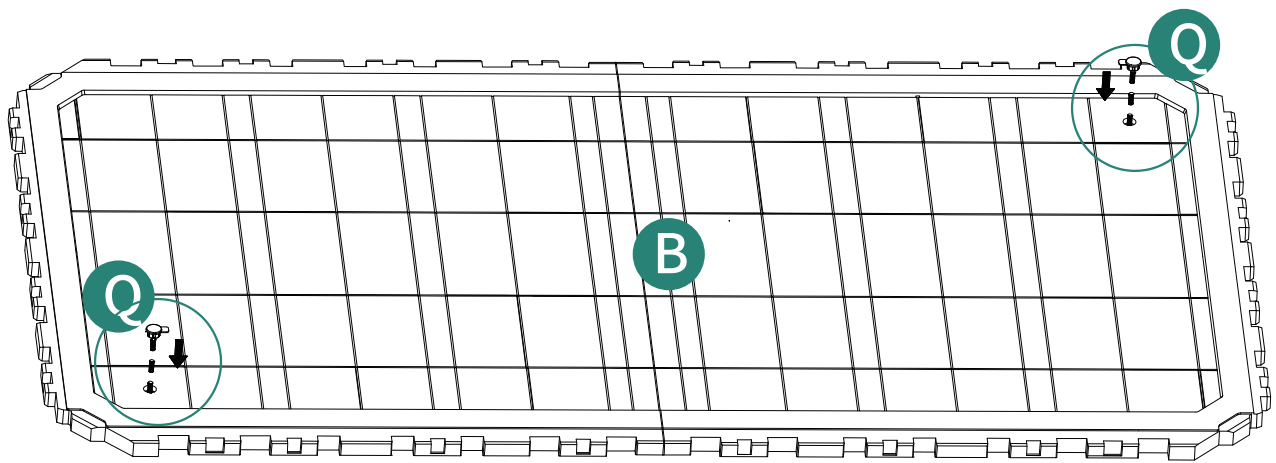
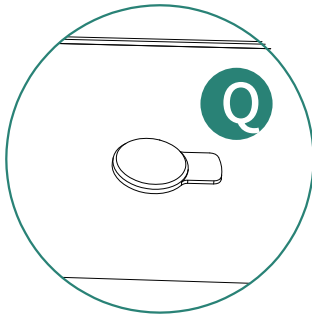

2

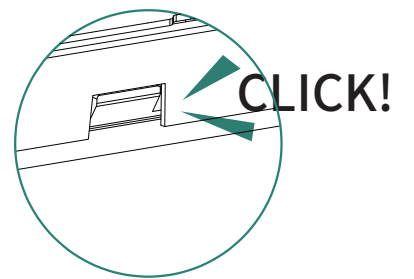
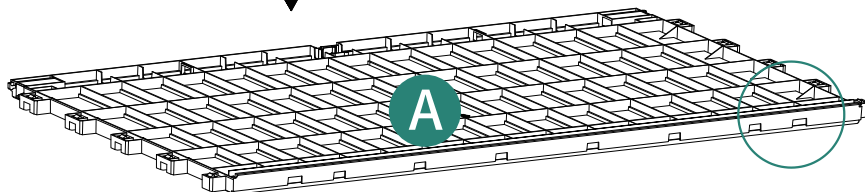
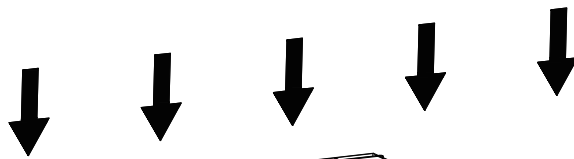
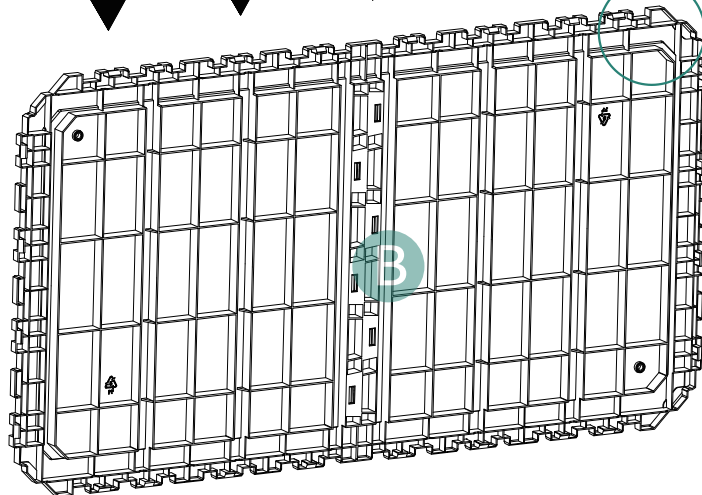
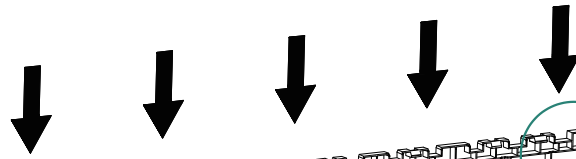
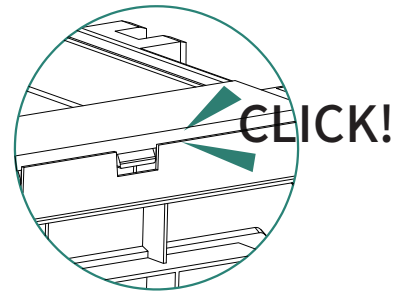
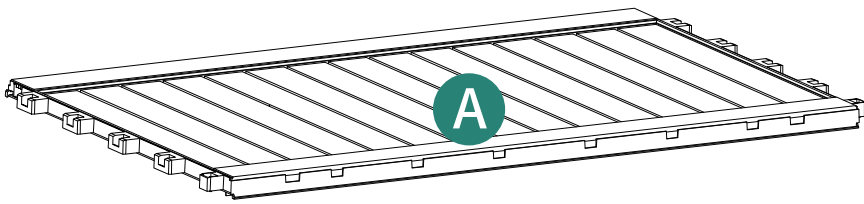
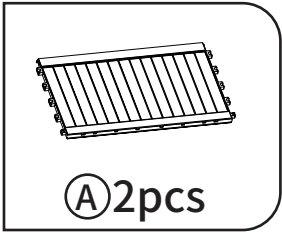

**3**  
**X2**

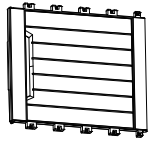

Ⓒ2pcs

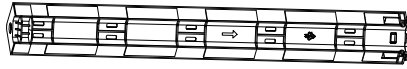

Ⓖ4pcs

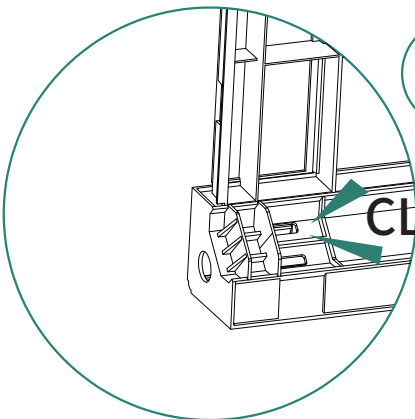
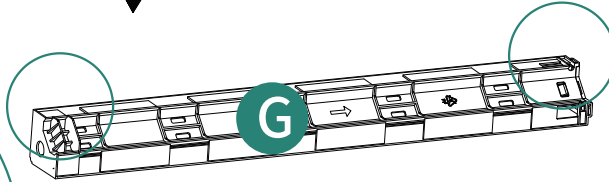
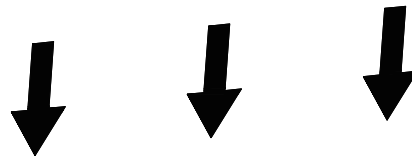
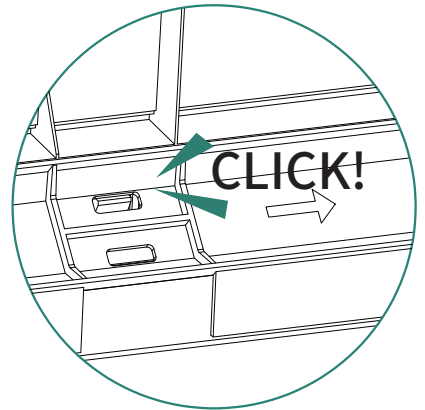
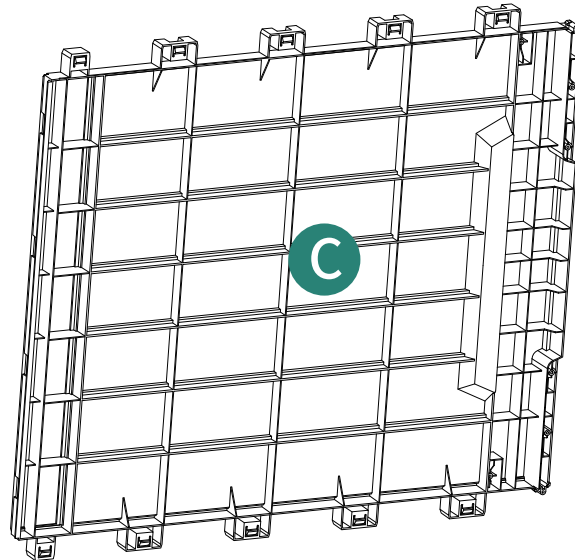
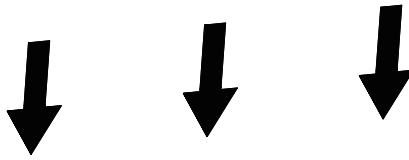

4

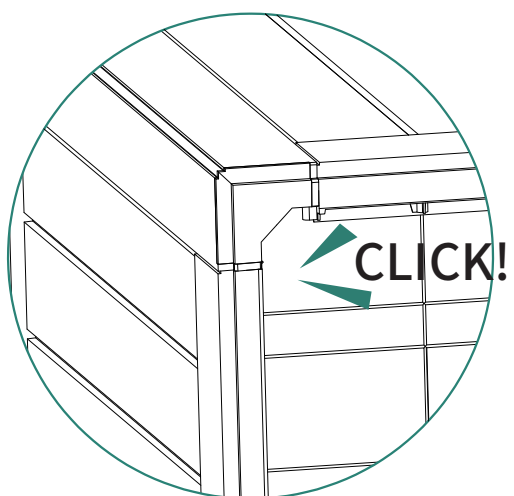
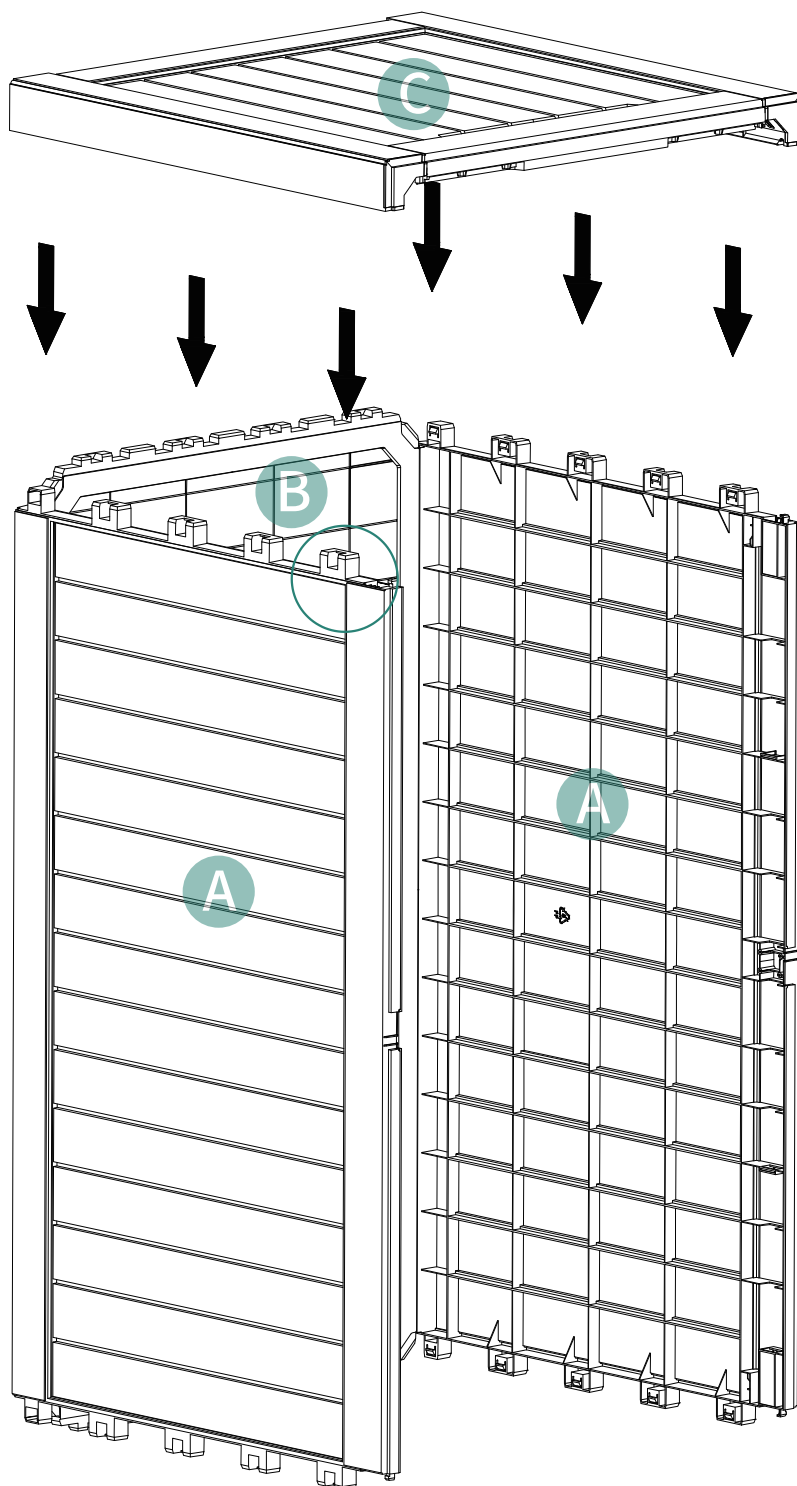

5

1370\*30\*15mm

(L1) 2pcs

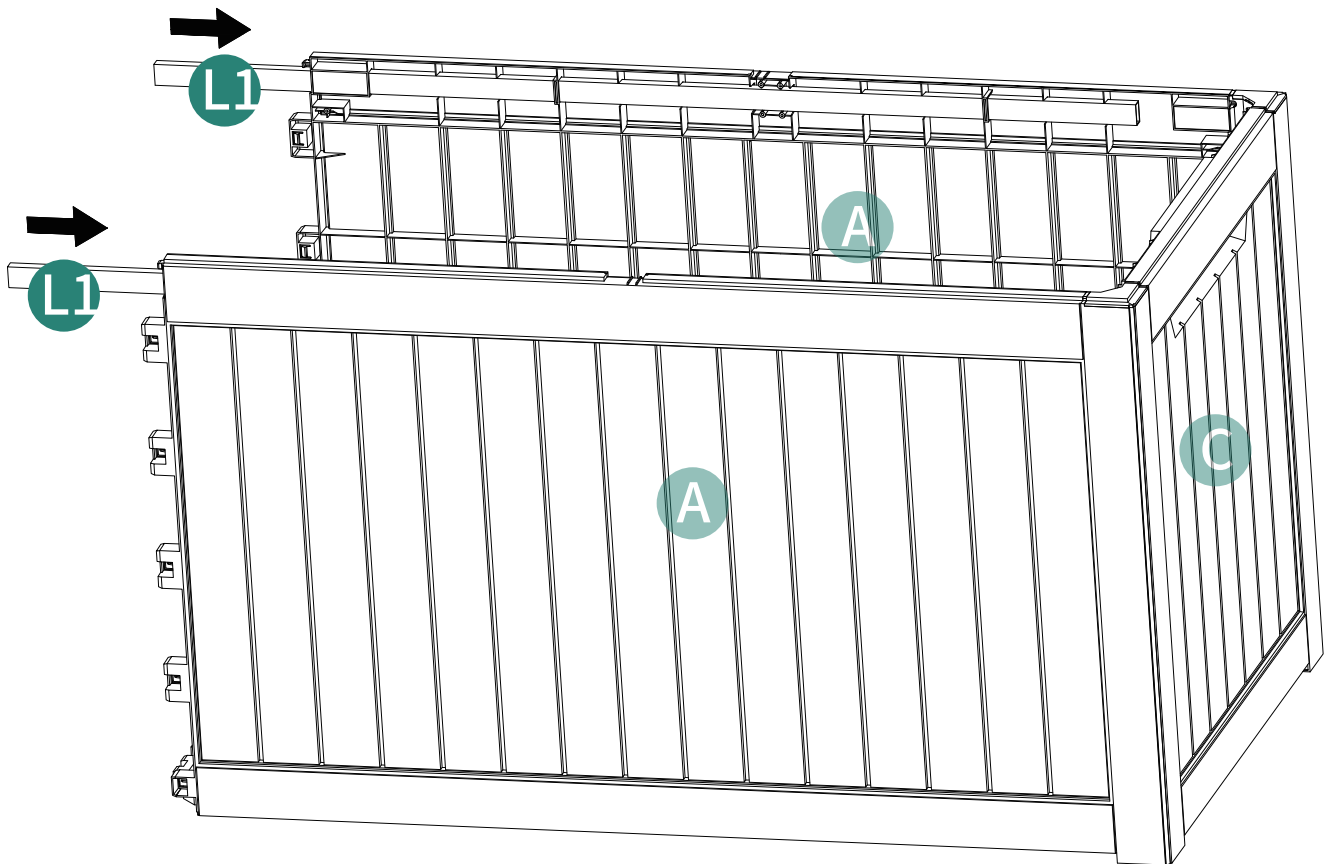

6

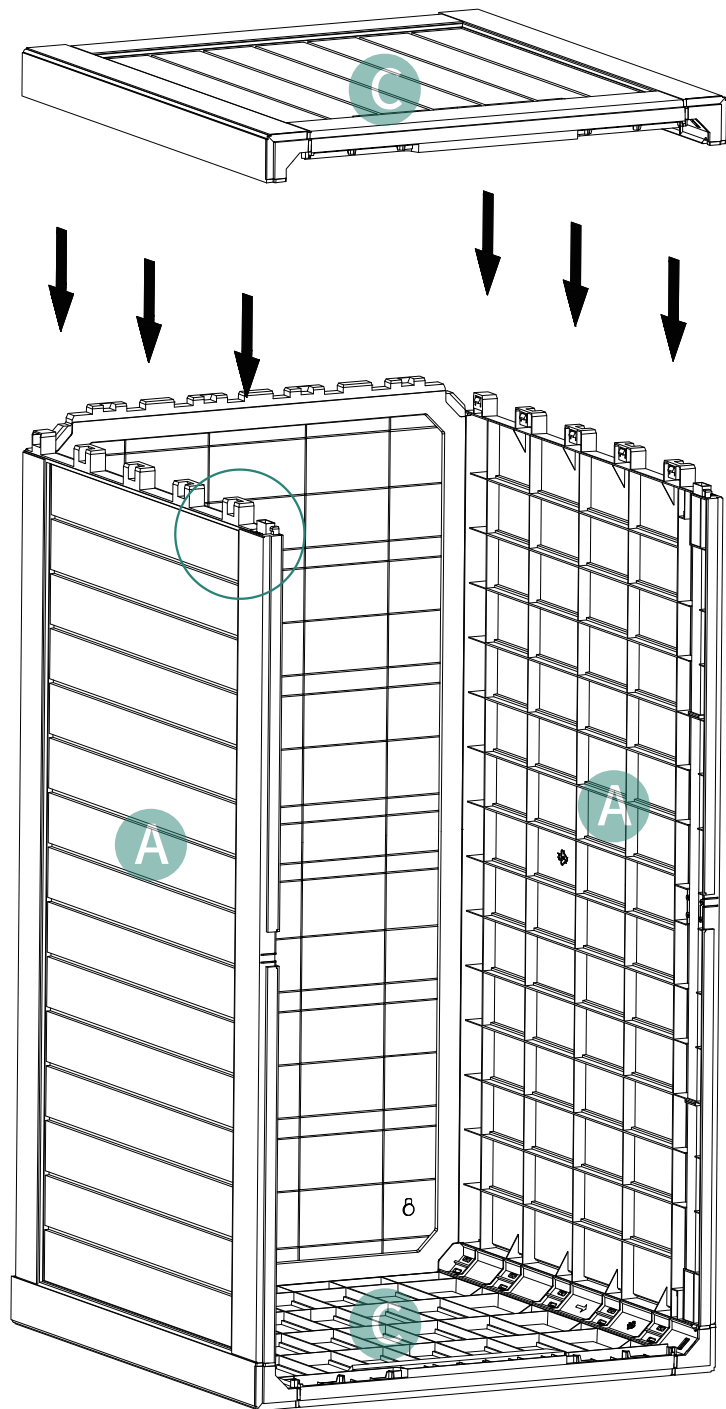
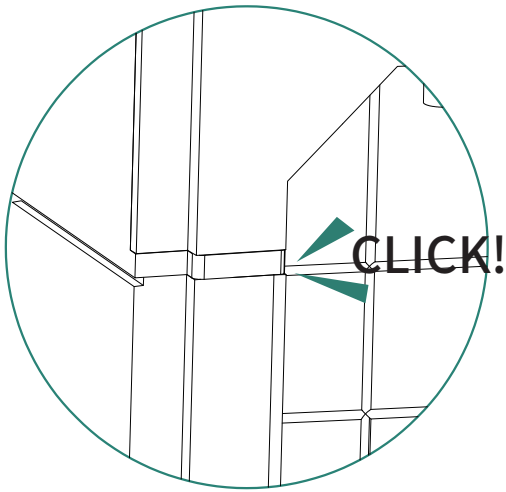

# 7

Ⓡ 1pc      Ⓣ 1pc      Ⓤ 3pcs

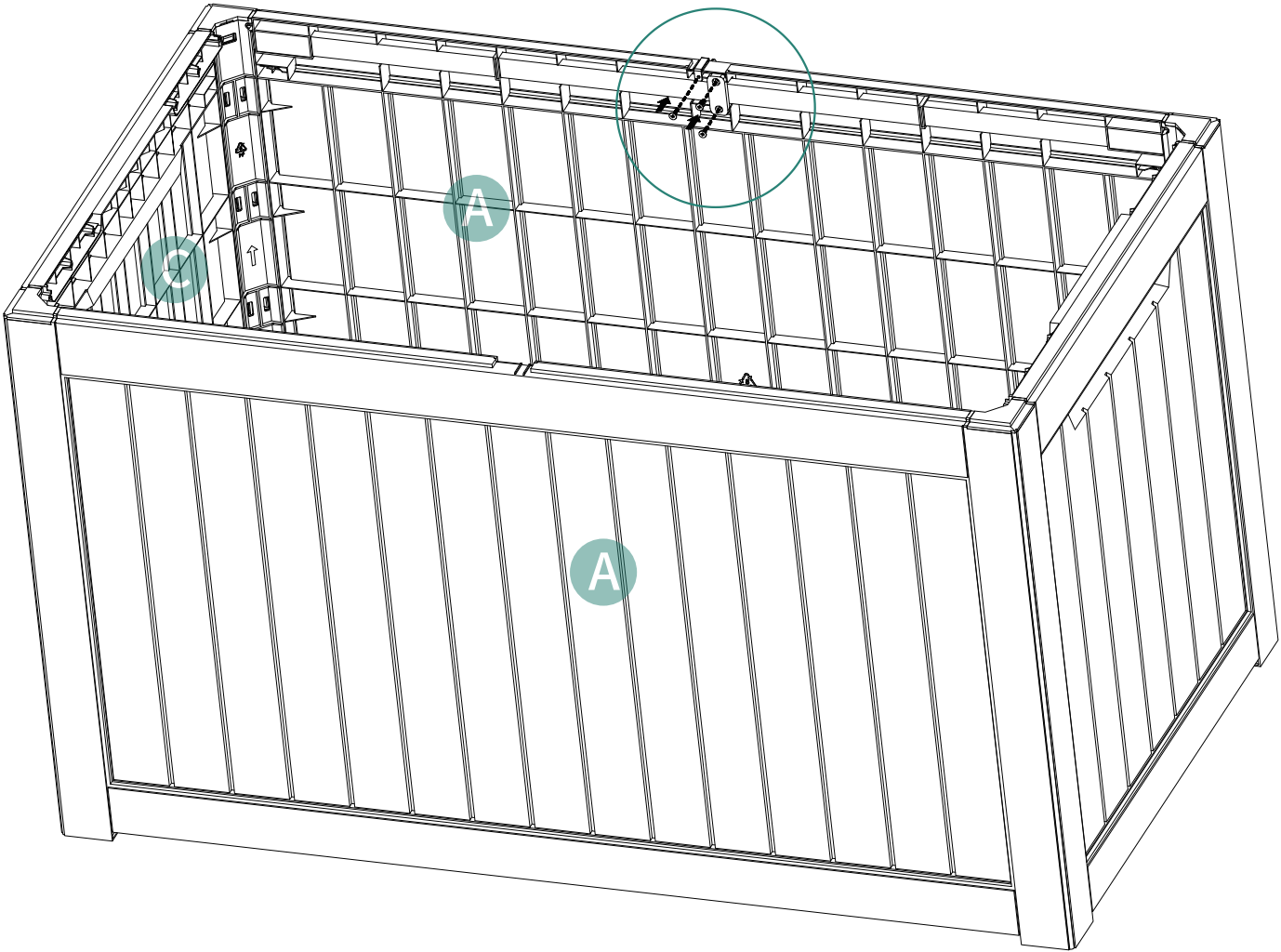
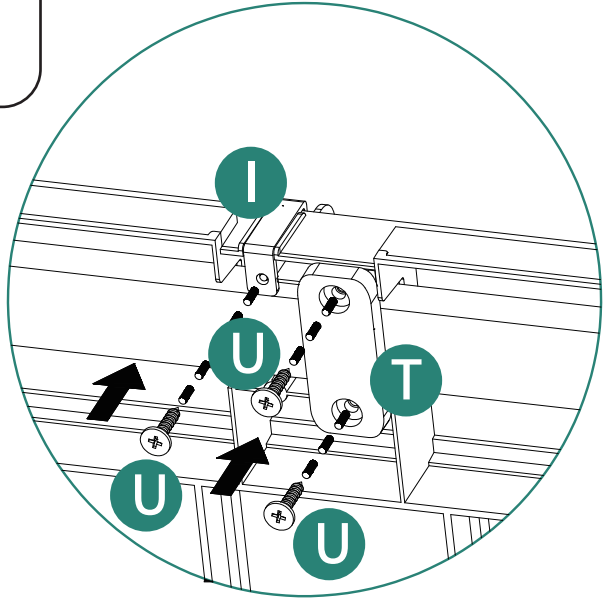

8

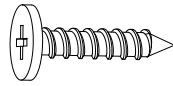

G2 4pcs

U 8pcs

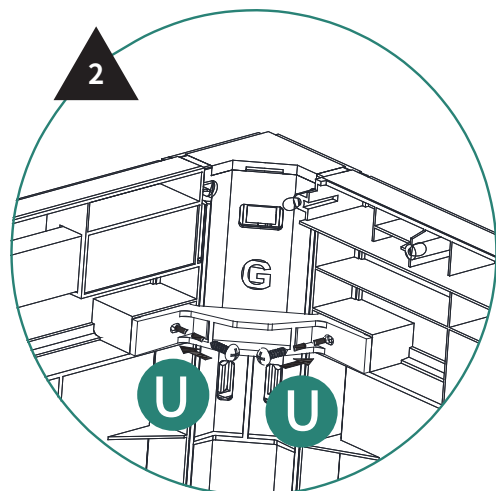
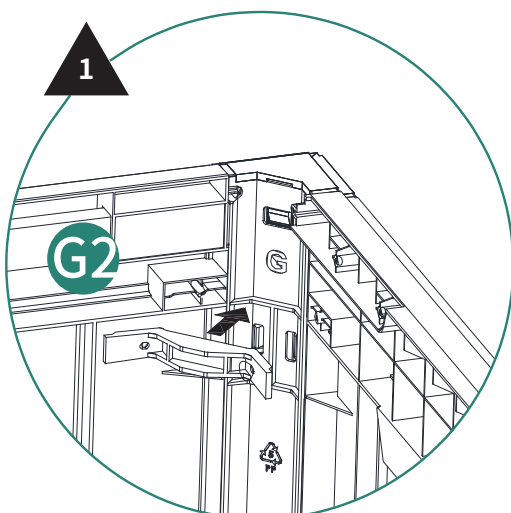
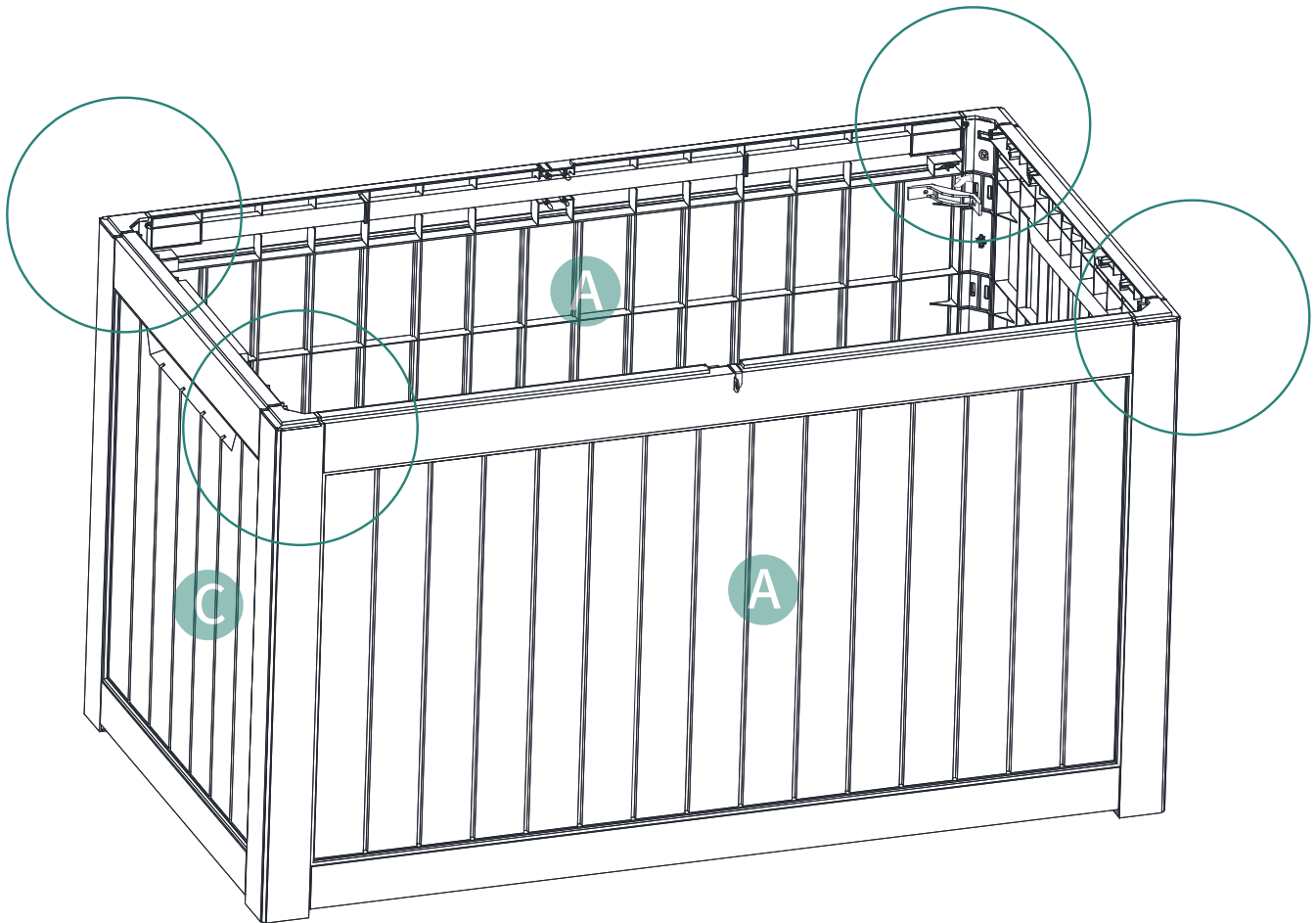

9



1460\*20\*25mm

Ⓛ 1pc

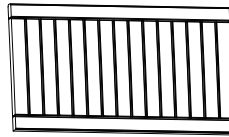

Ⓜ 1pc

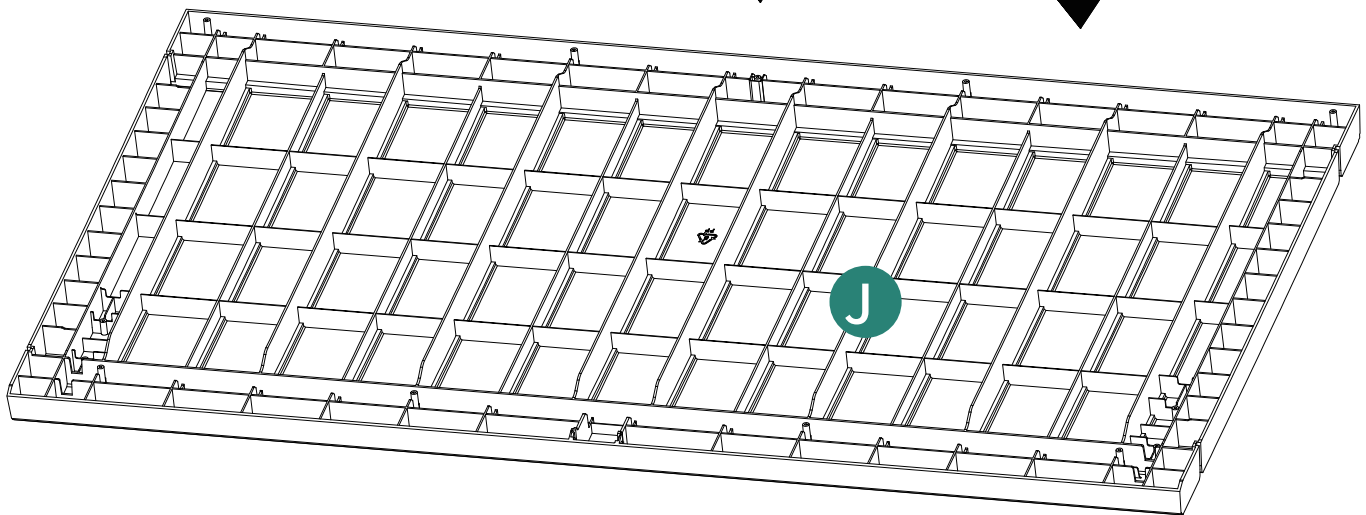
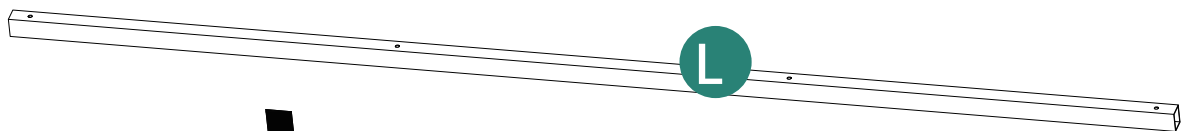

**10**

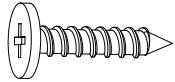

Ⓢ 4pcs

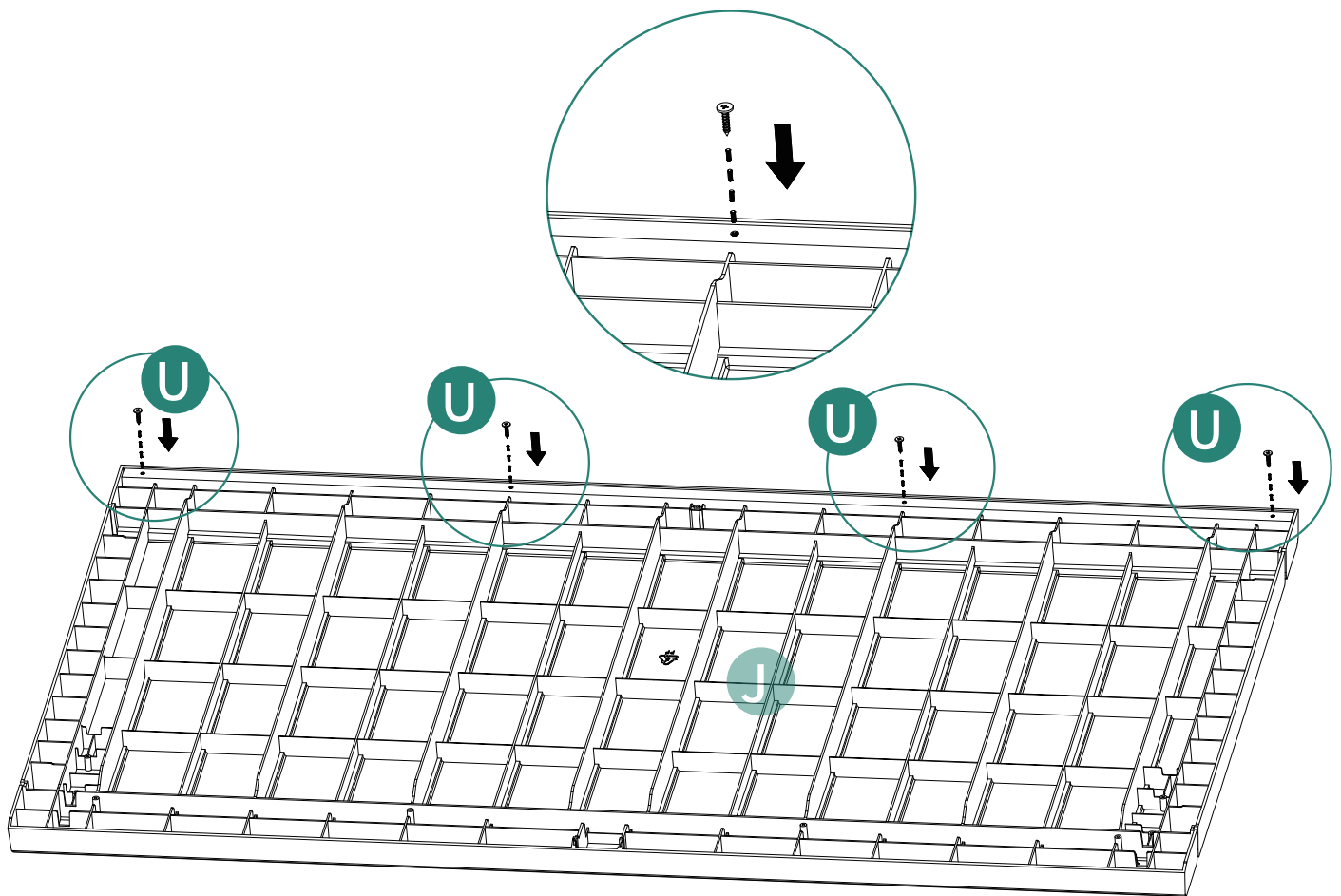

# 11

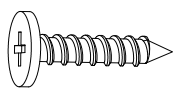

U 1pc

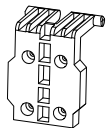

E 1pc



V 1pc

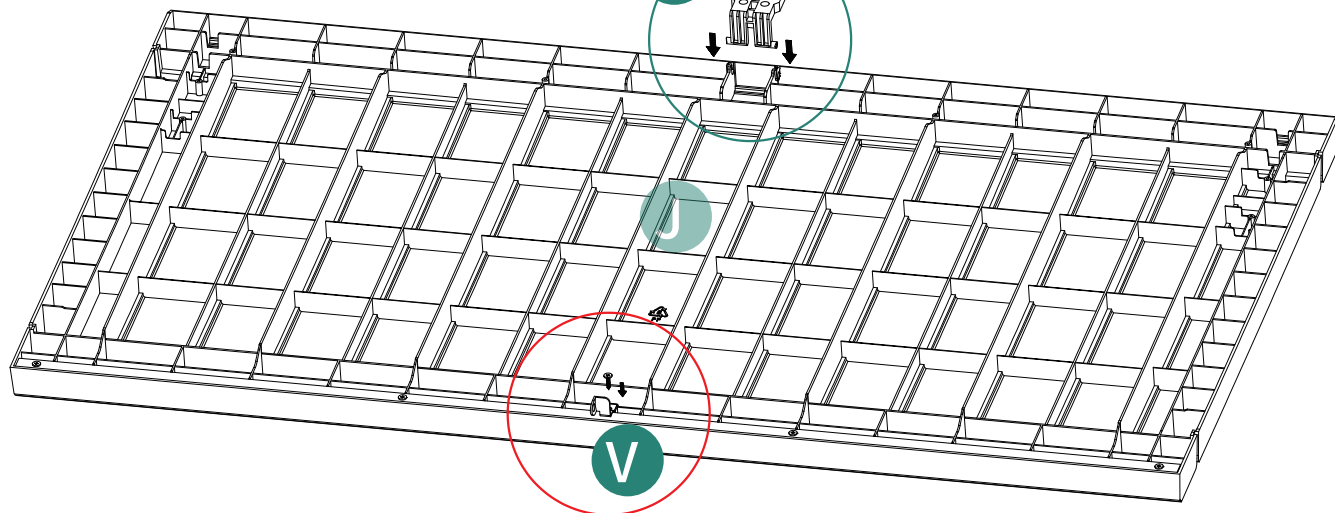
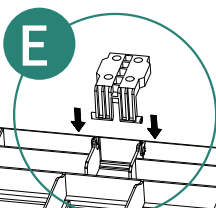
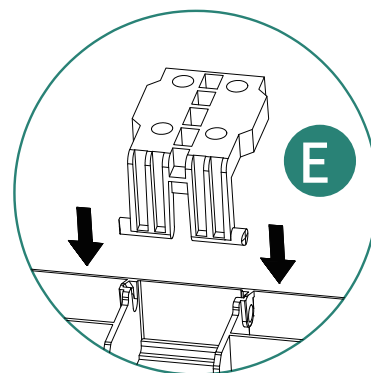
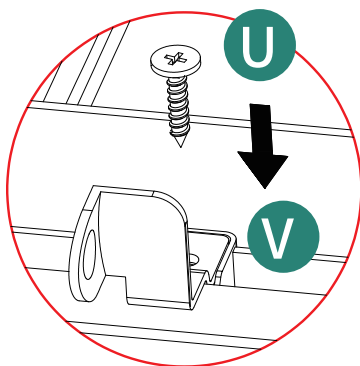

12

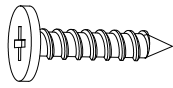

U 4pcs



H 2pcs

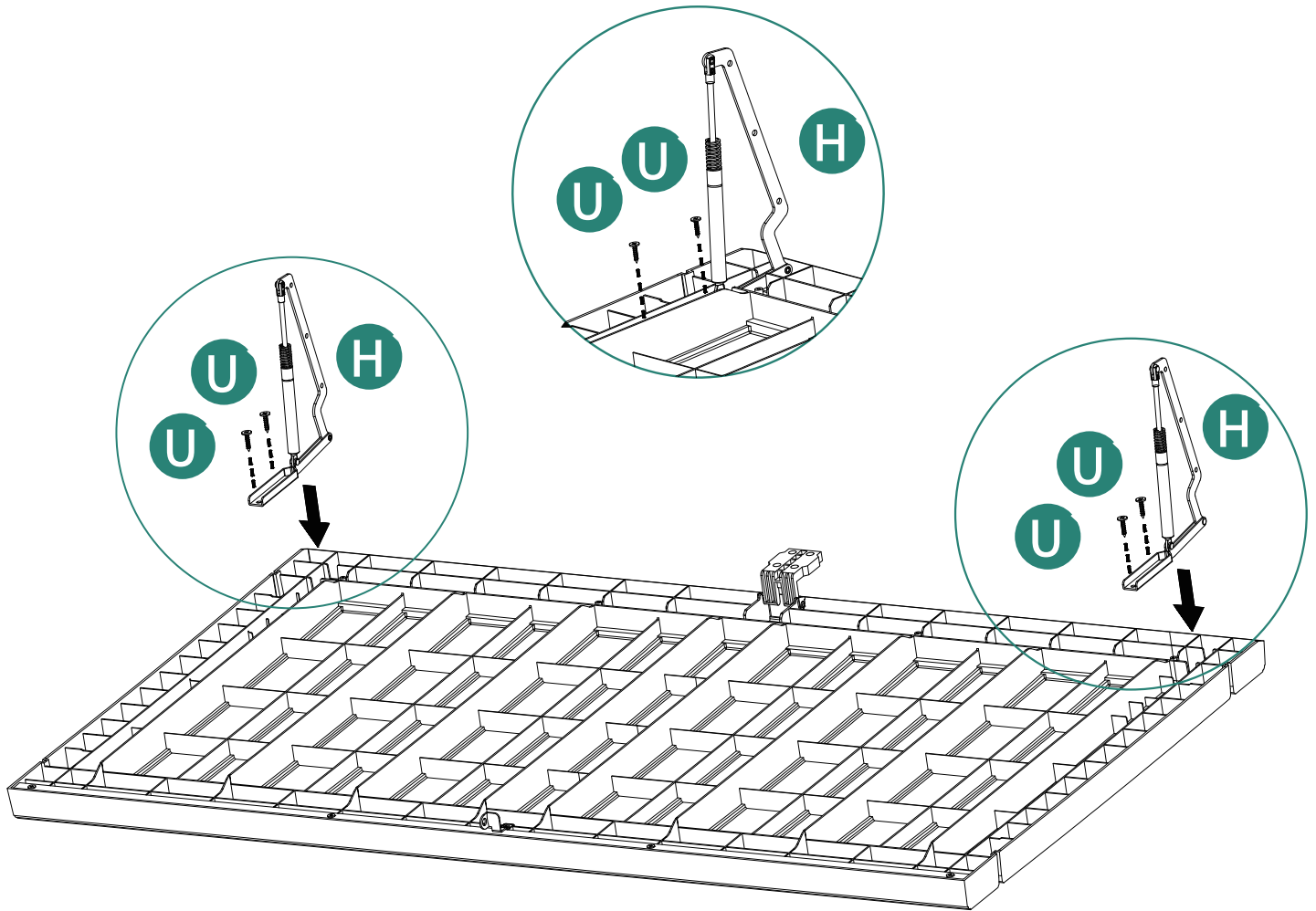

13

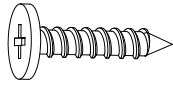

Ⓢ 10pcs

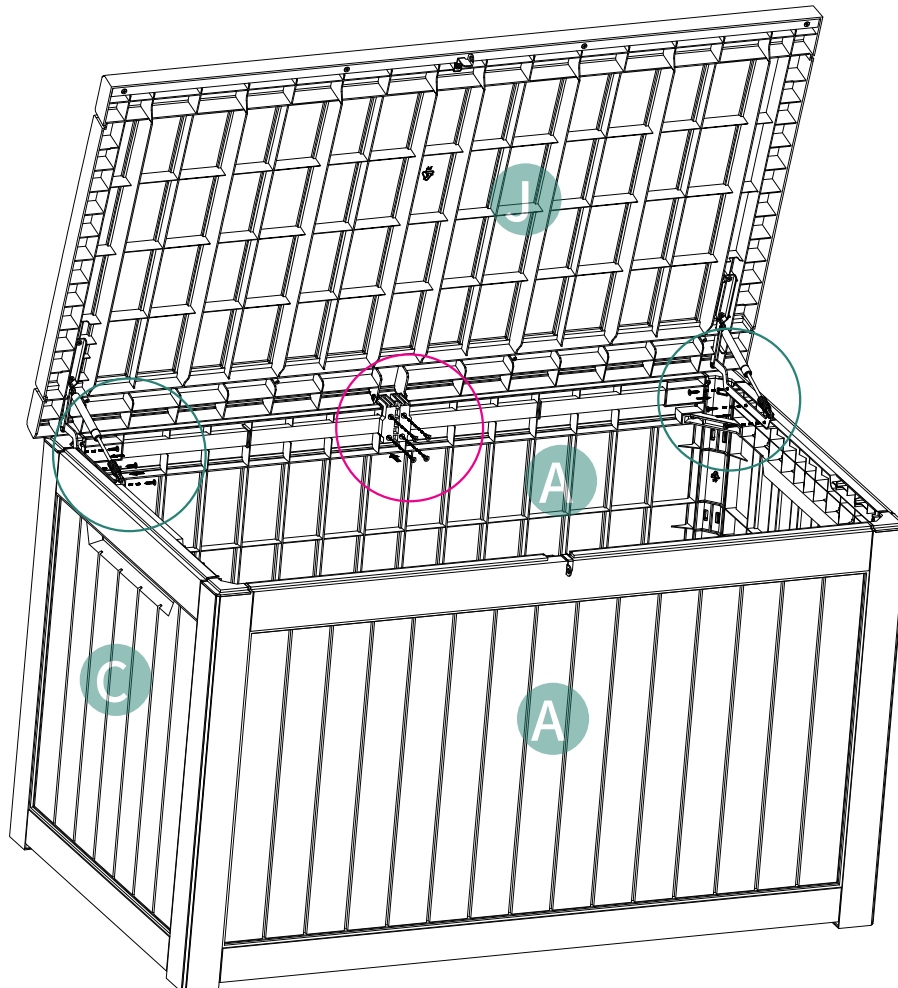
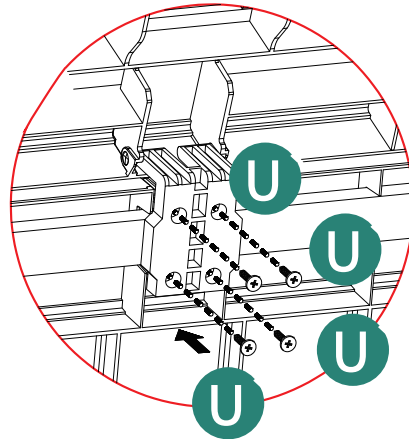
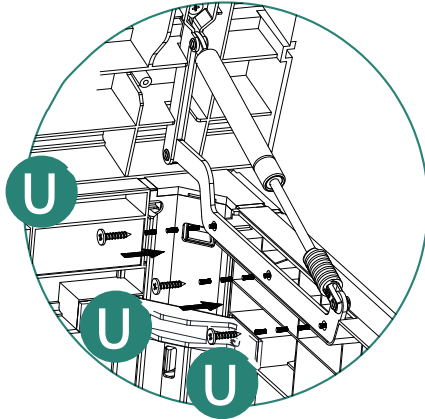

14

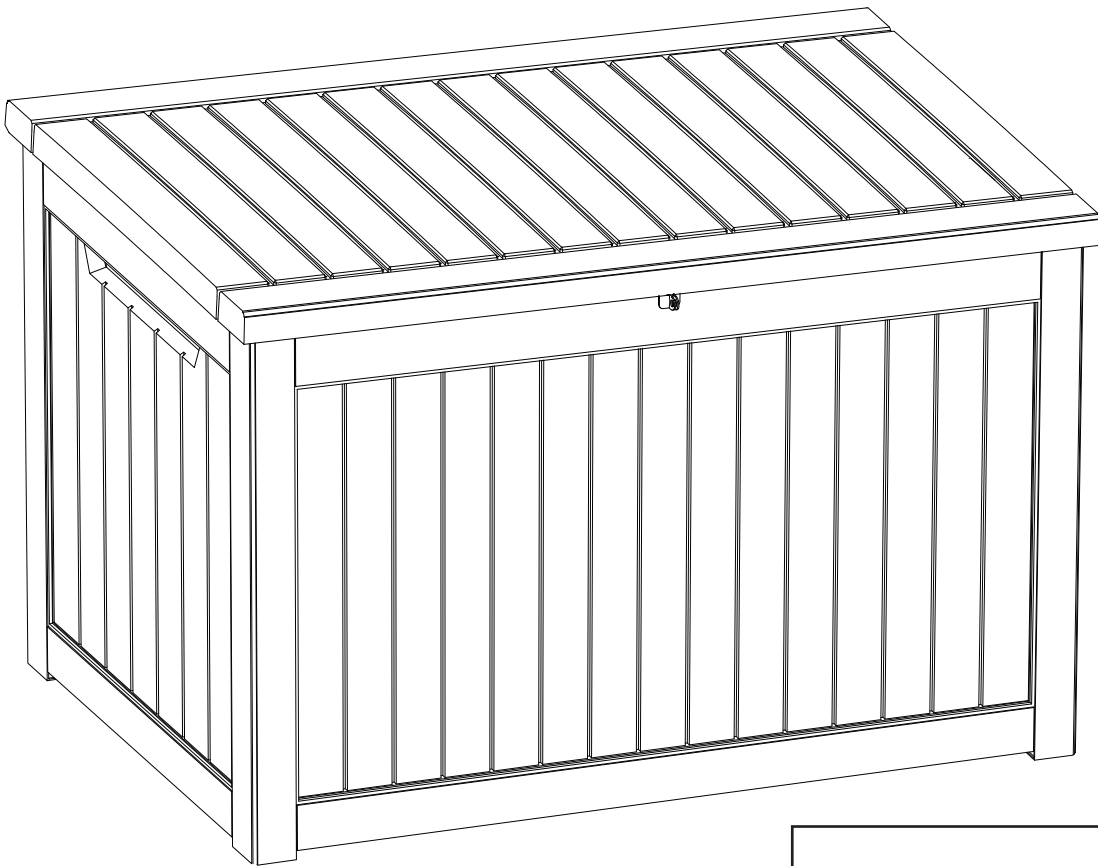

Installation Completed

Installation Abgeschlossen

Installation Complétée

Installazione Completata

Instalación Completada